



The Components You Need.

The Knowledge You Trust.

The Service You Deserve.

Since 1970, Specialty Sales has been a stocking distributor of hoses, tubing, couplings and fittings for companies in the water treatment, agriculture, lawn care, beverage and car wash industries. And while we certainly wouldn't say we've seen it all, we've seen a lot. With over 60 years of combined service in the industry, we're able to leverage our knowledge to help you find the right component or solution to solve your problems.

Manufacturing standards matter to us, even for the simplest products. Our dedication to quality products is why you won't find any knockoff or imposter products in our catalog. We wouldn't sell you something that we wouldn't use ourselves.

When you work with Specialty Sales, you'll find that we strive to do more.



HOSE

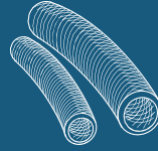

PVC Braided
PVC & EVA
Chemical Spray
Rubber General
Purpose Air & Water

PVC Suction
& Discharge
Rubber Suction
& Discharge

TUBING



PVC
Polyethylene (LLDPE)
Urethane (Ester / Ether)

Nylon
PEX

COUPLINGS



Thermoplastic
Cam-Operated
Metal Cam-Operated
Universal / Air King

FITTINGS



John Guest Push-Connect /
CTS
Metal Push-Connect
Plastic Pipe Fittings &
Nipples

Stainless Steel Pipe Fittings
& Nipples
Brass Fittings & Nipples
PVC Pipe Fittings & Nipples

CLAMPS



Punch-Type
Strapping & Buckles
Worm Gear
T-Bolt

Metal Pinch
Plastic Pinch
Cable Ties

VALVES



Plastic Push To Connect
Metal Push To Connect
Custom Configured
Metal Ball Valves

Plastic Ball Valves
Needle Valves
Drain Valves
Check Valves

MISCELLANEOUS



In-Line T-Strainers
Y-Strainers
Pressure Gauges
Teflon Tape

Hose & Tubing Cutters
Greases & Lubricants

PORTABLE EXCHANGE & DI



Culligan (Slip-Style)
Hose Connectors
Rayne (Yoke Style)
Park Fittings

PE / DI Tanks, Heads, Etc.
Bypass Valves
Tank Carts
Etc.

INDUSTRIAL ACCOUNT DATA SHEET



GENERAL COMPANY INFORMATION

Company Name: _____

Customer Number: _____

SECTION	PRICING CODE	PAGE	PRODUCT	DISCOUNT
Hose	2H	A1	Style 5000 – Grey Pureflex Water Hose	
Hose	2H	A2	Style 5015 – Clear Braided All Purpose PVC Hose – Food Grade	
Hose	2H	A3	Style 5016 – Clear Braided PVC General Purpose Hose	
Hose	2H	A4	Style 5220/5230 – Polyurethane/PVC Chemical Spray Hose	
Hose	2H	A5	Style 5240 – 600 PSI Ribbed PVC Spray Hose – Yellow	
Hose	2H	A6	Style 5260 – Natural Reinforced EVA Spray Hose	
Hose	1D	A7	Series 7092 – General Purpose Air & Water Hose – Red	
Hose	1D	A8	Series 7093 – General Purpose Air & Water Hose – Black	
Hose	2A	A9	Style 8040 – Green PVC Suction / Discharge Hose	
Hose	2A	A10	Style 8050 – Clear PVC Suction / Discharge Hose	
Hose	2A	A11	Style 8060 – Smooth Transparent PVC Food, Beverage and Dairy Handling Suction / Discharge Hose	
Hose	2A	A12	Style 8070 – Corrugated Transparent PVC Food, Beverage and Dairy Handling Suction / Discharge Hose	
Hose	1T	A13	Rubber Suction Hose	
Hose	2X	A14	PVC Wire Suction Hose	
Hose	1T	A15	PVC Layflat Discharge Hose	
Tubing	2T	B1	Style 05R – Industrial Grade Clear PVC Tubing	
Tubing	2T	B2	Style 05R Black – Black PVC Drain Line Tubing	
Tubing	2T	B3	Style 10 – Clear PVC Tubing – FDA Grade	
Tubing	2T	B4	Style 20 – Linear Low Density Polyethylene (LLDPE) Tubing	
Tubing	2J	B6	Style 20 – John Guest Linear Low Density Polyethylene (LLDPE) Tubing	
Tubing	2T	B7	Style 40 – Fuel Resistant PVC Tubing	
Tubing	2T	B8	Style 45 – Premium Grade PVC Tubing 60 Durometer	
Tubing	2T	B9	Style 50 – Premium Grade PVC Tubing 70 Durometer	
Tubing	2T	B10	Style 60 – Urethane Tubing (Ester Based)	
Tubing	2T	B11	Style 65 – Urethane Tubing (Ether Based)	
Tubing	2T	B12	Style 75 – Nylon Tubing	
Tubing	2T-SB	B14	Shark-Bite PEX Tubing	
Couplings	4Z	C1	Cam-Operated Couplers and Adapters	
Couplings	4G	C12	Cam-Operated Coupling Gaskets & Shims	
Couplings	3A	C13	Metal Cam-Operated Couplers and Adapters	
Couplings	3A	C18	“Air King” Universal Coupling – Air Service Only	
Fittings	8J	D1	John Guest Auto-Lock Acetal Push Connect Fittings	
Fittings	8J	D19	John Guest Superseal Fittings	
Fittings	8J	D21	John Guest Metric Acetal Push Connect Fittings	
Fittings	8J	D35	John Guest Ag Air Equipment Repair Kit	
Fittings	8J	D37	John Guest Polypropylene Push Connect Fittings – White	
Fittings	8J	D46	John Guest White Polypropylene Service & Repair Kit	
Fittings	8J	D47	John Guest Polypropylene Push Connect Fittings – Black	
Fittings	8J	D51	John Guest Black Polypropylene Service & Repair Kit	
Fittings	8J	D52	John Guest Ag Liquid Equipment Repair Kit	
Fittings	8J-PF	D53	John Guest Speedfit Plumbing Fittings – White	
Fittings	8J-PF	D59	John Guest Speedfit Plumbing Fittings – Black	
Fittings	8J-PL	D63	John Guest ProLock Plumbing Fittings	
Fittings	8J-SB	D67	Shark Bite Brass Plumbing Fittings	
Fittings	8S	D75	SeaTech / AquaLock™ Plumbing Fittings	
Fittings	7H	D81	Stainless Steel Push-In Fittings	

SECTION	PRICING CODE	PAGE	PRODUCT	DISCOUNT
Fittings	7H	D83	Nickel-Plated Push-In Fittings	
Fittings	8A	D85	Plastic Hose Barb & Pipe Fittings	
Fittings	7A	D107	Brass Fittings	
Fittings	8T	D139	Schedule 80 Polypropylene Pipe Fittings	
Fittings	7T	D145	316 Stainless Steel Hose Barbs	
Fittings	7M	D147	Stainless Steel Pipe Fittings	
Fittings	7M	D153	Stainless Steel Pipe Nipples	
Fittings	8X	D157	Spears PVC Fittings	
Clamps	5F	E1	F Series – Punch-Type Clamps	
Clamps	5F	E2	K Series – Universal Clamps	
Clamps	5F	E3	Fast-Lok Clamp-It Strapping and Buckles	
Clamps	5F	E4	Fast-Lok Clamping Tools & Tool Parts	
Clamps	5I	E5	IDEAL Worm Gear Clamps	
Clamps	5T	E6	TRIDON Miniature Worm Gear Clamps	
Clamps	5I	E7	POWR-GEAR® 60 High Performance Clamps	
Clamps	5X	E8	IDEAL T-Bolt Clamps	
Clamps	5P	E9	Easy Seal Ny-Glass Hose Clamps	
Clamps	5O	E11	Oetiker 1-Ear Clamps	
Clamps	5O	E12	Oetiker 2-Ear Clamps	
Clamps	5O	E13	Oetiker StepLess® Ear Clamps	
Clamps	5O	E14	Oetiker Tools & Kits	
Clamps	5G	E15	Cable Ties	
Clamps	7F	E17	Brass Ferrules	
Valves	6J	F1	John Guest Polypropylene Shut-Off Valves: White	
Valves	6J	F3	John Guest Polypropylene Shut-Off Valves: Black	
Valves	6J	F4	John Guest Acetal Shut Off Valves: Gray	
Valves	6J-PL / 6J-PF	F5	John Guest Plumbing Fitting Shut Off Valves	
Valves	6J	F6	John Guest Acetal Check Valves	
Valves	6J	F7	John Guest Angle Stop Adapter Valves	
Valves	6J-SB	F9	Shark Bite Brass Ball Valves & Check Valves	
Valves	6S	F11	Specialty Valves	
Valves	6R	F53	Brass Ball Valves: Style 54 – Full Port	
Valves	6R	F54	Lead Free Brass Ball Valves: Style 54 – Full Port	
Valves	6R	F55	Lead Free Brass Ball Valves: Style 42 – Full Port Sweat	
Valves	6R	F56	Brass Ball Valves: Style 93 – Full Port Hot-Forged Brass Exhaust Ball Valves With Lockable Handles	
Valves	6R	F57	RuB Miniature Ball Valves	
Valves	6M	F59	Stainless Steel Ball Valves	
Valves	6T	F63	Polypropylene Ball Valves	
Valves	6Q	F65	PVC Ball Valves	
Valves	6B	F67	PVC Spring Check Valves	
Valves	6A	F69	Needle & Misc Brass Valves	
Valves	6A	F71	Shut Off Cocks	
Valves	6A	F73	Drain Cocks & Drain Valves	
Misc	9R	G1	In-Line Strainers	
Misc	9R	G6	In-Line Strainer Spare Parts	
Misc	9R	G10	Suction Screens	
Misc	9B	G11	Polypropylene Y Strainers	
Misc	9P	G13	Pressure Gauges	
Misc	9T	G27	PTFE Thread Tape	
Misc	2X/8J	G29	Hose & Tubing Cutters	
Misc	9J	G31	Greases & Lubricants	

CUSTOMER ONBOARDING



GENERAL COMPANY INFORMATION

Company Name: _____

Billing/Mailing Address: _____

Telephone: _____ Tax ID: _____

Are you Tax-Exempt: Yes No

If yes, please provide Tax Exempt certificate for all planned Ship-To states.

PURCHASING

Primary Contact Name: _____

Primary Contact Email: _____

Primary Contact Phone: _____

ACCOUNTS PAYABLE

Email for Invoices: _____

Contact Name: _____

Contact Email: _____

Contact Phone: _____

Will you be applying for Credit Terms? Yes No

If yes, please fill out a Credit Application form. If no, please fill out a Credit Card Authorization form.

SHIPPING

Default Shipping Address: _____

(Cannot be a PO Box) _____

Default Shipping Preferences: Best Way UPS Collect, Collect # _____

Other: _____

OTHER

Any Other Special Instructions?

Please indicate any other information you feel is important to note on your account.

I Agree to the Specialty Sales Terms & Conditions

Printed Name: _____ Signature: _____

Title: _____ Date: _____

**THIS PAGE IS
INTENTIONALLY
LEFT BLANK**

CREDIT CARD PRE-AUTHORIZATION/ SIGNATURE ON FILE FORM



I, _____ authorize Specialty Sales LLC to charge my credit card below for agreed upon purchases. I understand that my credit card information will be saved to file for future transactions on my account.

CREDIT CARD INFORMATION

Company: _____

Cardholder Name: _____

Billing Address: _____

(Mark One): Visa Mastercard American Express

Credit Card Number: _____

Expiration Date: ____ / ____

Security Code: _____

Signature Of Authorized Cardholder:

**THIS PAGE IS
INTENTIONALLY
LEFT BLANK**

CREDIT APPLICATION



Company Name: _____

Contact Name: _____

Contact Email: _____

Contact Phone: _____

Date: _____

Please list a minimum of 3 credit/ trade references.
All information must be complete for each reference, including email address.

REFERENCE #1

Company Name: _____

Individual Name: _____

Email Address: _____

Phone Number: _____

REFERENCE #2

Company Name: _____

Individual Name: _____

Email Address: _____

Phone Number: _____

REFERENCE #3

Company Name: _____

Individual Name: _____

Email Address: _____

Phone Number: _____

REFERENCE #4

Company Name: _____

Individual Name: _____

Email Address: _____

Phone Number: _____

**THIS PAGE IS
INTENTIONALLY
LEFT BLANK**

TERMS & CONDITIONS



ORDERING: Orders may be placed by phone, email, or through our website. All orders are required to have at the minimum: customer PO number, Specialty Sales' or manufacturer's part number, and quantity. We will verify this information prior to processing the order, and any discrepancies found (e.g. part numbers, pricing) will be listed in your order confirmation email.

PRICING: Catalog prices are List Prices unless otherwise noted. Net prices are based on customer discounts by product category as provided during customer onboarding. Special quotations are available for non-standard, blanket, and custom engineered product orders. Custom sizes, branding, lengths, colors, assemblies, and packaging are often available upon request. All prices are subject to change without notice.

PAYMENT TERMS: A valid credit card is required to place an order, and will be charged upon shipment, unless customer has been explicitly approved for credit. Upon validation of credit references, standard payment terms are 1.5% 15 Days, Net 30 Days. We reserve the right to revoke credit terms at any time and revert to requiring a valid credit card for shipment, particularly for frequently delinquent accounts.

SHIPPING TERMS: All shipments are FOB, Specialty Sales LLC, Lyons, IL.

ROUTING: To be specified by customer on purchase order. Otherwise, we will ship best method.

INTERNATIONAL SALES: All duties and/or applicable bank charges will be added to the order invoice or billed separately to customer.

SHIPPING CLAIMS: If a shipment is lost or damaged, please contact our customer service team within 10 days. We will work with you to file a claim with the carrier and re-ship product if required.

ORDER / SHIPPING DISCREPANCIES: Please inspect all shipments and report any shipping errors, over shipments or shortages to our customer service team within 10 days of receipt.

RETURNS: Items may not be returned without with a Return Goods Authorization (RGA) number. This RGA number must appear on your return shipping label. To be eligible for a return, your item must be unused and in its original condition. Upon receipt and inspection of returned goods, a credit will be issued to your account. Restocking charges may apply. Freight charges will be the responsibility of the customer, except in cases of shipping errors.

WARRANTY: Specialty Sales will assist our customers with any warranty claims under the manufacturer's warranty of the specific product. Specialty Sales offers no additional or supplemental warranty above and beyond the manufacturer's warranty.

OTHER CONDITIONS: Specialty Sales LLC shall not be liable in damages for, nor deemed to be in default by reason of failure or delay in shipment of all or any part of this order caused by war, fire, flood, strikes, lockouts, accident, acts of God, government order or requirement, interruption or shortage of materials or transportation facilities or other cause or circumstance, similar or otherwise, beyond its control.

**THIS PAGE IS
INTENTIONALLY
LEFT BLANK**

HOSE STYLES

PRICING CODE	DESCRIPTION	PAGE
2H	Style 5000 – Grey Pureflex Water Hose	A1
2H	Style 5015 – Clear Braided All Purpose PVC Hose – Food Grade	A2
2H	Style 5016 – Clear Braided PVC General Purpose Hose	A3
2H	Style 5220/5230 – Polyurethane/PVC Chemical Spray Hose	A4
2H	Style 5240 – 600 PSI Ribbed PVC Spray Hose - Yellow	A5
2H	Style 5260 – Natural Reinforced EVA Spray Hose	A6
1J	General Purpose Air & Water Hose – Red	A7
1J	General Purpose Air & Water Hose – Black	A8
2A	Style 8040 – Green PVC Suction / Discharge Hose	A9
2A	Style 8050 – Clear PVC Suction / Discharge Hose	A10
2A	Style 8060 – Smooth Transparent PVC Food, Beverage and Dairy Handling Suction / Discharge Hose	A11
2A	Style 8070 – Corrugated Transparent PVC Food, Beverage and Dairy Handling Suction / Discharge Hose	A12
1T	Rubber Suction Hose	A13
2X	PVC Wire Suction Hose	A14
1T	PVC Layflat Discharge Hose	A15

**THIS PAGE IS
INTENTIONALLY
LEFT BLANK**

STOP & READ BEFORE REMOVING WRAP



USE CAUTION WITH A SHARP CUTTING DEVICE

A sharp instrument can easily cut into the hose causing a spot to leak.

MOST HOSE FAILURES ARE CAUSED BY THE COUPLING

To understand how couplings cause hose failures, it is important to first understand how hose is constructed. Hose is made in layers. The first layer is a flexible tube to direct flow. The next layer(s) is yarn braid to give it strength and an outer covering for protection. If the inner tube is folded, snagged or split when a hose barb is inserted and clamps are applied too tight, leaks into the braid may occur, when pressurized.

Even a drop an hour, under pressure, will creep along the braid and raise the cover, forming blisters, which can appear anywhere along the length of the hose. Most hose failures are caused by the coupling, because reusable fittings are used or poor installation of hose barb or clamps, or the hose is abused, or pulled, yanked to the side, causing wear of the metal fitting against plastic.

The use of Hydraulic or Reusable type fittings is not recommended for coupling hose products. The sharp threads on the stem part of the reusable fittings can cut the inner tube causing the fluid under pressure to get between the two layers of the hose. This will cause the outer covering to separate (bubbling) from the inner tube, causing the hose to prematurely fail. The outer covering is designed to protect the inner tube, it is not made to direct chemical flow, nor is it chemical resistant – only the inner tube is resistant.

HELPFUL TIPS

Lubricate the hose barb with a soap and water solution (kitchen detergent is fine) and dip the hose end in as well for added lubrication. **DO NOT USE OIL OR GREASE.** They penetrate and soften the plastic.

Push the barb straight in, with a twisting motion. Rocking it back and forth can snag and tear the tube or cause it to fold inward.

Use the correct size. (Sometimes it isn't obvious). A loose barb allows a crease to form. A barb too large can split the tube.

Do not deform the hose by over-tightening clamps. They may split.

Hoses designed for pesticides are chemical resistant, not chemical proof, which means they may deteriorate over time. Hoses should always be drained and flushed before long term storage, as chemicals will pool at coil bottoms and concentrate through evaporation.

Do not pull a kink through – untwist it. Pulling it through can loosen the layers and allow the individual strands of yarn to shift into an uneven braid pattern, which can result in "BLOW OUTS" through the weak area. Twisted hose tends to kink.

Use Vinyl Guards to protect against accidental "yanking". Vinyl hose guards are plastic sheaths that slide over the fitting and cover 4 – 5" of the hose, providing support to the area of maximum stress.

**THIS PAGE IS
INTENTIONALLY
LEFT BLANK**

Style 5000 - NSF-61 Certified Grey Pureflex Water Hose

PRICING CODE

2H



FEATURES:

- Compounds used made from materials on the FDA approved list
- Clear Pureflex Tube with Dark Grey Pureflex cover
- Lightweight, Non-Marking & Flexible
- UV Resistant
- NSF Certified under Standard NSF-51 and NSF-61
- 4:1 Tested Safety Factor on Burst PSI

APPLICATIONS:

Water & Beverage Transfer Lines

TEMPERATURE RANGE:

+25°F to +150°F

BRANDING:

SPECIALTY SALES STYLE 5000 (DATE CODE) CANADA

NOTE:

Cut lengths available - 15% surcharge.

PART #	I.D.	O.D.	WORKING PRESSURE AT 68° F	WEIGHT / 100'	LENGTH
2H 5000/025	1/4"	0.445"	250 PSI	6.2 LBS	300' COIL
2H 5000/0375	3/8"	0.595"	225 PSI	9.6 LBS	300' COIL
2H 5000/050	1/2"	0.750"	200 PSI	13 LBS	300' COIL
2H 5000/075	3/4"	1.030"	150 PSI	21 LBS	300' COIL
2H 5000/075-100	3/4"	1.030"	150 PSI	21 LBS	100' COIL
2H 5000/100	1"	1.300"	125 PSI	28.7 LBS	200' COIL
2H 5000/100-100	1"	1.300"	125 PSI	28.7 LBS	100' COIL
2H 5000/125	1-1/4"	1.625"	100 PSI	52.2 LBS	100' COIL
2H 5000/150	1-1/2"	1.915"	100 PSI	60.4 LBS	100' COIL
2H 5000/200	2"	2.490"	75 PSI	86.5 LBS	100' COIL

Style 5015 – Clear Braided All Purpose PVC Hose – Food Grade

PRICING CODE

2H

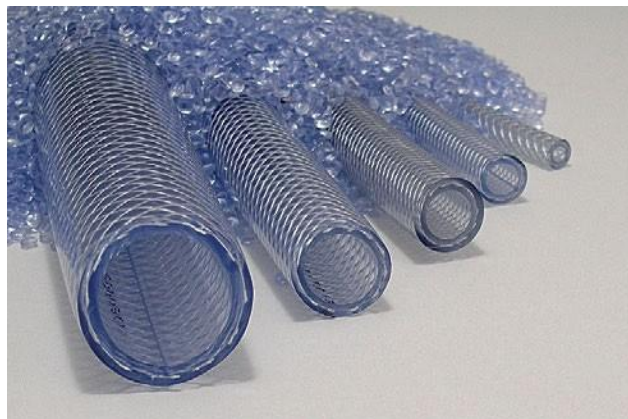

FEATURES:

- Compounds used made from materials on the FDA approved list
- Clear PVC Tube, Polyester Reinforced, Clear PVC Cover
- Lightweight, Non-Marking & Flexible
- NSF Certified under Standard NSF-61
- 4:1 Tested Safety Factor on Burst PSI

APPLICATIONS:

- Air, Water & Food Transfer
- Light Vacuum Lines
- Wire Conduit

TEMPERATURE RANGE:

+25°F to +150°F

BRANDING:

SPECIALTY SALES STYLE 5015 (DATE CODE) CANADA

NOTE:

Cut lengths available - 15% surcharge.

PART #	I.D.	O.D.	WORKING PRESSURE AT 68° F	WEIGHT / 100'	LENGTH
2H 5015/0187	3/16"	0.370"	250 PSI	4.5 LBS	300' COIL
2H 5015/025	1/4"	0.455"	250 PSI	6.5 LBS	300' COIL
2H 5015/0312	5/16"	0.515"	250 PSI	7.5 LBS	300' COIL
2H 5015/0375	3/8"	0.595"	225 PSI	9 LBS	300' COIL
2H 5015/050	1/2"	0.745"	200 PSI	14.5 LBS	300' COIL
2H 5015/050-500	1/2"	0.745"	200 PSI	14.5 LBS	500' REEL
2H 5015/0625	5/8"	0.745"	200 PSI	16.5 LBS	300' COIL
2H 5015/075	3/4"	1.020"	150 PSI	23 LBS	300' COIL
2H 5015/075-100	3/4"	1.020"	150 PSI	23 LBS	100' COIL
2H 5015/075-500	3/4"	1.020"	150 PSI	23 LBS	500' REEL
2H 5015/100	1"	1.290"	125 PSI	32 LBS	200' COIL
2H 5015/100-100	1"	1.290"	125 PSI	32 LBS	100' COIL
2H 5015/100-500	1"	1.290"	125 PSI	32 LBS	500' REEL
2H 5015/125	1-1/4"	1.625"	100 PSI	58 LBS	100' COIL
2H 5015/150	1-1/2"	1.925"	100 PSI	69 LBS	100' COIL
2H 5015/200	2"	2.480"	75 PSI	100 LBS	100' COIL

Style 5016 – Clear Braided PVC General Purpose Hose

PRICING CODE

2H

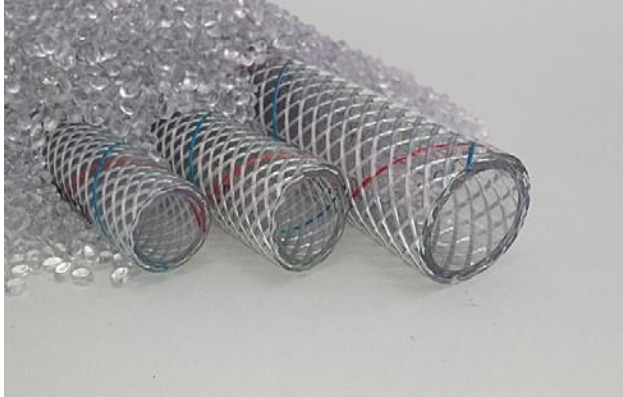

FEATURES:

- Clear PVC Tube and Cover with Polyester Reinforcement
- Lightweight and Flexible
- 80 Durometer
- Blue & Red Spiral Polyester Tracers
- 4:1 Tested Safety Factor on Burst PSI

APPLICATIONS:

- Air, Water & Light Solids Transfer
- Light Vacuum Lines
- Wire Conduit

TEMPERATURE RANGE:

+25°F to +150°F

BRANDING:

SSI STYLE 5016 (DATE CODE) CANADA

PART #	I.D.	O.D.	WORKING PRESSURE AT 68° F	WEIGHT / 100'	LENGTH
2H 5016/025	1/4"	0.418"	200 PSI	5 LBS	300' COIL
2H 5016/0375	3/8"	0.595"	200 PSI	9 LBS	300' COIL
2H 5016/0375-500	3/8"	0.595"	200 PSI	9 LBS	500' REEL
2H 5016/050	1/2"	0.720"	200 PSI	12 LBS	300' COIL
2H 5016/050-400	1/2"	0.720"	200 PSI	12 LBS	400' COIL
2H 5016/050-500	1/2"	0.720"	200 PSI	12 LBS	500' REEL
2H 5016/0625	5/8"	0.845"	175 PSI	16 LBS	300' COIL
2H 5016/075	3/4"	0.970"	200 PSI	18 LBS	300' COIL
2H 5016/100	1"	1.280"	115 PSI	22 LBS	200' COIL
2H 5016/100-100	1"	1.280"	115 PSI	22 LBS	100' COIL
2H 5016/125	1-1/4"	1.630"	110 PSI	46.5 LBS	100' COIL
2H 5016/150	1-1/2"	1.930"	110 PSI	62 LBS	100' COIL

Style 5220/5230 - Polyurethane/PVC Chemical Spray Hose

PRICING CODE

2H

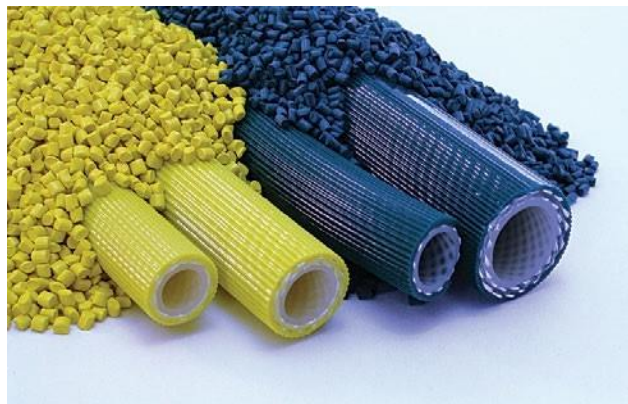
**FEATURES:**

- Polyurethane/PVC Blended Core Compound
- Lightweight, Non-Marking & Flexible
- Ribbed Jacket for Easy Coiling & Abrasion Resistance
- Resistant to Hydrocarbon Based Chemicals
- 4:1 Tested Safety Factor on Burst PSI

APPLICATIONS:

Agricultural, Nursery, Weed & Pest Control Spraying

TEMPERATURE RANGE:

+15°F to +160°F

BRANDING:

SSI STYLE 5220-5230 (DATE CODE) CANADA

STYLE 5220 - YELLOW RIBBED POLYURETHANE/PVC BLEND CHEMICAL SPRAY HOSE

PART #	I.D.	O.D.	WORKING PRESSURE AT 68° F	WEIGHT / 100'	LENGTH
2H 5220/0375	3/8"	0.655"	600 PSI	13.2 LBS	300' / 400' COIL
2H 5220/050	1/2"	0.840"	600 PSI	17.3 LBS	300' / 400' COIL
2H 5220/075	3/4"	1.140"	600 PSI	34.5 LBS	300' / 400' COIL

STYLE 5230 - BLUE RIBBED POLYURETHANE/PVC BLEND CHEMICAL SPRAY HOSE

PART #	I.D.	O.D.	WORKING PRESSURE AT 68° F	WEIGHT / 100'	LENGTH
2H 5230/0375	3/8"	0.655"	800 PSI	13.8 LBS	300' COIL
2H 5230/050	1/2"	0.840"	800 PSI	21.4 LBS	300' COIL
2H 5230/075	3/4"	1.140"	800 PSI	35.9 LBS	300' COIL

Style 5240 – 600 PSI Ribbed PVC Spray Hose – Yellow

PRICING CODE

2H



FEATURES:

- Black PVC Tube x Polyester Braid with Yellow Ribbed PVC Non-Marking and Abrasion Resistant Cover
- Reduced Weight & Improved Flexibility
- 4:1 Tested Safety Factor on Burst PSI
- Not for use with Aromatic Hydrocarbons such as Zylene

APPLICATIONS:

Weed and Lawn Spraying, Nurseries, Agricultural and Orchards

TEMPERATURE RANGE:

+25°F to +150°F

BRANDING:

SSI STYLE 5240 (DATE CODE) CANADA

PART #	I.D.	O.D.	WORKING PRESSURE AT 68° F	WEIGHT / 100'	LENGTH
2H 5240/0375	3/8"	0.635"	600 PSI	11.6 LBS	300' COIL
2H 5240/050	1/2"	0.790"	600 PSI	17 LBS	300' COIL

Style 5260 – Natural Reinforced EVA Spray Hose

PRICING CODE

2H



FEATURES:

- Excellent Service with Anhydrous Ammonia
- Good Chemical and Weather Resistance
- 4:1 Tested Safety Factor on Burst PSI

APPLICATIONS:

- Agricultural, Lawn and Chemical Transfer
- Air / Water Transfer
- Paint Fluid, Light Vacuum
- Seeder Tubing

TEMPERATURE RANGE:

-50°F to +150°F

BRANDING:

SSI STYLE 5260 (DATE CODE) CANADA

PART #	I.D.	O.D.	WORKING PRESSURE AT 68° F	WEIGHT / 100'	LENGTH
2H 5260/025	1/4"	0.500"	250 PSI	6.2 LBS	300' COIL
2H 5260/0375	3/8"	0.595"	250 PSI	7 LBS	300' COIL
2H 5260/050	1/2"	0.720"	250 PSI	9 LBS	300' COIL
2H 5260/075	3/4"	0.970"	150 PSI	13 LBS	200' COIL
2H 5260/100	1"	1.300"	150 PSI	24.5 LBS	200' COIL

Series 7092 – General Purpose Air & Water Hose – Red

PRICING CODE

1D



FEATURES:

- Black EPDM / SBR Rubber Tube
- Red EPDM / SBR Cover for Abrasion and Weathering Resistance
- Multiple Textile Spiral Reinforcement for Strength and Kink Resistance
- Tested Safety Factor on Burst PSI

APPLICATIONS:

- Air & Water Services in Industrial and Agricultural Applications
- Agricultural Chemicals
- Oil Mist Lubricating Air Lines, But Not Suitable For The Transfer Of Petroleum Products

TEMPERATURE RANGE:

-40°F to + 212°F

BRANDING:

Logo ID in. 300PSI WP GP AIR WATER - Black Ink

NOTES:

Additional 15% surcharge to List for Cut Lengths

PART #	I.D.	O.D.	WORKING PRESSURE AT 68° F	WEIGHT / 100'	LENGTH
1JGSR-04-300	1/4"	0.49"	300 PSI	10 LBS	600" REEL
1JGSR-05-300	5/16"	0.57"	300 PSI	12 LBS	600" REEL
1JGSR-06-300	3/8"	0.65"	300 PSI	17 LBS	600" REEL
1JGSR-08-300	1/2"	0.81"	300 PSI	22 LBS	600" REEL
1JGSR-10-300	5/8"	0.96"	300 PSI	30 LBS	300' REEL
1JGSR-12-300	3/4"	1.14"	300 PSI	37 LBS	300' REEL
1JGSR-16-300	1"	1.38"	300 PSI	58 LBS	300' REEL

Series 7093 – General Purpose Air & Water Hose – Black

PRICING CODE

1J



FEATURES:

- Black EPDM / SBR Rubber Tube
- Black EPDM / SBR Cover for Abrasion and Weathering Resistance
- Multiple Textile Spiral Reinforcement for Strength and Kink Resistance
- 3:1 Tested Safety Factor on Burst PSI

APPLICATIONS:

- Air & Water Services in Industrial and Agricultural Applications
- Agricultural Chemicals
- Oil Mist Lubricating Air Lines, But Not Suitable For The Transfer Of Petroleum Products

TEMPERATURE RANGE:

-14°F to +180°F

BRANDING:

Logo ID in. 300PSI WP GP AIR WATER - Yellow Ink

NOTES:

Additional 15% surcharge to List for Cut Lengths

PART #	I.D.	O.D.	WORKING PRESSURE AT 68° F	WEIGHT / 100'	LENGTH
1JGSB-04-300	1/4"	0.49"	300 PSI	10 LBS	600' REEL
1JGSB-05-300	5/16"	0.57"	300 PSI	12 LBS	600' REEL
1JGSB-06-300	3/8"	0.65"	300 PSI	17 LBS	600' REEL
1JGSB-08-300	1/2"	0.81"	300 PSI	22 LBS	600' REEL
1JGSB-10-300	5/8"	0.96"	300 PSI	30 LBS	300' REEL
1JGSB-12-300	3/4"	1.14"	300 PSI	37 LBS	300' REEL
1JGSB-16-300	1"	1.38"	300 PSI	58 LBS	300' REEL

Style 8040 – Green PVC Suction / Discharge Hose

PRICING CODE

2A



FEATURES:

- Smooth Green Cover
- Smooth Bore
- Lightweight compared to Rubber and Similar Hoses
- Resistant to Sunlight, Ozone and Damaging Industrial Atmospheres
- Suitable for Standard Coupling and Joints
- Smooth Inner Surface for Easy Flow and Easy Cleaning

APPLICATIONS:

- Water Suction & Discharge
- Irrigation, Construction, Mining & Marine Industries

TEMPERATURE RANGE:

+10°F to +140°F

NOTES:

Additional 15% surcharge to List for Cut Lengths

PART #	I.D.	O.D.	WORKING PRESSURE AT 70° F	WEIGHT / 100'	LENGTH	BEND RADIUS
2A 8040/075	3/4"	15/16"	105 PSI	20 LBS	100' COIL	3"
2A 8040/100	1"	1-1/4"	100 PSI	27 LBS	100' COIL	3"
2A 8040/125	1-1/4"	1-1/2"	95 PSI	30 LBS	100' COIL	3"
2A 8040/150	1-1/2"	1-13/16"	85 PSI	40 LBS	100' COIL	4"
2A 8040/200	2"	2-3/8"	80 PSI	60 LBS	100' COIL	5"
2A 8040/250	2-1/2"	2-7/8"	75 PSI	85 LBS	100' COIL	7"
2A 8040/300	3"	3-7/16"	65 PSI	115 LBS	100' COIL	8"
2A 8040/400	4"	4-1/2"	50 PSI	175 LBS	100' COIL	10"

Style 8050 – Clear PVC Suction / Discharge Hose

PRICING CODE

2A



FEATURES:

- Smooth Clear Cover
- Smooth Bore
- White PVC Helix
- Smooth Inner Surface for Easy Flow and Easy Cleaning

APPLICATIONS:

- Water Suction & Discharge
- Irrigation, Construction, Mining & Marine Industries

TEMPERATURE RANGE:

+10°F to +140°F

NOTES:

Additional 15% surcharge to List for Cut Lengths

PART #	I.D.	O.D.	WORKING PRESSURE AT 70° F	WEIGHT / 100'	LENGTH	BEND RADIUS
2A 8050/075	3/4"	15/16"	105 PSI	20 LBS	100' COIL	3"
2A 8050/100	1"	1-1/4"	100 PSI	27 LBS	100' COIL	3"
2A 8050/125	1-1/4"	1-1/2"	95 PSI	30 LBS	100' COIL	3"
2A 8050/150	1-1/2"	1-13/16"	85 PSI	40 LBS	100' COIL	4"
2A 8050/200	2"	2-3/8"	80 PSI	60 LBS	100' COIL	5"
2A 8050/250	2-1/2"	2-7/8"	75 PSI	85 LBS	100' COIL	7"
2A 8050/300	3"	3-7/16"	65 PSI	115 LBS	100' COIL	8"
2A 8050/400	4"	4-1/2"	50 PSI	175 LBS	100' COIL	10"

Style 8060 – Smooth Transparent PVC Food, Beverage and Dairy Handling Suction / Discharge Hose

PRICING CODE

2A

FDA



FEATURES:

- Transparent, Smooth Surface
- Made from PVC Compounds in Compliance with FDA and 3A Sanitary Standards
- Smooth Inner Surface for Easy Flow and Easy Cleaning

APPLICATIONS:

- Food Transfer
- Beverage
- Milk & Dairy Products

TEMPERATURE RANGE:

+10°F to +140°F

NOTES:

Additional 15% surcharge to List for Cut Lengths

PART #	I.D.	O.D.	WORKING PRESSURE AT 70° F	WEIGHT / 100'	LENGTH	BEND RADIUS
2A 8060/075	3/4"	15/16"	105 PSI	20 LBS	100' COIL	3"
2A 8060/100	1"	1-1/4"	100 PSI	27 LBS	100' COIL	3"
2A 8060/125	1-1/4"	1-1/2"	95 PSI	30 LBS	100' COIL	3"
2A 8060/150	1-1/2"	1-13/16"	85 PSI	40 LBS	100' COIL	4"
2A 8060/200	2"	2-3/8"	80 PSI	60 LBS	100' COIL	5"
2A 8060/250	2-1/2"	2-7/8"	75 PSI	85 LBS	100' COIL	7"
2A 8060/300	3"	3-7/16"	65 PSI	115 LBS	100' COIL	8"
2A 8060/350	3-1/2"	3-15/16"	60 PSI	135 LBS	100' COIL	9"
2A 8060/400	4"	4-1/2"	50 PSI	175 LBS	100' COIL	10"

Style 8070 – Corrugated Transparent PVC Food, Beverage and Dairy Handling Suction / Discharge Hose

PRICING CODE

2A

FDA



FEATURES:

- Corrugated Cover for Flexibility
- Made from PVC Compounds in Compliance with FDA and 3A Sanitary Standards
- USDA Approved for Meat and Poultry
- Smooth Inner Surface for Easy Flow and Easy Cleaning

APPLICATIONS:

- Food Transfer
- Beverage
- Milk & Dairy Products

TEMPERATURE RANGE:

+10°F to +140°F

NOTES:

Additional 15% surcharge to List for Cut Lengths

PART #	I.D.	O.D.	WORKING PRESSURE AT 70° F	WEIGHT / 100'	LENGTH	BEND RADIUS
2A 8070/100	1"	1-1/4"	60 PSI	27 LBS	100' COIL	2"
2A 8070/125	1-1/4"	1-1/2"	50 PSI	29 LBS	100' COIL	3"
2A 8070/150	1-1/2"	1-13/16"	50 PSI	34 LBS	100' COIL	3"
2A 8070/200	2"	2-3/8"	45 PSI	50 LBS	100' COIL	4"
2A 8070/250	2-1/2"	2-15/16"	40 PSI	77 LBS	100' COIL	6"
2A 8070/300	3"	3-7/16"	35 PSI	102 LBS	100' COIL	8"
2A 8070/400	4"	4-9/16"	35 PSI	164 LBS	100' COIL	10"

Rubber Suction Hose

PRICING CODE

1T



FEATURES:

- Smooth, Black EPDM Tube
- Synthetic Fabric Reinforcement with Double Wire Helix
- Black EPDM Cover with Fabric Impression
- Resistant to Water-Based Fertilizers & Salt Water
- Abrasion & Weather Resistant

APPLICATIONS:

- Water Suction or Discharge
- Agriculture, Irrigation, Construction, Mining

TEMPERATURE RANGE:

-25°F to +185°F

BRANDING:

Logo 4450 WATER SUCTION WP PSI (BAR)

PART #	I.D.	O.D.	WORKING PRESSURE AT 68° F	WEIGHT / 100'	LENGTH	MINIMUM BEND RADIUS
1T AQUA100-100	1"	1.380"	150 PSI	49 LBS	100' COIL	6"
1T AQUA125-100	1-1/4"	1.700"	150 PSI	75 LBS	100' COIL	6"
1T AQUA150-100	1-1/2"	1.960"	150 PSI	80 LBS	100' COIL	8"
1T AQUA200-100	2"	2.490"	150 PSI	111 LBS	100' COIL	8"
1T AQUA250-100	2-1/2"	2.990"	150 PSI	175 LBS	100' COIL	10"
1T AQUA300-100	3"	3.500"	150 PSI	224 LBS	100' COIL	12"
1T AQUA400-100	4"	4.530"	150 PSI	279 LBS	100' COIL	18"
1T AQUA600-20	6"	6.540"	150 PSI	575 LBS	20' LENGTH	31"

PVC Wire Suction Hose

PRICING CODE

2X

FEATURES:

- One Spring Wire, Clear PVC Wall
- Smooth Surface for Easy Flow and Cleaning

APPLICATIONS:

Food & Beverage

TEMPERATURE RANGE:

+20°F to +150°F

NOTES:

Sold in Standard Lengths only

PART #	I.D.	O.D.	WORKING PRESSURE AT 68° F	WEIGHT / COIL	LENGTH
2X 025POLYWIRE	1/4"	1/2"	210 PSI	9 LBS	100' COIL
2X 0375POLYWIRE	3/8"	5/8"	180 PSI	12 LBS	100' COIL
2X 050POLYWIRE	1/2"	13/16"	150 PSI	21 LBS	100' COIL
2X 0625POLYWIRE	5/8"	1"	100 PSI	32 LBS	100' COIL
2X 075POLYWIRE	3/4"	1-1/8"	100 PSI	36 LBS	100' COIL
2X 100POLYWIRE	1"	1-3/8"	84 PSI	47 LBS	100' COIL
2X 125POLYWIRE	1-1/4"	1-3/4"	84 PSI	39 LBS	50' COIL
2X 150POLYWIRE	1-1/2"	2"	84 PSI	43 LBS	50' COIL
2X 200POLYWIRE	2"	2-1/2"	70 PSI	56 LBS	50' COIL

PVC Layflat Discharge Hose

PRICING CODE

1T



FEATURES:

3-Ply Polyester Yarns Tube and Cover Extruded at the Same Time for Max Bonding

APPLICATIONS:

Mines, Construction, Irrigation, etc

TEMPERATURE RANGE:

-5°F to +170°F

NOTES:

Cuts available on 1-1/2, 2, 3, 4 with 15% cutting charge

STYLE POLYB – PVC BLUE LAYFLAT DISCHARGE HOSE

PART #	I.D.	WALL	WORKING PRESSURE AT 70° F	WEIGHT / COIL	LENGTH
1T POLYB100-300	1"	0.052"	110	31 LBS	300' COIL
1T POLYB125-300	1-1/4"	0.056"	80	42 LBS	300' COIL
1T POLYB150-300	1-1/2"	0.059"	80	56 LBS	300' COIL
1T POLYB200-300	2"	0.059"	80	73 LBS	300' COIL
1T POLYB250-300	2-1/2"	0.059"	65	90 LBS	300' COIL
1T POLYB300-300	3"	0.063"	80	108 LBS	300' COIL
1T POLYB400-300	4"	0.067"	70	158 LBS	300' COIL
1T POLYB600-300	6"	0.075"	60	259 LBS	300' COIL

PVC Layflat Discharge Hose

PRICING CODE

1T



FEATURES:

3-Ply Polyester Yarns Tube and Cover Extruded at the Same Time for Max Bonding

APPLICATIONS:

Mines, Construction, Irrigation, etc

TEMPERATURE RANGE:

-5°F to +170°F

NOTES:

Cuts available on 1-1/2, 2, 3, 4 with 15% cutting charge

STYLE POLYR – HEAVY DUTY BRICK RED PVC LAYFLAT DISCHARGE HOSE

PART #	I.D.	WALL	WORKING PRESSURE AT 70° F	WEIGHT / COIL	LENGTH
1T POLYR150-300	1-1/2"	0.079"	150	80 LBS	300' COIL
1T POLYR200-300	2"	0.087"	150	103 LBS	300' COIL
1T POLYR300-300	3"	0.095"	150	164 LBS	300' COIL
1T POLYR400-300	4"	0.102"	150	254 LBS	300' COIL
1T POLYR600-300	6"	0.119"	150	400 LBS	300' COIL
1T POLYR800-100	8"	0.134"	115	189 LBS	100' COIL

TUBING STYLES

PRICING CODE	DESCRIPTION	PAGE
2T	Style 05R – Industrial Grade Clear PVC Tubing	B1
2T	Style 05R Black – Black PVC Drain Line Tubing	B2
2T	Style 10 – Clear PVC Tubing – FDA Grade	B3
2T	Style 20 – Linear Low Density Polyethylene (LLDPE) Tubing	B4
2J	Style 20 – John Guest Linear Low Density Polyethylene (LLDPE) Tubing	B6
2T	Style 40 – Fuel Resistant PVC Tubing	B7
2T	Style 45 – Premium Grade PVC Tubing 60 Durometer	B8
2T	Style 50 – Premium Grade PVC Tubing 70 Durometer	B9
2T	Style 60 – Urethane Tubing (Ester Based)	B10
2T	Style 65 – Urethane Tubing (Ether Based)	B11
2T	Style 75 – Nylon Tubing	B12
2T-SB	SharkBite PEX Tubing	B14

**THIS PAGE IS
INTENTIONALLY
LEFT BLANK**

Style 05R – Industrial Grade Clear PVC Tubing

PRICING CODE

2T



FEATURES:

- High Quality Industrial Grade Compounds
- Durometer Range Between 65 and 80

APPLICATIONS:

- Drain Lines
- Sight Gauges
- Transfer Lines
- Light Vacuum Lines

TEMPERATURE RANGE:

+25°F to +150°F

NOTES:

- Other Sizes Available Upon Request
- May Be Slight Yellow or Blue Tint

PART #	I.D.	O.D.	WALL THICKNESS	WEIGHT / 100'	LENGTH
2T 05R-0406	1/4"	3/8"	1/16"	3.3 LBS	100' BOX
2T 05R-0408	1/4"	1/2"	1/8"	7.8 LBS	100' BOX
2T 05R-0507	5/16"	7/16"	1/16"	3.9 LBS	100' BOX
2T 05R-0608	3/8"	1/2"	1/16"	4.6 LBS	100' BOX
2T 05R-0609	3/8"	9/16"	3/32"	7.4 LBS	100' BOX
2T 05R-0609-250	3/8"	9/16"	3/32"	23.4 LBS	250' REEL
2T 05R-0610	3/8"	5/8"	1/8"	10.4 LBS	100' BOX
2T 05R-0810	1/2"	5/8"	1/16"	5.9 LBS	100' BOX
2T 05R-0811	1/2"	11/16"	3/32"	10.8 LBS	100' BOX
2T 05R-0811-250	1/2"	11/16"	3/32"	9.0 LBS	250' REEL
2T 05R-0812	1/2"	3/4"	1/8"	13.0 LBS	100' BOX
2T 05R-1014	5/8"	7/8"	1/8"	15.6 LBS	100' BOX
2T 05R-1216	3/4"	1"	1/8"	18.2 LBS	100' BOX
2T 05R-1620	1"	1-1/4"	1/8"	23.4 LBS	100' BOX

Style 05R Black – Black PVC Drain Line Tubing

PRICING CODE

2T



FEATURES:

- High Quality Industrial Grade Compounds
- Durometer Range Between 65 and 80

APPLICATIONS:

- Drain Lines
- Transfer Lines
- Light Vacuum Lines

TEMPERATURE RANGE:

+25°F to +150°F

NOTES:

Other Sizes Available Upon Request

PART #	I.D.	O.D.	WALL THICKNESS	WEIGHT / 100'	LENGTH
2T 05R-0406 BK	1/4"	3/8"	1/16"	3.3 LBS	100' BOX
2T 05R-0408 BK	1/4"	1/2"	1/8"	7.8 LBS	100' BOX
2T 05R-0609 BK	3/8"	9/16"	3/32"	7.4 LBS	100' BOX
2T 05R-0610 BK	3/8"	5/8"	1/8"	10.4 LBS	100' BOX
2T 05R-0811 BK	1/2"	11/16"	3/32"	10.8 LBS	100' BOX
2T 05R-0812 BK	1/2"	3/4"	1/8"	13.0 LBS	100' BOX
2T 05R-1014 BK	5/8"	7/8"	1/8"	15.6 LBS	100' BOX
2T 05R-1216 BK	3/4"	1"	1/8"	18.2 LBS	100' BOX
2T 05R-1620 BK	1"	1-1/4"	1/8"	23.4 LBS	100' BOX

Style 10 – Clear PVC Tubing – FDA Grade

PRICING CODE

2T



FEATURES:

- Complies with FDA CFR 21 for Food Packaging
- Resistant to a Broad range of Chemicals
- Smooth Inner Wall, Excellent Flow Characteristics
- Lightweight, Tough and Aging and Abrasion-Resistant
- Excellent Wearability
- Easy to Connect
- Clear and Flexible

APPLICATIONS:

- Food & Beverage
- Handles a Broad Range of Chemicals, Gases, and Liquids
- General-purpose chemical transfer

NOTES:

Additional sizes and wall thickness available, please call for availability

PART #	I.D.	O.D.	WALL THICKNESS	LENGTH
2T 10-0204	1/8"	1/4"	1/16"	100' BOX
2T 10-0305	3/16"	5/16"	1/16"	100' BOX
2T 10-0406	1/4"	3/8"	1/16"	100' BOX
2T 10-0408	1/4"	1/2"	1/8"	100' BOX
2T 10-0507	5/16"	7/16"	1/16"	100' BOX
2T 10-0508	5/16"	1/2"	3/32"	100' BOX
2T 10-0509	5/16"	9/16"	1/8"	100' BOX
2T 10-0608	3/8"	1/2"	1/16"	100' BOX
2T 10-0609	3/8"	9/16"	3/32"	100' BOX
2T 10-0610	3/8"	5/8"	1/8"	100' BOX
2T 10-0810	1/2"	5/8"	1/16"	100' BOX
2T 10-0812	1/2"	3/4"	1/8"	100' BOX
2T 10-1012	5/8"	3/4"	1/16"	100' BOX
2T 10-1014	5/8"	7/8"	1/8"	100' BOX
2T 10-1214	3/4"	7/8"	1/16"	100' BOX
2T 10-1216	3/4"	1"	1/8"	100' BOX
2T 10-1620	1"	1-1/4"	1/8"	100' BOX
2T 10-2024	1-1/4"	1-1/2"	1/8"	50' BOX
2T 10-2028	1-1/4"	1-3/4"	1/4"	50' BOX
2T 10-2432	1-1/2"	2"	1/4"	50' BOX
2T 10-3240	2"	2-1/2"	1/4"	50' BOX

Style 20 – Linear Low Density Polyethylene (LLDPE) Tubing

PRICING CODE

2T



FEATURES:

- Made From Non-Toxic Ingredients Conforming to FDA Standards
- Superior Crack Resistance
- Higher Working Pressure than Conventional Low Density Polyethylene
- Flexible, Lightweight and Durable
- Odorless and Tasteless
- Good Dielectric Properties
- Better Resistance to Stress Cracking than Low Density Polyethylene
- Chemically Inert

APPLICATIONS:

- Air, Water, and Chemical Transfer
- Transportation of Gases, Vapors, and Moisture

TEMPERATURE RANGE:

-50°F to +140°F

How To Order:

2T	20	0403	BK	500
PRODUCT CODE	STYLE	TUBE O.D. SIZE	COLOR	LENGTH
2T	20 – LLDPE	0402 – 1/4" O.D. 0403 – 1/4" O.D. 0503 – 5/16" O.D. 0604 – 3/8" O.D. 0806 – 1/2" O.D. 1008 – 5/8" O.D. 1210 – 3/4" O.D. 1612 – 1" O.D.	BK – Black N – Natural BU – Blue RD – Red GN – Green GY – Gray OR – Orange WH – White YW – Yellow	100' 250' 500' 1000'

PART #	O.D.	I.D.	WALL THICKNESS	WORKING PRESSURE AT 73°F	LENGTH
2T 20-0402	1/4"	0.125"	0.062"	180 PSI	100' COIL
2T 20-0402	1/4"	0.125"	0.062"	180 PSI	500' REEL
2T 20-0402	1/4"	0.125"	0.062"	180 PSI	1,000' REEL
2T 20-0403	1/4"	0.170"	0.040"	135 PSI	100' COIL
2T 20-0403	1/4"	0.170"	0.040"	135 PSI	500' REEL

* Call for special pricing and availability

Continued on next page...

Style 20 – Linear Low Density Polyethylene (LLDPE) Tubing

PRICING CODE

2T



PART #	O.D.	I.D.	WALL THICKNESS	WORKING PRESSURE AT 73°F	LENGTH
2T 20-0403	1/4"	0.170"	0.040"	135 PSI	1,000' REEL
2T 20-0503	5/16"	0.187"	0.062"	103 PSI	100' COIL
2T 20-0503	5/16"	0.187"	0.062"	103 PSI	500' REEL
2T 20-0503	5/16"	0.187"	0.062"	103 PSI	1,000' REEL
2T 20-0604	3/8"	0.250"	0.062"	120 PSI	100' COIL
2T 20-0604	3/8"	0.250"	0.062"	120 PSI	500' REEL
2T 20-0604	3/8"	0.250"	0.062"	120 PSI	1,000' REEL
2T 20-0806	1/2"	0.375"	0.062"	90 PSI	100' COIL
2T 20-0806	1/2"	0.375"	0.062"	90 PSI	500' REEL
2T 20-1008	5/8"	0.500"	0.062"	70 PSI	100' COIL
2T 20-1008	5/8"	0.500"	0.062"	70 PSI	250' REEL
2T 20-1210	3/4"	0.625"	0.062"	50 PSI	100' COIL
2T 20-1612	1"	0.750"	0.125"	90 PSI	100' COIL

* Call for special pricing and availability

** Available in Natural & Black only



Style 20 – Linear Low Density Polyethylene (LLDPE) Tubing

PRICING CODE 2J



FEATURES:

- Wide Range Temperature and Pressure Suitability
- Broad Chemical Compatibility
- Made from Non-Contaminating Materials
- Variety Colors
- Made from FDA Approved Materials
- NSF International Certified
- Chemical Resistance, for Use with Chemicals or Potentially Aggressive Liquids

APPLICATIONS:

- Water Purifications and Conditioners
- Icemakers
- Misting Systems

NOTES:

- Please Ensure Compatibility when Using Cleaning Agents or Other Potentially Aggressive Liquids
- Metric Sizes Available, Please Call.

How To Order:

2T	20	0403	BK	500	J
PRODUCT CODE	STYLE	TUBE O.D. SIZE	COLOR	LENGTH	JOHN GUEST
2T	20 – LLDPE	0403 – 1/4" O.D. 0503 – 5/16" O.D. 0604 – 3/8" O.D. 0806 – 1/2" O.D.	BK – Black N – Natural BU – Blue RD – Red WH – White GN – Green OR – Orange V – Violet YW – Yellow	250' 500' 1000' <i>* Call for additional lengths.</i>	

PART #	I.D.	O.D.	WORKING PRESSURE AT 70°F	WORKING PRESSURE AT 150°F	LENGTH
2T 20-0403N-500J	0.170"	1/4"	230 PSI	120 PSI	500' REEL
2T 20-0403N-1000J	0.170"	1/4"	230 PSI	120 PSI	1,000' REEL
2T 20-0503N-500J	0.187"	5/16"	230 PSI	120 PSI	500' REEL
2T 20-0604N-500J	0.250"	3/8"	230 PSI	120 PSI	500' REEL
2T 20-0806N-250J	0.375"	1/2"	150 PSI	90 PSI	250' REEL

Style 40 – Fuel Resistant PVC Tubing

PRICING CODE

2T



FEATURES:

- Resists Swelling and Hardening when Exposed to Gasoline, Heating Oils, Cutting Compounds and Glycol-based Coolants
- Transparent Yellow for Easy Identification
- Flexible 65 Durometer (Shore A) Compound
- Similar to TYGON® Formulation F-4040-A

APPLICATIONS:

- Fuel Vent Tubes, Drain Lines, and Overflow Tubes
- Transfer of Gasoline, Heating Oils, Cutting Compounds and Coolants
- For Intermittent Use with Petroleum-based Products
- Lab Handling of Distillates
- NOT intended for use with Foods or Beverages

PART #	I.D.	O.D.	WALL THICKNESS	LENGTH
2T 40-0204	1/8"	1/4"	1/16"	100' BOX
2T 40-0305	3/16"	5/16"	1/16"	100' BOX
2T 40-0406	1/4"	3/8"	1/16"	100' BOX
2T 40-0507	5/16"	7/16"	1/16"	100' BOX
2T 40-0608	3/8"	1/2"	1/16"	100' BOX
2T 40-0710	7/16"	5/8"	3/32"	100' BOX
2T 40-0812	1/2"	3/4"	1/8"	100' BOX
2T 40-1014	5/8"	7/8"	1/8"	100' BOX
2T 40-1216	3/4"	1"	1/8"	50' BOX

Style 45 – Premium Grade PVC Tubing 60 Durometer

PRICING CODE

2T



FEATURES:

- Complies to USP Class VI
- Complies to USDA Standards
- Complies to FDA CFR 21 for Food Packaging
- Autoclavable
- Smooth Inner Walls Resist Build-up
- Flexible 60 Durometer
- Comparable To TYGON® B-44-3/ B-44-4X/ S-50-HI (*TYGON-Registered Trademark Of Saint-Gobain Performance Plastics)

APPLICATIONS:

- Lab and Research
- Food/Beverage Processing
- Peristaltic Pumps
- Media Manufacture/Transfer
- Vapor Transfer

TEMPERATURE RANGE:

-25°F to +160°F

PART #	I.D.	O.D.	WALL THICKNESS	WORKING PRESSURE AT 73°F	LENGTH
2T 45-0102	1/16"	1/8"	1/32"	48 PSI	100' BOX
2T 45-0204	1/8"	1/4"	1/16"	50 PSI	100' BOX
2T 45-0305	3/16"	5/16"	1/16"	36 PSI	100' BOX
2T 45-0406	1/4"	3/8"	1/16"	30 PSI	100' BOX
2T 45-0407	1/4"	7/16"	3/32"	40 PSI	100' BOX
2T 45-0408	1/4"	1/2"	1/8"	46 PSI	100' BOX
2T 45-0507	5/16"	7/16"	1/16"	28 PSI	100' BOX
2T 45-0608	3/8"	1/2"	1/16"	22 PSI	100' BOX
2T 45-0609	3/8"	9/16"	3/32"	32 PSI	100' BOX
2T 45-0610	3/8"	5/8"	1/8"	40 PSI	100' BOX
2T 45-0810	1/2"	5/8"	1/16"	20 PSI	100' BOX
2T 45-0812	1/2"	3/4"	1/8"	30 PSI	100' BOX
2T 45-1014	5/8"	7/8"	1/8"	26 PSI	100' BOX
2T 45-1216	3/4"	1"	1/8"	22 PSI	50' BOX
2T 45-1620	1"	1-1/4"	1/8"	18 PSI	50' BOX
2T 45-2026	1-1/4"	1-5/8"	3/16"	22 PSI	50' BOX
2T 45-2432	1-1/2"	2"	1/4"	24 PSI	50' BOX

Style 50 – Premium Grade PVC Tubing 70 Durometer

PRICING CODE

2T



FEATURES:

- Complies to NSF-51, 3A
- Complies to USP Class VI
- Complies to FDA CFR 21 for Food Packaging
- Complies to USDA Standards
- Will Not Impart Taste or Odor
- Resistant to Alkaline Cleaners and Sanitizers
- Flexible 70 Durometer
- Comparable To TYGON® B-44-3/ B-44-4X/ S-50-HI (*TYGON-Registered Trademark Of Saint-Gobain Performance Plastics)

APPLICATIONS:

- Transfer of Foods, Beverages, Syrups, Cooking Oils, Flavor Extracts, and Preservatives
- Transfer of Milk and Dairy Products
- Dialysis
- Blood Transfer
- Drainage Lines
- Irrigation Lines

TEMPERATURE RANGE:

-10°F to +175°F

PART #	I.D.	O.D.	WALL THICKNESS	WORKING PRESSURE AT 73°F	LENGTH
2T 50-0305	3/16"	5/16"	1/16"	54 PSI	100' BOX
2T 50-0406	1/4"	3/8"	1/16"	46 PSI	100' BOX
2T 50-0408	1/4"	1/2"	1/8"	70 PSI	100' BOX
2T 50-0507	5/16"	7/16"	1/16"	40 PSI	100' BOX
2T 50-0608	3/8"	1/2"	1/16"	34 PSI	100' BOX
2T 50-0610	3/8"	5/8"	1/8"	58 PSI	100' BOX
2T 50-0810	1/2"	5/8"	1/16"	28 PSI	100' BOX
2T 50-0812	1/2"	3/4"	1/8"	44 PSI	100' BOX
2T 50-1014	5/8"	7/8"	1/8"	38 PSI	100' BOX
2T 50-1216	3/4"	1"	1/8"	34 PSI	50' BOX
2T 50-1620	1"	1-1/4"	1/8"	28 PSI	50' BOX
2T 50-2432	1-1/2"	2"	1/4"	36 PSI	50' BOX

Style 60 – Urethane Tubing (Ester Based)

PRICING CODE

2T



FEATURES:

- Ester Based 85 Durometer
- High Tensile Strength
- Excellent Abrasion Resistance
- Extremely Flexible
- Not Recommended for Aqueous Solutions
- Complies with FDA CFR 21 for Food Packaging

APPLICATIONS:

- Fuel Lines
- High Purity Applications
- Instrumentation
- Petroleum Transfer
- Gas Sampling

TEMPERATURE RANGE:

-70°F to + 175°F

PART #	I.D.	O.D.	WALL THICKNESS	WORKING PRESSURE AT 73°F	LENGTH
2T 60-0102	1/16"	1/8"	1/32"	106 PSI	100' BOX
2T 60-0203	1/8"	3/16"	1/32"	70 PSI	100' BOX
2T 60-0204	1/8"	1/4"	1/16"	110 PSI	100' BOX
2T 60-0304	3/16"	1/4"	1/32"	56 PSI	100' BOX
2T 60-0305	3/16"	5/16"	1/16"	86 PSI	100' BOX
2T 60-0405	1/4"	5/16"	1/32"	50 PSI	100' BOX
2T 60-0406	1/4"	3/8"	1/16"	76 PSI	100' BOX
2T 60-0407	1/4"	7/16"	3/32"	96 PSI	100' BOX
2T 60-0408	1/4"	1/2"	1/8"	110 PSI	100' BOX
2T 60-0507	5/16"	7/16"	1/16"	66 PSI	100' BOX
2T 60-0509	5/16"	9/16"	1/8"	100 PSI	100' BOX
2T 60-0608	3/8"	1/2"	1/16"	56 PSI	100' BOX
2T 60-0609	3/8"	9/16"	3/32"	76 PSI	100' BOX
2T 60-0610	3/8"	5/8"	1/8"	90 PSI	100' BOX
2T 60-0710	7/16"	5/8"	3/32"	66 PSI	100' BOX
2T 60-0810	1/2"	5/8"	1/16"	40 PSI	100' BOX
2T 60-0812	1/2"	3/4"	1/8"	76 PSI	100' BOX
2T 60-1013	5/8"	13/16"	3/32"	52 PSI	100' BOX
2T 60-1014	5/8"	7/8"	1/8"	60 PSI	100' BOX
2T 60-1216	3/4"	1"	1/8"	56 PSI	50' BOX
2T 60-1418	7/8"	1-1/8"	1/8"	46 PSI	50' BOX
2T 60-1620	1"	1-1/4"	1/8"	40 PSI	50' BOX

Style 65 – Urethane Tubing (Ether Based)

PRICING CODE

2T



FEATURES:

- Ether Based 84 Durometer
- Excellent for Fluid Power and All Areas where Moisture is Present
- Superior Resistance to Hydrolytic Degradation
- High Impact, Abrasion and Tearing Resistance
- Very Flexible and Kink Resistance
- Complies with FDA CFR 21 for Food Packaging
- Pure Polyurethane, Contains No Plasticizers and Low Levels of Extractables
- Clear and Flexible

APPLICATIONS:

- High-purity Applications
- Instrumentation
- Distilled, Deionized, Demineralized or Reverse Osmosis Treated Water
- Handles Petroleum-base Products
- Recommended for Use with Aqueous Solutions

PART #	I.D.	O.D.	WALL THICKNESS	WORKING PRESSURE AT 73°F	LENGTH
2T 65-0102	1/16"	1/8"	1/32"	90 PSI	100' BOX
2T 65-0203	1/8"	3/16"	1/32"	58 PSI	100' BOX
2T 65-0204	1/8"	1/4"	1/16"	92 PSI	100' BOX
2T 65-0304	3/16"	1/4"	1/32"	48 PSI	100' BOX
2T 65-0305	3/16"	5/16"	1/16"	72 PSI	100' BOX
2T 65-0405	1/4"	5/16"	1/32"	42 PSI	100' BOX
2T 65-0406	1/4"	3/8"	1/16"	64 PSI	100' BOX
2T 65-0407	1/4"	7/16"	3/32"	80 PSI	100' BOX
2T 65-0408	1/4"	1/2"	1/8"	92 PSI	100' BOX
2T 65-0507	5/16"	7/16"	1/16"	56 PSI	100' BOX
2T 65-0509	5/16"	9/16"	1/8"	84 PSI	100' BOX
2T 65-0608	3/8"	1/2"	1/16"	48 PSI	100' BOX
2T 65-0609	3/8"	9/16"	3/32"	64 PSI	100' BOX
2T 65-0610	3/8"	5/8"	1/8"	76 PSI	100' BOX
2T 65-0710	7/16"	5/8"	3/32"	56 PSI	100' BOX
2T 65-0810	1/2"	5/8"	1/16"	34 PSI	100' BOX
2T 65-0812	1/2"	3/4"	1/8"	64 PSI	100' BOX
2T 65-1013	5/8"	13/16"	3/32"	44 PSI	100' BOX
2T 65-1014	5/8"	7/8"	1/8"	50 PSI	100' BOX
2T 65-1216	3/4"	1"	1/8"	48 PSI	50' BOX
2T 65-1418	7/8"	1-1/8"	1/8"	38 PSI	50' BOX
2T 65-1620	1"	1-1/4"	1/8"	34 PSI	50' BOX

Style 75 – Nylon Tubing

PRICING CODE

2T



FEATURES:

- Excellent Resistance to a Wide Range of Chemicals Including Oils, Gasoline, Hydraulic Fluids, Salt Solutions, and Bases
- Very Low Moisture Absorption, Good Mechanical Properties, and Excellent Electrical Properties

APPLICATIONS:

- Air and Lubrication Lines
- Low Pressure Hydraulic Lines
- Instrumentation
- Process Lines for Chemicals and Solvents

TEMPERATURE RANGE:

-40°F to 225°F

NOTES:

- Available in Natural, Black, Red, Green, Blue, Yellow, and Orange
- Check for Minimum Runs of Other than Natural and Black

How To Order:

2T	75	04	BK	500
PRODUCT CODE	STYLE	TUBE O.D. SIZE	COLOR	LENGTH
2T	75 - Nylon	02 - 1/8"	BK - Black	100'
		025 - 5/32"	N - Natural	500'
		03 - 3/16"	BU - Blue	1000'
		04 - 1/4"	RD - Red	
		05 - 5/16"	GN - Green	
		06 - 3/8"	OR - Orange	
		08 - 1/2"	YW - Yellow	

PART #	O.D.	I.D.	WALL THICKNESS	LENGTH
2T75-02	1/8"	0.091"	0.017"	100' COIL
2T75-02	1/8"	0.091"	0.017"	500' REEL
2T75-02	1/8"	0.091"	0.017"	1,000' REEL
2T75-025	5/32"	0.106"	0.025"	100' COIL
2T75-025	5/32"	0.106"	0.025"	500' REEL
2T75-025	5/32"	0.106"	0.025"	1,000' REEL

Continued on next page...

Style 75 – Nylon Tubing

PRICING CODE

2T



PART #	O.D.	I.D.	WALL THICKNESS	LENGTH
2T75-03	3/16"	0.139"	0.024"	100' COIL
2T75-03	3/16"	0.139"	0.024"	500' REEL
2T75-03	3/16"	0.139"	0.024"	1,000' REEL
2T75-04	1/4"	0.180"	0.035"	100' COIL
2T75-04	1/4"	0.180"	0.035"	500' REEL
2T75-04	1/4"	0.180"	0.035"	1,000' REEL
2T75-05	5/16"	0.232"	0.040"	100' COIL
2T75-05	5/16"	0.232"	0.040"	500' REEL
2T75-05	5/16"	0.232"	0.040"	1,000' REEL
2T75-06	3/8"	0.275"	0.050"	100' COIL
2T75-06	3/8"	0.275"	0.050"	500' REEL
2T75-06	3/8"	0.275"	0.050"	1,000' REEL
2T75-08	1/2"	0.376"	0.062"	100' COIL
2T75-08	1/2"	0.376"	0.062"	500' REEL



SharkBite® Potable Water Pex Pipe

PRICING CODE **2T-SB**



FEATURES:

- Approved for Use in Both Hot and Cold Plumbing Installations
- Meets the Highest Chlorine Resistance Standards
- Utilizes the Most Energy Efficient Manufacturing Process
- ASTM PEX Standards Certified
- Can Bend Up to Six times the Outside Diameter of the Pipe (The Highest Standard)

APPLICATIONS:

- Domestic Plumbing
- Fire Suppression Systems (Residential Fire Sprinklers)
- Municipal Water Service Pipe for use in Underground Applications
- Radiant Heating Systems for Suspended Floor Systems or in Slab Construction
- Snow and Ice Melt Systems for Sidewalks, Driveways, Entrances, and Ramps
- Turf Conditioning for Greenhouses, Golf Courses, and Sports Fields
- Water Reuse and Reclamations Systems

NOTES:

Available in White, Red, Blue

PART #	I.D.	LENGTH
2T SB025W-50	1/4"	50' COIL
2T SB025W-100	1/4"	100' COIL
2T SB038W-50	3/8"	50' COIL
2T SB038W-100	3/8"	100' COIL
2T SB050W-25	1/2"	25' COIL
2T SB050W-50	1/2"	50' COIL
2T SB050W-100	1/2"	100' COIL
2T SB050W-300	1/2"	300' COIL
2T SB050W-500	1/2"	500' COIL
2T SB050W-1000	1/2"	1,000' COIL
2T SB075W-25	3/4"	25' COIL
2T SB075W-50	3/4"	50' COIL
2T SB075W-100	3/4"	100' COIL
2T SB075W-300	3/4"	300' COIL
2T SB075W-500	3/4"	500' COIL
2T SB100W-100	1"	100' COIL
2T SB100W-300	1"	300' COIL
2T SB100W-500	1"	500' COIL

* Part Numbers above are for White color.
 Substitute "W" above with "R" for Red or "B" for Blue.

COUPLINGS STYLES

PRICING CODE	DESCRIPTION	PAGE
4Z	Cam-Operated Couplers and Adapters	C1
4G	Cam-Operated Coupling Gaskets & Shims	C12
3A	Metal Cam-Operated Couplers and Adapters	C13
3A	"Air King" Universal Coupling – Air Service Only	C18

**THIS PAGE IS
INTENTIONALLY
LEFT BLANK**

COUPLINGS MATERIALS

Our line of cam-operating couplings allow for quick connections and disconnections in the field. These couplings are offered in materials below, each with different chemical resistance, temperature and other technical specifications for various applications. Please reach out for a full chemical resistance table and any other technical information you may need. We also offer a line of replacement gaskets in various materials, along with shims. Note: Please ensure couplings are opened and closed using both handles at the same time for best results.

NYLON

- Safety latches available on all couplers and dust caps ranging in size from 1¼" to 4"
- Lightweight, ½ the weight of aluminum
- Strong, resists cross threading, thread seizure and "out-of-round" condition
- Chemical resistant to most acids (please contact us for a full chemical resistance table)
- Non-conducting
- All couplers feature stainless steel handles and pins, blue nylon handles available
- Interchangeable with other couplers and adapters manufactured to MIL-spec
- EPDM gaskets furnished standard. Buna-N, Viton® and Nitrile also available
- Temperature range under normal conditions -30°F to 200°F

POLYPROPYLENE

- Safety latches available on all couplers and dust caps ranging in size from 1¼" to 4"
- Chemical resistant to most acids (please contact us for a full chemical resistance table)
- Temperature range from 10°F to 180°F
- All couplers feature stainless steel handles and pins
- Interchangeable with other couplers and adapters manufactured to MIL-spec
- EPDM gaskets furnished standard. Buna-N, Viton® and Nitrile also available

FOOD GRADE GLASS-FILLED POLYPROPYLENE



- Chemically resistant to most acids (please contact us for a full chemical resistance table)
- FDA / NSF compliant
- All couplers feature stainless steel handles and pins
- Interchangeable with other couplers and adapters manufactured to MIL-spec
- Nitrile gaskets furnished as standard. EPDM, Buna-N and Viton® also available
- Good mechanical strength
- Resistance to alkalis, salts and alcohols
- Resistance to animal, vegetable and mineral oils
- Resistance to phosphoric and hydrochloric acids
- Temperature range under normal conditions from 10°F to 180°F

PVC

- Use with PVC pipe
- Easy to install
- Socket solvent weld (cement)
- Stainless steel handles, rings and pins
- EPDM gaskets standard
- Economical
- Weather & corrosion resistant

POLYVINYLIDENE FLUORIDE (PVDF)



- Chemically resistant to most acids (please contact us for a full chemical resistance table)
- Interchangeable with other couplers and adapters manufactured to MIL-spec
- EPDM gaskets furnished as standard. Buna-N, Viton® and Nitrile also available
- All couplers feature stainless steel handles and pins
- Nonflammable and self-extinguishing
- UV stable in the visible spectrum
- NSF compliant
- Temperature range under normal conditions -20°F to 300°F



**THIS PAGE IS
INTENTIONALLY
LEFT BLANK**

Cam-Operated Couplers and Adapters

PRICING CODE

4Z

PART A – ADAPTER X FEMALE NPT





	SIZE	NY-GLASS	POLY-GLASS	ALL CHEM PVDF	PVC	FOOD-FLO
	1/4"	4Z CNA025	4Z CPA025	-	-	-
	3/8"	4Z CNA038	4Z CPA038	-	-	-
	1/2"	4Z CNA050	4Z CPA050	4Z CVA050	4Z CSA050	-
	3/4"	4Z CNA075	4Z CPA075	4Z CVA075	4Z CSA075	4Z CFA075
	1"	4Z CNA100	4Z CPA100	4Z CVA100	4Z CSA100	4Z CFA100
	1-1/2" x 1-1/4"	4Z CNA125	4Z CPA125	-	4Z CSA125	-
	1-1/2"	4Z CNA150	4Z CPA150	4Z CVA150	4Z CSA150	4Z CFA150
	2"	4Z CNA200	4Z CPA200	4Z CVA200	4Z CSA200	4Z CFA200
	3"	4Z CNA300	4Z CPA300	4Z CVA300	4Z CSA300	4Z CFA300
	4"	4Z CNA400	4Z CPA400	-	-	-

Cam-Operated Couplers and Adapters

PRICING CODE

4Z

PART B – COUPLER X MALE NPT W/ STAINLESS STEEL HANDLES

	SIZE	NY-GLASS	POLY-GLASS	ALL CHEM PVDF	FOOD-FLO
	1/2"	4Z CNB050S	4Z CPB050S	4Z CVB050S	-
	3/4"	4Z CNB075S	4Z CPB075S	4Z CVB075S	4Z CFB075S
	1"	4Z CNB100S	4Z CPB100S	4Z CVB100S	4Z CFB100S
	1-1/2" x 1-1/4"	4Z CNB125S	4Z CPB125S	-	-
	1-1/2"	4Z CNB150S	4Z CPB150S	4Z CVB150S	4Z CFB150S
	2"	4Z CNB200S	4Z CPB200S	4Z CVB200S	4Z CFB200S
	3"	4Z CNB300	4Z CPB300	4Z CVB300	4Z CFB300S
	4"	4Z CNB400	4Z CPB400	-	-

Cam-Operated Couplers and Adapters

PRICING CODE

4Z

PART C – COUPLER X HOSE SHANK W/ STAINLESS STEEL HANDLES



	SIZE	NY-GLASS	POLY-GLASS	ALL CHEM PVDF	FOOD-FLO
	1/2"	4Z CNC050S	4Z CPC050S	4Z CVC050S	-
	5/8"	4Z CNC058S	-	-	-
	3/4"	4Z CNC075S	4Z CPC075S	4Z CVC075S	4Z CFC075S
	1"	4Z CNC100S	4Z CPC100S	4Z CVC100S	4Z CFC100S
	1-1/2" x 1-1/4"	4Z CNC125S	4Z CPC125S	-	-
	1-1/2"	4Z CNC150S	4Z CPC150S	4Z CVC150S	4Z CFC150S
	2"	4Z CNC200S	4Z CPC200S	4Z CVC200S	4Z CFC200S
	3"	4Z CNC300	4Z CPC300	4Z CVC300	4Z CFC300S
	4"	4Z CNC400	4Z CPC400	-	-

Cam-Operated Couplers and Adapters

PRICING CODE

4Z

PART D – COUPLER X FEMALE NPT W/ STAINLESS STEEL HANDLES

	SIZE	NY-GLASS	POLY-GLASS	ALL CHEM PVDF	PVC	FOOD-FLO
	1/4"	4Z CND025S	-	-	-	-
	3/8"	4Z CND038S	4Z CPD038S	-	-	-
	1/2"	4Z CND050S	4Z CPD050S	4Z CVD050S	4Z CSD050S	-
	3/4"	4Z CND075S	4Z CPD075S	4Z CVD075S	4Z CSD075S	4Z CFD075S
	3/4" X 1"	4Z CND1075	-	-	-	-
	1"	4Z CND100S	4Z CPD100S	4Z CVD100S	4Z CSD100S	4Z CFD100S
	1-1/2" x 1-1/4"	4Z CND125S	4Z CPD125S	-	4Z CSD125S	-
	1-1/2"	4Z CND150S	4Z CPD150S	4Z CVD150S	4Z CSD150S	4Z CFD150S
	2"	4Z CND200S	4Z CPD200S	4Z CVD200S	4Z CSD200S	4Z CFD200S
	3"	4Z CND300	4Z CPD300	4Z CVD300	4Z CSD300S	4Z CFD300S
	4"	4Z CND400	4Z CPD400	-	-	-

Cam-Operated Couplers and Adapters

PRICING CODE

4Z

PART E – ADAPTER X HOSE SHANK



	SIZE	NY-GLASS	POLY-GLASS	ALL CHEM PVDF	FOOD-FLO
	1/2"	4Z CNE050	4Z CPE050	4Z CVE050	-
	5/8"	4Z CNE058	-	-	-
	3/4"	4Z CNE075	4Z CPE075	4Z CVE075	4Z CFE075
	1"	4Z CNE100	4Z CPE100	4Z CVE100	4Z CFE100
	1-1/2" x 1-1/4"	4Z CNE125	4Z CPE125	-	-
	1-1/2"	4Z CNE150	4Z CPE150	4Z CVE150	4Z CFE150
	2"	4Z CNE200	4Z CPE200	4Z CVE200	4Z CFE200
	3"	4Z CNE300	4Z CPE300	4Z CVE300	4Z CFE300
	4"	4Z CNE400	4Z CPE400	-	-

Cam-Operated Couplers and Adapters

PRICING CODE

4Z

PART F – ADAPTER X MALE NPT



	SIZE	NY-GLASS	POLY-GLASS	ALL CHEM PVDF	FOOD-FLO
	1/2"	4Z CNF050	4Z CPF050	4Z CVF050	-
	3/4"	4Z CNF075	4Z CPF075	4Z CVF075	4Z CFF075
	1"	4Z CNF100	4Z CPF100	4Z CVF100	4Z CFF100
	1-1/2" x 1-1/4"	4Z CNF125	4Z CPF125	-	-
	1-1/2"	4Z CNF150	4Z CPF150	4Z CVF150	4Z CFF150
	2"	4Z CNF200	4Z CPF200	4Z CVF200	4Z CFF200
	3"	4Z CNF300	4Z CPF300	4Z CVF300	4Z CFF300
	4"	4Z CNF400	4Z CPF400	-	-

Cam-Operated Couplers and Adapters

PRICING CODE | 4Z

PART DP – ADAPTER DUST PLUG



	SIZE	NY-GLASS	POLY-GLASS	ALL CHEM PVDF	FOOD-FLO
	3/4"	4Z CNZDP075	4Z CPZDP075	4Z CVZDP075	4Z CFZDP075
	1"	4Z CNZDP100	4Z CPZDP100	4Z CVZDP100	4Z CFZDP100
	1-1/2"	4Z CNZDP150	4Z CPZDP150	4Z CVZDP150	4Z CFZDP150
	2"	4Z CNZDP200	4Z CPZDP200	4Z CVZDP200	4Z CFZDP200
	3"	4Z CNZDP300	4Z CPZDP300	4Z CVZDP300	4Z CFZDP300
	4"	4Z CNZDP400	4Z CPZDP400	-	-

Cam-Operated Couplers and Adapters

PRICING CODE | 4Z

PART DC – COUPLER DUST CAP S/S HANDLES



SIZE	NY-GLASS	POLY-GLASS	ALL CHEM PVDF	FOOD-FLO
3/4"	4Z CNZDC075S	4Z CPZDC075S	4Z CVZDC075S	4Z CFZDC075S
1"	4Z CNZDC100S	4Z CPZDC100S	4Z CVZDC100S	4Z CFZDC100S
1-1/2"	4Z CNZDC150S	4Z CPZDC150S	4Z CVZDC150S	4Z CFZDC150S
2"	4Z CNZDC200S	4Z CPZDC200S	4Z CVZDC200S	4Z CFZDC200S
3"	4Z CNZDC300	4Z CPZDC300	4Z CVZDC300	4Z CFZDC300S
4"	4Z CNZDC400	4Z CPZDC400	-	-

COUPLING ACCESSORIES HANDLE ASSEMBLY PARTS



SIZE	GROOVE PIN	S/S HANDLES	SAFETY LOCK
3/4" - 1"	4Z MSGPS	4Z MSHS	4Z MSLPS
1-1/4" - 2"	4Z MSGPM	4Z MSHM	4Z MSLPL
3" - 4"	4Z MSGPL	4Z MSHL	-

Cam-Operated Couplers and Adapters

PRICING CODE 4Z

HOSE NIPPLES



SIZE	NY-GLASS	POLY-GLASS	FOOD-FLO	PVDF
1/2"	4Z HNHN050	4Z HPHN050	4Z HFHN050	4Z CVHN050
3/4"	4Z HNHN075	4Z HPHN075	4Z HFHN075	4Z CVHN075
1"	4Z HNHN100	4Z HPHN100	4Z HFHN100	4Z CVHN100
1-1/4"	4Z HNHN125	4Z HPHN125	4Z HFHN125	4Z CVHN125
1-1/2"	4Z HNHN150	4Z HPHN150	4Z HFHN150	4Z CVHN150
2"	4Z HNHN200	4Z HPHN200	4Z HFHN200	4Z CVHN200
3"	4Z HNHN300	4Z HPHN300	4Z HFHN300	4Z CVHN300
4"	4Z HNHN400	4Z HPHN400	-	-

Cam-Operated Couplers and Adapters

PRICING CODE | 4Z

PURE WATER TANK CAPS TYPE 100 3-WAY 2-1/2" TANK THREAD



SIZE	NY-GLASS	POLY-GLASS	2-1/2" REPLACEMENT O-RING
3/4" X 3/4" X 3/4"	4Z MNW100	4Z MPW100	4Z GW100E

LONG RADIUS ELBOWS



SIZE	NY-GLASS
1-1/2" MPT X MPT	4Z MNL150MM
1-1/2" MPT X FPT	4Z MNL150MF
1-1/2" MPT X SHANK	4Z MNL150MH
2" MPT X MPT	4Z MNL200MM
2" MPT X FPT	4Z MNL200MF
2" MPT X SHANK	4Z MNL200MH

Cam-Operated Couplers and Adapters

PRICING CODE

4Z

3/4" ELBOWS – NY-GLASS



SIZE	
Adapter x FPT	4Z MNL075AF
Adapter x MPT	4Z MNL075AM
MPT x FPT	4Z MNL075MF
MPT x MPT	4Z MNL075MM
MPT x MPT Long Neck	4Z MNL075LMM
MPT x Hose Shank	4Z MNL075MH

3/4" ADAPTER STRIP NOZZLE TIPS



SIZE	NOZZLE NUMBER	NY-GLASS SINGLE TIP	NY-GLASS DOUBLE TIP
3/32"	15.00	4Z ANSS015	4Z ANSD015
7/64"	20.00	4Z ANSS020	4Z ANSD020
9/64"	30.00	4Z ANSS030	4Z ANSD030
5/32"	40.00	4Z ANSS040	4Z ANSD040
3/16"	60.00	4Z ANSS060	4Z ANSD060
7/32"	80.00	4Z ANSS080	4Z ANSD080
15/64"	100.00	4Z ANSS100	4Z ANSD100
1/4"	120.00	4Z ANSS120	4Z ANSD120
19/64"	150.00	4Z ANSS150	4Z ANSD150
21/64"	200.00	4Z ANSS200	4Z ANSD200

Cam-Operated Coupling Gaskets

PRICING CODE

4G



SIZE	BUNA-N	EPDM	VITON	WHITE FDA GRADE	POLYETHYLENE SHIMS
3/4"	4Z GB075	4Z GE075	4Z GV075	4Z GF075	4Z GS075
1"	4Z GB100	4Z GE100	4Z GV100	4Z GF100	4Z GS100
1-1/2"	4Z GB150	4Z GE150	4Z GV150	4Z GF150	4Z GS150
2"	4Z GB200	4Z GE200	4Z GV200	4Z GF200	4Z GS200
3"	4Z GB300	4Z GE300	4Z GV300	4Z GF300	4Z GS300
4"	4Z GB400	4Z GE400	4Z GV400	4Z GF400	4Z GS400

Metal Cam-Operated Couplers and Adapters

PRICING CODE

3A

PART A – ADAPTER X FEMALE NPT



SIZE	ALUM	STAINLESS STEEL	BRASS
3/4"	3A A075A	3A S075A	-
1"	3A A100A	3A S100A	3A B100A
1-1/4"	3A A125A	3A S125A	-
1-1/2"	3A A150A	3A S150A	3A B150A
2"	3A A200A	3A S200A	3A B200A
2-1/2"	3A A250A	3A S250A	3A B250A
3"	3A A300A	3A S300A	3A B300A
4"	3A A400A	3A S400A	3A B400A
6"	3A A600A	3A S600A	-

PART B – COUPLER X MALE NPT



SIZE	ALUM	STAINLESS STEEL	BRASS
3/4"	3A A075B	3A S075B	-
1"	3A A100B	3A S100B	3A B100B
1-1/4"	3A A125B	3A S125B	-
1-1/2"	3A A150B	3A S150B	3A B150B
2"	3A A200B	3A S200B	3A B200B
2-1/2"	3A A250B	3A S250B	3A B250B
3"	3A A300B	3A S300B	3A B300B
4"	3A A400B	3A S400B	3A B400B
6"	3A A600B	3A S600B	-

Metal Cam-Operated Couplers and Adapters

PRICING CODE

3A

PART C – COUPLER X HOSE SHANK



SIZE	ALUM	STAINLESS STEEL	BRASS
3/4"	3A A075C	3A S075C	-
1"	3A A100C	3A S100C	3A B100C
1-1/4"	3A A125C	3A S125C	-
1-1/2"	3A A150C	3A S150C	3A B150C
2"	3A A200C	3A S200C	3A B200C
2-1/2"	3A A250C	3A S250C	3A B250C
3"	3A A300C	3A S300C	3A B300C
4"	3A A400C	3A S400C	3A B400C
6"	3A A600C	3A S600C	-
8"	3A A800C	-	-

PART D – COUPLER X FEMALE NPT



SIZE	ALUM	STAINLESS STEEL	BRASS
3/4"	3A A075D	3A S075D	-
1"	3A A100D	3A S100D	3A B100D
1-1/4"	3A A125D	3A S125D	-
1-1/2"	3A A150D	3A S150D	3A B150D
2"	3A A200D	3A S200D	3A B200D
2-1/2"	3A A250D	3A S250D	3A B250D
3"	3A A300D	3A S300D	3A B300D
4"	3A A400D	3A S400D	3A B400D
6"	3A A600D	3A S600D	-
8"	3A A800D	-	-

Metal Cam-Operated Couplers and Adapters

PRICING CODE

3A

PART E – ADAPTER X HOSE SHANK



SIZE	ALUM	STAINLESS STEEL	BRASS
3/4"	3A A075E	3A S075E	-
1"	3A A100E	3A S100E	3A B100E
1-1/4"	3A A125E	3A S125E	-
1-1/2"	3A A150E	3A S150E	3A B150E
2"	3A A200E	3A S200E	3A B200E
2-1/2"	3A A250E	3A S250E	3A B250E
3"	3A A300E	3A S300E	3A B300E
4"	3A A400E	3A S400E	3A B400E
6"	3A A600E	3A S600E	-
8"	3A A800E	-	-

PART F – ADAPTER X MALE NPT



SIZE	ALUM	STAINLESS STEEL	BRASS
3/4"	3A A075F	3A S075F	-
1"	3A A100F	3A S100F	3A B100F
1-1/4"	3A A125F	3A S125F	-
1-1/2"	3A A150F	3A S150F	3A B150F
2"	3A A200F	3A S200F	3A B200F
2-1/2"	3A A250F	3A S250F	3A B250F
3"	3A A300F	3A S300F	3A B300F
4"	3A A400F	3A S400F	3A B400F
6"	3A A600F	3A S600F	-

Metal Cam-Operated Couplers and Adapters

PRICING CODE

3A

PART DC – COUPLER DUST CAP



SIZE	ALUM	STAINLESS STEEL	BRASS
3/4"	3A A075ZDC	3A S075ZDC	-
1"	3A A100ZDC	3A S100ZDC	3A B100ZDC
1-1/4"	3A A125ZDC	3A S125ZDC	-
1-1/2"	3A A150ZDC	3A S150ZDC	3A B150ZDC
2"	3A A200ZDC	3A S200ZDC	3A B200ZDC
2-1/2"	3A A250ZDC	3A S250ZDC	3A B250ZDC
3"	3A A300ZDC	3A S300ZDC	3A B300ZDC
4"	3A A400ZDC	3A S400ZDC	3A B400ZDC
6"	3A A600ZDC	3A S600ZDC	-

PART DP – ADAPTER DUST PLUG



SIZE	ALUM	STAINLESS STEEL	BRASS
3/4"	3A A075ZDP	3A S075ZDP	-
1"	3A A100ZDP	3A S100ZDP	3A B100ZDP
1-1/4"	3A A125ZDP	3A S125ZDP	-
1-1/2"	3A A150ZDP	3A S150ZDP	3A B150ZDP
2"	3A A200ZDP	3A S200ZDP	3A B200ZDP
2-1/2"	3A A250ZDP	3A S250ZDP	3A B250ZDP
3"	3A A300ZDP	3A S300ZDP	3A B300ZDP
4"	3A A400ZDP	3A S400ZDP	3A B400ZDP
6"	3A A600ZDP	3A S600ZDP	-

Metal Cam-Operated Couplers and Adapters

PRICING CODE

3A

COMBINATION NIPPLES



SIZE	STAINLESS STEEL	UNPLATED STEEL	PLATED STEEL
1/2"	3A CNSS050	3A CNS050	3A CNSP050
3/4"	3A CNSS075	3A CNS075	3A CNSP075
1"	3A CNSS100	3A CNS100	3A CNSP100
1-1/4"	3A CNSS125	3A CNS125	3A CNSP125
1-1/2"	3A CNSS150	3A CNS150	3A CNSP150
2"	3A CNSS200	3A CNS200	3A CNSP200
2-1/2"	3A CNSS250	3A CNS250	3A CNSP250
3"	3A CNSS300	3A CNS300	3A CNSP300
4"	3A CNSS400	3A CNS400	3A CNSP400

“Air King” Universal Coupling – Air Service Only

PRICING CODE

3A

2-LUG



SIZE	HOSE END (MALLEABLE IRON)	MALE END (MALLEABLE IRON)	FEMALE END (MALLEABLE IRON)
1/4"	-	-	3A MFE025
3/8"	-	3A MME037	3A MFE037
1/2"	3A MHE050	3A MME050	3A MFE050
3/4"	3A MHE075	3A MME075	3A MFE075
1"	3A MHE100	3A MME100	3A MFE100

“Air King” Universal Coupling – Air Service Only

PRICING CODE

3A

4-LUG



SIZE	HOSE END (MALLEABLE IRON)	FEMALE END
1-1/4"	3A MHE125	3A MFE125
1-1/2"	3A MHE150	3A MFE150
2"	3A MHE200	3A MFE200

“Air King” Universal Coupling – Air Service Only

PRICING CODE | 3A

WASHER/REPLACEMENT GASKET



DESC	RUBBER
2 Lug	3A MRG2
4 Lug	3A MRG4

OTHERS



DESC	MALLEABLE IRON
3-Way Connector	3A MTE3
Dead End	3A MDE075
Pin & Lanyard	3A LCL



FITTINGS STYLES

PRICING CODE	DESCRIPTION	PAGE
8J	John Guest Auto-Lock Acetal Push Connect Fittings	D1
8J	John Guest Superseal Fittings	D19
8J	John Guest Metric Acetal Push Connect Fittings	D21
8J	John Guest Ag Air Equipment Repair Kit	D35
8J	John Guest Polypropylene Push Connect Fittings – White	D37
8J	John Guest White Polypropylene Service & Repair Kit	D46
8J	John Guest Polypropylene Push Connect Fittings – Black	D47
8J	John Guest Black Polypropylene Service & Repair Kit	D51
8J	John Guest Ag Liquid Equipment Repair Kit	D52
8J-PF	John Guest Speedfit Plumbing Fittings – White	D53
8J-PF	John Guest Speedfit Plumbing Fittings – Black	D59
8J-PL	John Guest ProLock Plumbing Fittings	D63
8J-SB	Shark Bite Brass Plumbing Fittings	D67
8S	SeaTech / AquaLock™ Plumbing Fittings	D75
7H	Stainless Steel Push-In Fittings	D81
7H	Nickel-Plated Push-In Fittings	D83
8A	Plastic Hose Barb & Pipe Fittings	D85
7A	Brass Fittings	D107
8T	Schedule 80 Polypropylene Pipe Fittings	D139
7T	316 Stainless Steel Hose Barbs	D145
7M	Stainless Steel Pipe Fittings	D147
7M	Stainless Steel Pipe, Hex & Reducing Nipples	D153
8X	Spears PVC Fittings	D158

**THIS PAGE IS
INTENTIONALLY
LEFT BLANK**

JG John Guest Auto-Lock Acetal Push Connect Fittings

PRICING CODE **8J**



The PI Range of inch-size push-in fittings is offered for tube sizes 5/32" O.D. to 1/2" O.D. The fittings are manufactured in gray acetal copolymer with food grade nitrile O-ring, making them especially suitable for applicants involving foodstuff and potable liquids. They are also suitable for air and inert gases and can therefore be used in CO2 lines, pneumatic applications and vacuum.

WORKING PRESSURES AND TEMPERATURES:

- 5/32"-5/16": Max. 230 psi at 68°F, Max. 150 psi at 150°F
- 3/8"-1/2": Max. 150 psi at 68°F, Max. 100 psi at 150°F

PART MC - MALE CONNECTOR - NPTF THREAD



PART #	JG PART #	TUBE O.D.	THREAD NPTF	BAG QTY
8J MC532180	PM010421S	5/32"	1/8"	10
8J MC532140	PM010422S	5/32"	1/4"	10
8J MC316180	PI010621S	3/16"	1/8"	10
8J MC140180	PI010821S	1/4"	1/8"	10
8J MC140140	PI010822S	1/4"	1/4"	10
8J MC140380	PI010823S	1/4"	3/8"	10
8J MC516180	PM010821S	5/16"	1/8"	10
8J MC516140	PM010822S	5/16"	1/4"	10
8J MC516380	PM010823S	5/16"	3/8"	10
8J MC380180	PI011221S	3/8"	1/8"	10
8J MC380140	PI011222S	3/8"	1/4"	10
8J MC380380	PI011223S	3/8"	3/8"	10
8J MC380120	PI011224S	3/8"	1/2"	10
8J MC120380	PI011623S	1/2"	3/8"	10
8J MC120120	PI011624S	1/2"	1/2"	10
8J MC580340	PI012026S	5/8"	3/4"	10

PART MC - MALE CONNECTOR - BSPT THREAD



PART #	JG PART #	TUBE O.D.	THREAD BSPT	BAG QTY
8J MC532180BSPT	PM010401S	5/32"	1/8"	10
8J MC532140BSPT	PM010402S	5/32"	1/4"	10
8J MC316180BSPT	PI010601S	3/16"	1/8"	10
8J MC316140BSPT	PI010602S	3/16"	1/4"	10
8J MC140180BSPT	PI010801S	1/4"	1/8"	10
8J MC140140BSPT	PI010802S	1/4"	1/4"	10
8J MC516180BSPT	PM010801S	5/16"	1/8"	10
8J MC516140BSPT	PM010802S	5/16"	1/4"	10
8J MC516380BSPT	PM010803S	5/16"	3/8"	10
8J MC380140BSPT	PI011202S	3/8"	1/4"	10
8J MC380380BSPT	PI011203S	3/8"	3/8"	10
8J MC120380BSPT	PI011603S	1/2"	3/8"	10
8J MC120120BSPT	PI011604S	1/2"	1/2"	10



John Guest Auto-Lock Acetal Push Connect Fittings

PRICING CODE

8J



PART MC - MALE CONNECTOR - BSPP THREAD



PART #	JG PART #	TUBE O.D.	THREAD BSPT	BAG QTY
8J MC140140BSPP	PI010812S	1/4"	1/4"	10
8J MC380140BSPP	PI011212S	3/8"	1/4"	10
8J MC380380BSPP	PI011213S	3/8"	3/8"	10

PART UC - UNION CONNECTOR



PART #	JG PART #	TUBE O.D.	BAG QTY
8J UC532	PM0404S	5/32"	10
8J UC316	PI0406S	3/16"	10
8J UC140	PI0408S	1/4"	10
8J UC516	PM0408S	5/16"	10
8J UC380	PI0412S	3/8"	10
8J UC120	PI0416S	1/2"	10

PART RUC - REDUCING UNION CONNECTOR



PART #	JG PART #	TUBE O.D.	TUBE O.D.	BAG QTY
8J RUC140316	PI200806S	1/4"	3/16"	10
8J RUC516532	PM200804S	5/16"	5/32"	10
8J RUC516316	PI201006S	5/16"	3/16"	10
8J RUC516140	PI201008S	5/16"	1/4"	10
8J RUC380316	PI201206S	3/8"	3/16"	10
8J RUC380140	PI201208S	3/8"	1/4"	10
8J RUC380516	PI201210S	3/8"	5/16"	10
8J RUC120140	PI201608S	1/2"	1/4"	10
8J RUC120516	PI201610S	1/2"	5/16"	10
8J RUC120380	PI201612S	1/2"	3/8"	10

John Guest Auto-Lock Acetal Push Connect Fittings

PRICING CODE

8J



PART ULC - UNION ELBOW CONNECTOR



PART #	JG PART #	TUBE O.D.	BAG QTY
8J ULC532	PM0304S	5/32"	10
8J ULC316	PI0306S	3/16"	10
8J ULC140	PI0308S	1/4"	10
8J ULC516	PM0308S	5/16"	10
8J ULC380	PI0312S	3/8"	10
8J ULC120	PI0316S	1/2"	10

PART RLC - REDUCING ELBOW CONNECTOR



PART #	JG PART #	TUBE O.D.	TUBE O.D.	BAG QTY
8J RLC516532	PM210804S	5/16"	5/32"	10
8J RLC516316	PI211006S	5/16"	3/16"	10
8J RLC516140	PI211008S	5/16"	1/4"	10
8J RLC380316	PI211206S	3/8"	3/16"	10
8J RLC380140	PI211208S	3/8"	1/4"	10
8J RLC380516	PI211210S	3/8"	5/16"	10
8J RLC120516	PI211610S	1/2"	5/16"	10
8J RLC120380	PI211612S	1/2"	3/8"	10

PART ME - MALE FIXED ELBOW



PART #	JG PART #	TUBE O.D.	THREAD NPTF	BAG QTY
8J ME140180	PI480821S	1/4"	1/8"	10
8J ME140140	PI480822S	1/4"	1/4"	10
8J ME140380	PI480823S	1/4"	3/8"	10
8J ME516140	PI481022S	5/16"	1/4"	10
8J ME516380	PI481023S	5/16"	3/8"	10
8J ME380140	PI481222S	3/8"	1/4"	10
8J ME380380	PI481223S	3/8"	3/8"	10
8J ME580120	PI482024S	5/8"	1/2"	10

JG John Guest Auto-Lock Acetal Push Connect Fittings

PRICING CODE 8J



PART SE - SWIVEL ELBOW - NPTF THREAD



PART #	JG PART #	TUBE O.D.	THREAD NPTF	BAG QTY
8J SE532180	PM090421S	5/32"	1/8"	10
8J SE532140	PM090422S	5/32"	1/4"	10
8J SE316180	PI090621S	3/16"	1/8"	10
8J SE140180	PI090821S	1/4"	1/8"	10
8J SE140140	PI090822S	1/4"	1/4"	10
8J SE516180	PM090821S	5/16"	1/8"	10
8J SE516140	PM090822S	5/16"	1/4"	10
8J SE516380	PM090823S	5/16"	3/8"	10
8J SE380180	PI091221S	3/8"	1/8"	10
8J SE380140	PI091222S	3/8"	1/4"	10
8J SE380380	PI091223S	3/8"	3/8"	10
8J SE120140	PI091622S	1/2"	1/4"	10
8J SE120380	PI091623S	1/2"	3/8"	10
8J SE120120	PI091624S	1/2"	1/2"	10

PART SE - SWIVEL ELBOW - BSPT THREAD



PART #	JG PART #	TUBE O.D.	THREAD BSPT	BAG QTY
8J SE316180BSPT	PI090601S	3/16"	1/8"	10
8J SE140180BSPT	PI090801S	1/4"	1/8"	10
8J SE140140BSPT	PI090802S	1/4"	1/4"	10
8J SE516180BSPT	PM090801S	5/16"	1/8"	10
8J SE516140BSPT	PM090802S	5/16"	1/4"	10
8J SE516380BSPT	PM090803S	5/16"	3/8"	10
8J SE380140BSPT	PI091202S	3/8"	1/4"	10
8J SE380380BSPT	PI091203S	3/8"	3/8"	10
8J SE120380BSPT	PI091603S	1/2"	3/8"	10
8J SE120120BSPT	PI091604S	1/2"	1/2"	10

PART FSE - FEMALE SWIVEL ELBOW - GARDEN HOSE THREAD



PART #	JG PART #	TUBE O.D.	THREAD NH	BAG QTY
8J FSE380340	NC2723	3/8"	3/4"-11.5	5
8J FSE380340P	NC2723P	3/8"	3/4"-11.5	1

John Guest Auto-Lock Acetal Push Connect Fittings

PRICING CODE | 8J



PART UTC - UNION TEE CONNECTOR



PART #	JG PART #	TUBE O.D.	BAG QTY
8J UTC532	PM0204S	5/32"	10
8J UTC316	PI0206S	3/16"	10
8J UTC140	PI0208S	1/4"	10
8J UTC516	PM0208S	5/16"	10
8J UTC380	PI0212S	3/8"	10
8J UTC120	PI0216S	1/2"	10

PART UTCR - UNION TEE REDUCING CONNECTOR



PART #	JG PART #	TUBE O.D. ENDS	TUBE O.D. BRANCH	BAG QTY
8J UTCR380140	PI301208S	3/8"	1/4"	10
8J UTCR120380	PI301612S	1/2"	3/8"	10

PART SMRT - SWIVEL MALE RUN TEE - NPTF THREAD



PART #	JG PART #	TUBE O.D.	THREAD NPTF	BAG QTY
8J SMRT532180	PM110421S	5/32"	1/8"	10
8J SMRT532140	PM110422S	5/32"	1/4"	10
8J SMRT316180	PI110621S	3/16"	1/8"	10
8J SMRT140180	PI110821S	1/4"	1/8"	10
8J SMRT140140	PI110822S	1/4"	1/4"	10
8J SMRT516180	PM110821S	5/16"	1/8"	10
8J SMRT516140	PM110822S	5/16"	1/4"	10
8J SMRT516380	PM110823S	5/16"	3/8"	10
8J SMRT380140	PI111222S	3/8"	1/4"	10
8J SMRT380380	PI111223S	3/8"	3/8"	10
8J SMRT120380	PI111623S	1/2"	3/8"	10
8J SMRT120120	PI111624S	1/2"	1/2"	10

John Guest Auto-Lock Acetal Push Connect Fittings

PRICING CODE

8J



PART SBT - SWIVEL BRANCH TEE - NPTF THREAD



PART #	JG PART #	TUBE O.D.	THREAD NPTF	BAG QTY
8J SBT532180	PM100421S	5/32"	1/8"	10
8J SBT532140	PM100422S	5/32"	1/4"	10
8J SBT316180	PI100621S	3/16"	1/8"	10
8J SBT140180	PI100821S	1/4"	1/8"	10
8J SBT140140	PI100822S	1/4"	1/4"	10
8J SBT516180	PM100821S	5/16"	1/8"	10
8J SBT516140	PM100822S	5/16"	1/4"	10
8J SBT516380	PM100823S	5/16"	3/8"	10
8J SBT380140	PI101222S	3/8"	1/4"	10
8J SBT380380	PI101223S	3/8"	3/8"	10
8J SBT120380	PI101623S	1/2"	3/8"	5
8J SBT120120	PI101624S	1/2"	1/2"	5

PART SBT - SWIVEL BRANCH TEE - BSPT THREAD



PART #	JG PART #	TUBE O.D.	THREAD BSPT	BAG QTY
8J SBT140180BSPT	PI100801S	1/4"	1/8"	10
8J SBT140140BSPT	PI100802S	1/4"	1/4"	10
8J SBT516380BSPT	PM100803S	5/16"	3/8"	10
8J SBT380140BSPT	PI101202S	3/8"	1/4"	10
8J SBT380380BSPT	PI101203S	3/8"	3/8"	10
8J SBT120380BSPT	PI101603S	1/2"	3/8"	5
8J SBT120120BSPT	PI101604S	1/2"	1/2"	5

JG John Guest Auto-Lock Acetal Push Connect Fittings

PRICING CODE

8J



PART MT - MALE TUBE STEM ADAPTER - NPTF THREAD



PART #	JG PART #	STEM O.D.	THREAD NPTF	BAG QTY
8J MT532180	PM050421S	5/32"	1/8"	10
8J MT532140	PM050422S	5/32"	1/4"	10
8J MT316180	PI050621S	3/16"	1/8"	10
8J MT140180	PI050821S	1/4"	1/8"	10
8J MT140140	PI050822S	1/4"	1/4"	10
8J MT140380	PI050823S	1/4"	3/8"	10
8J MT516180	PM050821S	5/16"	1/8"	10
8J MT516140	PM050822S	5/16"	1/4"	10
8J MT516380	PM050823S	5/16"	3/8"	10
8J MT380140	PI051222S	3/8"	1/4"	10
8J MT380380	PI051223S	3/8"	3/8"	10
8J MT120380	PI051623S	1/2"	3/8"	10
8J MT120120	PI051624S	1/2"	1/2"	10

PART MT - MALE TUBE STEM ADAPTER - BSPT THREAD



PART #	JG PART #	STEM O.D.	THREAD BSPT	BAG QTY
8J MT316180BSPT	PI050601S	3/16"	1/8"	10
8J MT140180BSPT	PI050801S	1/4"	1/8"	10
8J MT140140BSPT	PI050802S	1/4"	1/4"	10
8J MT516180BSPT	PM050801S	5/16"	1/8"	10
8J MT516140BSPT	PM050802S	5/16"	1/4"	10
8J MT516380BSPT	PM050803S	5/16"	3/8"	10
8J MT380140BSPT	PI051202S	3/8"	1/4"	10
8J MT380380BSPT	PI051203S	3/8"	3/8"	10
8J MT120380BSPT	PI051603S	1/2"	3/8"	10
8J MT120120BSPT	PI051604S	1/2"	1/2"	10

JG John Guest Auto-Lock Acetal Push Connect Fittings

PRICING CODE

8J



PART MT - MALE TUBE STEM ADAPTER - BSPP THREAD



PART #	JG PART #	STEM O.D.	THREAD BSPP	BAG QTY
8J MT51614BSPP	PM050812S	5/16"	1/4"	10
8J MT38014BSPP	PI051212S	3/8"	1/4"	10
8J MT38038BSPP	PI051213S	3/8"	3/8"	10

PART TP - STEM PLUG



PART #	JG PART #	STEM O.D.	BAG QTY
8J TP532	PM0804S	5/32"	10
8J TP316	PI0806S	3/16"	10
8J TP140	PI0808S	1/4"	10
8J TP516	PM0808S	5/16"	10
8J TP380	PI0812S	3/8"	10
8J TP120	PI0816S	1/2"	10

PART FC - FEMALE CONNECTOR - NPT THREAD



PART #	JG PART #	TUBE O.D.	THREAD NPT	BAG QTY
8J FC140140NPT	PI450822S	1/4"	1/4" NPTF	10
8J FC380140NPT	PI451222S	3/8"	1/4" NPTF	10

JG John Guest Auto-Lock Acetal Push Connect Fittings

PRICING CODE | 8J



PART FC - FEMALE CONNECTOR - FFL THREAD



PART #	JG PART #	TUBE O.D.	THREAD FFL	BAG QTY
8J FC516140FFL	PM4508F4S	5/16"	1/4" FFL	10
8J FC380140FFL	PI4512F4S	3/8"	1/4" FFL	10
8J FC380380FFL	PI4512F6S	3/8"	3/8" FFL	10

PART FC - FEMALE CONNECTOR - BSPP THREAD - FLAT END



PART #	JG PART #	TUBE O.D.	THREAD BSPP	BAG QTY
8J FC516120BSPPF	PI451014FS	5/16"	1/2" BSPP	10
8J FC516580BSPPF	PI451015FS	5/16"	5/8" BSPP	10
8J FC380380BSPPF	PI451213S	3/8"	3/8" BSPP	10
8J FC380120BSPPF	PI451214FS	3/8"	1/2" BSPP	10
8J FC380580BSPPF	PI451215FS	3/8"	5/8" BSPP	10
8J FC120380BSPPF	PI451613S	1/2"	3/8" BSPP	10
8J FC120580BSPPF	PI451615FS	1/2"	5/8" BSPP	10

PART FC - FEMALE CONNECTOR - BSPP THREAD - CONE END



PART #	JG PART #	TUBE O.D.	THREAD BSPP	BAG QTY
8J FC516120BSPPC	PI451014CS	5/16"	1/2" BSPP	10
8J FC516580BSPPC	PI451015CS	5/16"	5/8" BSPP	10
8J FC380120BSPPC	PI451214CS	3/8"	1/2" BSPP	10
8J FC380580BSPPC	PI451215CS	3/8"	5/8" BSPP	10
8J FC120120BSPPC	PI451614CS	1/2"	1/2" BSPP	10
8J FC120340BSPPC	PI451616CS	1/2"	3/4" BSPP	10

John Guest Auto-Lock Acetal Push Connect Fittings

PRICING CODE

8J



PART FC - FEMALE CONNECTOR - BSP THREAD



PART #	JG PART #	TUBE O.D.	THREAD BSP	BAG QTY
8J FC140340BSP	CI320816FS	1/4"	3/4" BSP	10
8J FC380340BSP	CI321216FS	3/8"	3/4" BSP	10

PART FA - FAUCET ADAPTER - UNS THREAD



PART #	JG PART #	TUBE O.D.	THREAD UNS	BAG QTY
8J FA716140	CI3208U7S	1/4"	7/16"-24 UNS	10
8J FA716380	CI3212U7S	3/8"	7/16"-24 UNS	10
8J FA716516	CI3210U7S	5/16"	7/16"-24 UNS	10

PART FA - FAUCET ADAPTER - BSPP THREAD



PART #	JG PART #	TUBE O.D.	THREAD BSPP	BAG QTY
8J FA120140BSPP	CI320814S	1/4"	1/2" BSPP	10
8J FA340140BSPP	CI320816S	1/4"	3/4" BSPP	10
8J FA120380BSPP	CI321214S	3/8"	1/2" BSPP	10
8J FA340380BSPP	CI321216S	3/8"	3/4" BSPP	10

John Guest Auto-Lock Acetal Push Connect Fittings

PRICING CODE

8J



PART BUC - BULKHEAD UNION CONNECTOR



PART #	JG PART #	TUBE O.D.	MOUNTING HOLE	BAG QTY
8J BUC532532	PM1204S	5/32"	0.67"	10
8J BUC316316	PI1206S	3/16"	0.67"	10
8J BUC140140	PI1208S	1/4"	0.67"	10
8J BUC516516	PM1208S	5/16"	0.83"	10
8J BUC380380	PI1212S	3/8"	0.83"	10
8J BUC380140	PI121208S	3/8" X 1/4"	0.83"	10
8J BUC120140	NC392-02	1/2" X 1/4"	0.83"	150
8J BUC120120	PI1216S	1/2"	1.06"	5

PART ENL - ENLARGER



PART #	JG PART #	STEM O.D.	TUBE O.D.	BAG QTY
8J ENL516380	PI131012S	5/16"	3/8"	10
8J ENL380120	PI131216S	3/8"	1/2"	10

PART 2WDC - TWO-WAY DIVIDER CONNECTOR



PART #	JG PART #	TUBE O.D. INLET	TUBE O.D. OUTLET	BAG QTY
8J 2WDC140	PI2308S	1/4"	1/4"	10
8J 2WDC516	PM2308S	5/16"	5/16"	10
8J 2WDC380	PI2312S	3/8"	3/8"	10
8J 2WDC120	PI2316S	1/2"	1/2"	5
8J U2WDC380516	PI241210S	3/8"	5/16"	10

PART 3WDC - THREE WAY DIVIDER



PART #	JG PART #	TUBE O.D. INLET	TUBE O.D. OUTLET	BAG QTY
8J 3WDC120380X3	PI491612S	1/2"	3/8"	10
8J 3WDC120	PI491616S	1/2"	1/2"	10
8J 3WDC380	PI491212S-R	3/8"	3/8"	10

JG John Guest Auto-Lock Acetal Push Connect Fittings

PRICING CODE

8J



PART TEC - TUBE STEM PLUG IN ELBOW CONNECTOR



PART #	JG PART #	STEM O.D.	TUBE O.D.	BAG QTY
8J TEC532532	PM220404S	5/32"	5/32"	10
8J TEC316316	PI220606S	3/16"	3/16"	10
8J TEC380316	PI221206S	3/8"	3/16"	10
8J TEC140140	PI220808S	1/4"	1/4"	10
8J TEC380140	PI221208S	3/8"	1/4"	10
8J TEC516516	PM220808S	5/16"	5/16"	10
8J TEC380516	PI221210S	3/8"	5/16"	10
8J TEC380380	PI221212S	3/8"	3/8"	10
8J TEC120120	PI221616S	1/2"	1/2"	10

PART TS - TUBE STEM HOSE BARB



PART #	JG PART #	STEM O.D.	HOSE I.D.	BAG QTY
8J TS140316	PI250806S	1/4"	3/16"	10
8J TS140140	PI250808S	1/4"	1/4"	10
8J TS140516	PI250810S	1/4"	5/16"	10
8J TS516316	PI251006S	5/16"	3/16"	10
8J TS516140	PI251008S	5/16"	1/4"	10
8J TS516516	PM250808S	5/16"	5/16"	10
8J TS516380	PI251012S	5/16"	3/8"	10
8J TS516380L	PI251012SL	5/16"	3/8" LONG	10
8J TS380140	PI251208S	3/8"	1/4"	10
8J TS380516	PI251210S	3/8"	5/16"	10
8J TS380380	PI251212S	3/8"	3/8"	10
8J TS380380L	PI251212SL	3/8"	3/8" LONG	10
8J TS380120	PI251216S	3/8"	1/2"	10
8J TS120380	PI251612S	1/2"	3/8"	10
8J TS120120	PI251616S	1/2"	1/2"	10

JG John Guest Auto-Lock Acetal Push Connect Fittings

PRICING CODE | 8J



PART TLS - TUBE STEM TO HOSE BARB ELBOW



PART #	JG PART #	STEM O.D.	HOSE I.D.	BAG QTY
8J TLS140140	PI290808S	1/4"	1/4"	10
8J TLS140516	PI290810S	1/4"	5/16"	10
8J TLS516140	PI291008S	5/16"	1/4"	10
8J TLS516516	PM290808S	5/16"	5/16"	10
8J TLS380140	PI291208S	3/8"	1/4"	10
8J TLS380516	PI291210S	3/8"	5/16"	10

PART ES - END STOP



PART #	JG PART #	TUBE O.D.	BAG QTY
8J ES140	PI4608S	1/4"	10
8J ES380	PI4612S	3/8"	10

PART TRC - STEM REDUCER CONNECTOR



PART #	JG PART #	STEM O.D.	TUBE O.D.	BAG QTY
8J TRC316532	PI060605S	3/16"	5/32"	10
8J TRC516316	PI061006S	5/16"	3/16"	10
8J TRC380316	PI061206S	3/8"	3/16"	10
8J TRC516140	PI061008S	5/16"	1/4"	10
8J TRC380140	PI061208S	3/8"	1/4"	10
8J TRC380516	PI061210S	3/8"	5/16"	10
8J TRC120516	PI061610S	1/2"	5/16"	10
8J TRC120380	PI061612S	1/2"	3/8"	10

John Guest Auto-Lock Acetal Push Connect Fittings

PRICING CODE | 8J



PART CR - CROSS



PART #	JG PART #	TUBE O.D.	BAG QTY
8J CR380380	PI4712S	3/8"	10

PART TSI - TUBE INSERT



PART #	JG PART #	TUBE O.D.	TUBE I.D.	BAG QTY
8J TSI516140	TSI250S	5/16"	1/4"	10
8J TSI380516	TSI312S	3/8"	5/16"	100
8J TSI120380	TSI375S	1/2"	3/8"	10

PART MCF - FLARE MALE CONNECTOR



PART #	JG PART #	TUBE O.D.	THREAD MFL	BAG QTY
8J MCF140140	PI0108F4S	1/4"	1/4"	10
8J MCF516516	PM0108F5S	5/16"	5/16"	10
8J MCF516120MFL	PM0108C5S	5/16"	1/2"-16 UN	10
8J MCF380140	PI0112F4S	3/8"	1/4"	10
8J MCF380516	PI0112F5S	3/8"	5/16"	10
8J MCF380380	PI0112F6S	3/8"	3/8"	10
8J MCF380120	PI0112F8S	3/8"	1/2"	10
8J MCF380120MFL	PI0112C5S	3/8"	1/2"-16 UN	10
8J MCF120120	PI0116F8S	1/2"	1/2"	10

PART UB - U-BEND



PART #	JG PART #	TUBE O.D.	BAG QTY
8J UB380	PIUB12S	3/8"	10
8J UB120	PIUB16S	1/2"	10

John Guest Auto-Lock Acetal Push Connect Fittings

PRICING CODE

8J



PART FBC - FLOW BEND CLIP



PART #	JG PART #	TUBE O.D.	BAG QTY
8J FBC516	PM2608S	5/16"	10
8J FBC380	PM2610S	3/8"	10
8J FBC120	PM2612S	1/2"	5

PART LC - LOCKING CLIP



PART #	JG PART #	TUBE O.D.	BAG QTY
8J LC140	PIC1808R	1/4"	100
8J LC516	PMC1808R	5/16"	100
8J LC380	PIC1812R	3/8"	100
8J LC120	PIC1816R	1/2"	100

PART CC - COLLET COVERS



PART #	JG PART #	TUBE O.D.	BAG QTY
8J CC532	PM1904S	5/32"	10
8J CC316	PI1906S	3/16"	10
8J CC140	PI1908S	1/4"	10
8J CC516	PM1908S	5/16"	10
8J CC380	PI1912S	3/8"	10
8J CC120	PI1916S	1/2"	10

Note: Colors Available

B=Blue, G=Gray, BK=Black, GN=Green, R=Red, Y=Yellow

JG John Guest Auto-Lock Acetal Push Connect Fittings

PRICING CODE | 8J



RELEASE TOOLS AND CUTTERS



PART #	JG PART #	ITEM	SIZE	BAG QTY
8J MRTS	ICLT/2	COLLECT LOCKING TOOL	3/16" - 1/2"	1
8J M50	TSNIP	TUBE CUTTER	—	1
8J MRT140X380	TSPITool	RELEASE TOOL	1/4" & 3/8"	10
8J M50/BLADE	BLADES	REPLACEMENT BLADES	—	10

SPARE O-RINGS



PART #	JG PART #	SIZE	MATERIAL
8J SPR532	CPR04MS	5/32"	NITRILE
8J SPR316	CPR05MS	3/16"	NITRILE
8J SPR140	CPR08IS	1/4"	NITRILE
8J SPR140E	CAR08IS	1/4"	EPDM
8J SPR140VIT	F7001108	1/4"	VITON
8J SPR516	CPR08MS	5/16"	NITRILE
8J SPR516E	CAR08MS	5/16"	EPDM
8J SPR380	CPR12IS	3/8"	NITRILE
8J SPR380E	CAR12IS	3/8"	EPDM
8J SPR380VIT	F7001110	3/8"	VITON
8J SPR120	CPR16IS	1/2"	NITRILE
8J SPR120E	CAR16IS	1/2"	EPDM

PART BGHT - BRASS GARDEN HOSE THREAD FEMALE CONNECTOR



PART #	JG PART #	TUBE O.D.	THREAD NH	BAG QTY
8J BGHT380340	NC2258	3/8"	3/4"-11.5	10
8J BGHTLF140340	NC2098LF	1/4"	3/4"-11.5	10

John Guest Auto-Lock Acetal Push Connect Fittings

PRICING CODE | 8J



PART FCB - BRASS FLARE FEMALE CONNECTOR - FFL THREAD



PART #	JG PART #	TUBE O.D.	THREAD FFL	BAG QTY
8J FCBLF140140FFL	MI4508F4SLF	1/4"	1/4" FFL	10
8J FCBLF380140FFL	MI4512F4SLF	3/8"	1/4" FFL	10
8J FCBLF380380FFL	MI4512F6SLF	3/8"	3/8" FFL	10

PART FCB - BRASS FLARE FEMALE CONNECTOR - BSPP THREAD



PART #	JG PART #	TUBE O.D.	THREAD BSPP	BAG QTY
8J FCBLF140340BSPP	NC2145LF	1/4"	3/4" BSPP	10
8J FCBLF380340BSPP	NC2249LF	3/8"	3/4" BSPP	10

PART HC - HALF CARTRIDGE - BRASS BODY



PART #	JG PART #	TUBE O.D.
8J HC532	MM2804N	5/32"
8J HC316	MI2806N	3/16"
8J HC140	MI2808N	1/4"
8J HC140E	CI2808W	1/4"
8J HC516	MM2808N	5/16"
8J HC380	MI2812N	3/8"
8J HC380E	CI2812N	3/8"
8J HC120	MI2816N	1/2"
8J HC580E	CI2820N	5/8"

* "E" in Part Numbers indicate an EPDM O-ring

John Guest Auto-Lock Acetal Push Connect Fittings

PRICING CODE | 8J



PART HCS - HALF CARTRIDGE - STAINLESS STEEL BODY



PART #	JG PART #	TUBE O.D.
8J HCS316	MI2806ST	3/16"
8J HCS140	MI2808ST	1/4"
8J HCS516	MM2808ST	5/16"
8J HCS380	MI2812ST	3/8"

PART HCP - HALF CARTRIDGE - PLASTIC BODY



PART #	JG PART #	TUBE O.D.
8J HCP532	PM2804S	5/32"
8J HCP316	PI2806S	3/16"
8J HCP140	PI2808S	1/4"
8J HCP140E	PCI2808S	1/4"
8J HCP516	PM2808S	5/16"
8J HCP516E	PCM2808S	5/16"
8J HCP380	PI2812S	3/8"
8J HCP380E	PCI2812S	3/8"
8J HCP120	PI2816S	1/2"
8J HCP120E	PCI2816S	1/2"

*"E" in Part Numbers indicate an EPDM O-ring

PART CV - CHECK VALVE



PART #	JG PART #	TUBE O.D.	BAG QTY
8J CV140	1/4SCV	1/4"	10
8J CV516	5/16SCV	5/16"	10
8J CV380	3/8SCV	3/8"	1
8J CV120	1/2CSV	1/2"	10

John Guest Superseal Fittings

PRICING CODE | 8J



For use with Stainless Steel Tubing

The SI Range of inch-size push-in fittings is offered for tube sizes 1/4" O.D. to 3/8" O.D. Superseal is a special fitting designed to provide extra grip on stainless steel tubes. The Superseal design features a collet with integrally molded stainless steel teeth similar to the standard Super Speedfit design, but incorporating an additional hand-operated nut and wedge shaped plastic washer to apply extra pressure to the collet and the double O-ring seals. This ensures that the collet teeth bite thoroughly into the tube to provide grip, while at the same time compressing the o-rings to further enhance sealing.

WORKING PRESSURES AND TEMPERATURES:

- 1/4"-5/16": Max. 230 psi at 68°F, Max. 150 psi at 150°F
- 3/8": Max. 150 psi at 68°F, Max. 100 psi at 150°F

PART SSC - UNION CONNECTOR - SUPERSEAL - SPEEDFIT



PART #	JG PART #	SUPERSEAL O.D.	SPEEDFIT O.D.	BAG QTY
8J SSC516516	SM040808S	5/16"	5/16"	10
8J SSC516380	SI041012S	5/16"	3/8"	10
8J SSC380516	SI041210S	3/8"	5/16"	10
8J SSC380380	SI041212S	3/8"	3/8"	10

PART SEC - UNION ELBOW - SUPERSEAL - SPEEDFIT



PART #	JG PART #	SUPERSEAL O.D.	SPEEDFIT O.D.	BAG QTY
8J SEC140380	SI030812S	1/4"	3/8"	10
8J SEC516516	SM030808S	5/16"	5/16"	10
8J SEC516380	SI031012S	5/16"	3/8"	10
8J SEC380516	SI031210S	3/8"	5/16"	10
8J SEC380380	SI031212S	3/8"	3/8"	10
8J SEC380120	SI041216S	3/8"	1/2"	10

PART SDEC - UNION ELBOW CONNECTOR - SUPERSEAL



PART #	JG PART #	SUPERSEAL O.D.	BAG QTY
8J SDEC516516	SM400808S	5/16" X 5/16"	10
8J SDEC380516	SI401210S	3/8" X 5/16"	10
8J SDEC380380	SI401212S	3/8" X 3/8"	10

John Guest Superseal Fittings

PRICING CODE 8J



PART SMCF - FLARE MALE CONNECTOR - SUPERSEAL - MFL THREAD



PART #	JG PART #	SUPERSEAL O.D.	SPEEDFIT O.D.	BAG QTY
8J SMCF516140	SM0108F4S	5/16"	1/4"	10
8J SMCF516380	SM0108F6S	5/16"	3/8"	10

PART SBC - SWIVEL BARB CONNECTOR - SUPERSEAL



PART #	JG PART #	SUPERSEAL O.D.	HOSE I.D.	BAG QTY
8J SBC140140	SI270808S	1/4"	1/4"	10
8J SBC516140	SI271008S	5/16"	1/4"	10
8J SBC380140	SI271208S	3/8"	1/4"	10

PART SFBE - FLOW BEND CONNECTOR - SUPERSEAL - SPEEDFIT



PART #	JG PART #	SUPERSEAL O.D.	SPEEDFIT O.D.	BAG QTY
8J SFBE516516	SM420808S	5/16"	5/16"	10
8J SFBE516380	SI421012S	5/16"	3/8"	10
8J SFBE380380	SI421210S	3/8"	5/16"	10
8J SFBE380380	SI421212S	3/8"	3/8"	10

SUPERSEAL SPANNER TOOL



PART #	JG PART #	ITEM	SIZE	BAG QTY
8J MSSS	SPAN1	SS SPANNER	5/16" & 3/8"	1

JG John Guest Metric Acetal Push Connect Fittings

PRICING CODE **8J**



The PM Range of metric-size push-in fittings is offered for tube sizes 4mm O.D. to 28mm O.D. The fittings are manufactured in black acetal copolymer with food grade nitrile O-rings. Especially produced for foodstuff and potable liquids, they are equally suitable for air and inert gases and can therefore be used on CO2 lines, pneumatics applications and vacuum.

WORKING PRESSURES AND TEMPERATURES:

- 4mm-8mm: Max. 230 psi at 68°F, Max. 150 psi at 150°F
- 10mm-22mm: Max. 150 psi at 68°F, Max. 100 psi at 150°F

PART MC - MALE CONNECTOR - BSPT THREAD



PART #	JG PART #	TUBE O.D. (MM)	THREAD BSPT (IN)	BAG QTY
8J MC4MM180BSPT	PM010401E	4	1/8"	10
8J MC4MM140BSPT	PM010402E	4	1/4"	10
8J MC5MM180BSPT	PM010501E	5	1/8"	10
8J MC5MM140BSPT	PM010502E	5	1/4"	10
8J MC6MM180BSPT	PM010601E	6	1/8"	10
8J MC6MM140BSPT	PM010602E	6	1/4"	10
8J MC8MM180BSPT	PM010801E	8	1/8"	10
8J MC8MM140BSPT	PM010802E	8	1/4"	10
8J MC8MM380BSPT	PM010803E	8	3/8"	10
8J MC10MM140BSPT	PM011002E	10	1/4"	10
8J MC10MM380BSPT	PM011003E	10	3/8"	10
8J MC10MM120BSPT	PM011004E	10	1/2"	10
8J MC12MM380BSPT	PM011203E	12	3/8"	10
8J MC12MM120BSPT	PM011204E	12	1/2"	10
8J MC15MM120BSPT	CM011514S	15	1/2"	10

JG John Guest Metric Acetal Push Connect Fittings

PRICING CODE 8J



PART MC - MALE CONNECTOR - BSPP THREAD



PART #	JG PART #	TUBE O.D. (MM)	THREAD BSPP (IN)	BAG QTY
8J MC4MM180BSPP	PM010411E	4	1/8"	10
8J MC4MM140BSPP	PM010412E	4	1/4"	10
8J MC5MM180BSPP	PM010511E	5	1/8"	10
8J MC5MM140BSPP	PM010512E	5	1/4"	10
8J MC6MM180BSPP	PM010611E	6	1/8"	10
8J MC6MM140BSPP	PM010612E	6	1/4"	10
8J MC8MM180BSPP	PM010811E	8	1/8"	10
8J MC8MM140BSPP	PM010812E	8	1/4"	10
8J MC8MM380BSPP	PM010813E	8	3/8"	10
8J MC10MM140BSPP	PM011012E	10	1/4"	10
8J MC10MM380BSPP	PM011013E	10	3/8"	10
8J MC10MM120BSPP	PM011014E	10	1/2"	10
8J MC12MM380BSPP	PM011213E	12	3/8"	10
8J MC12MM120BSPP	PM011214E	12	1/2"	10
8J MC15MM120BSPP	PM011514E	15	1/2"	10
8J MC18MM120BSPP	PM011814E	18	1/2"	10
8J MC22MM340BSPP	PM012216E	22	3/4"	10

PART MC - MALE CONNECTOR - NPTF THREAD



PART #	JG PART #	TUBE O.D. (MM)	THREAD NPTF (IN)	BAG QTY
8J MC6MM140	PM010622E	6	1/4" (NPTF)	10

JG John Guest Metric Acetal Push Connect Fittings

PRICING CODE

8J



PART UC - UNION CONNECTOR



PART #	JG PART #	TUBE O.D. (MM)	BAG QTY
8J UC4MM	PM0404E	4	10
8J UC5MM	PM0405E	5	10
8J UC6MM	PM0406E	6	10
8J UC8MM	PM0408E	8	10
8J UC10MM	PM0410E	10	10
8J UC12MM	PM0412E	12	10
8J UC15MM	PM0415E	15	10
8J UC18MM	PM0418E	18	10
8J UC22MM	PM0422E	22	10
8J UC28MM	PM0428E	28	10

PART RUC - REDUCING UNION CONNECTOR



PART #	JG PART #	TUBE O.D. (MM)	TUBE O.D. (MM)	BAG QTY
8J RUC6MM4MM	PM200604E	6	4	10
8J RUC8MM4MM	PM200804E	8	4	10
8J RUC8MM6MM	PM200806E	8	6	10
8J RUC10MM4MM	PM201004E	10	4	10
8J RUC10MM6MM	PM201006E	10	6	10
8J RUC10MM8MM	PM201008E	10	8	10
8J RUC12MM8MM	PM201208E	12	8	10
8J RUC12MM10MM	PM201210E	12	10	10
8J RUC15MMX12	NC471	15	1/2"	5
8J RUC15MMX12O	NC462	15	1/2"	10
8J RUC15MMX380	NC2511	15	3/8"	10



John Guest Metric Acetal Push Connect Fittings

PRICING CODE

8J



PART ULC - UNION ELBOW CONNECTOR



PART #	JG PART #	TUBE O.D. (MM)	BAG QTY
8J ULC4MM	PM0304E	4	10
8J ULC5MM	PM0305E	5	10
8J ULC6MM	PM0306E	6	10
8J ULC8MM	PM0308E	8	10
8J ULC10MM	PM0310E	10	10
8J ULC12MM	PM0312E	12	10
8J ULC15MM	PM0315E	15	10
8J ULC18MM	PM0318E	18	10
8J ULC22MM	PM0322E	22	10
8J ULC28MM	PM0328E	28	10

PART RLC - REDUCING ELBOW CONNECTOR



PART #	JG PART #	TUBE O.D. (MM)	TUBE O.D. (MM)	BAG QTY
8J RLC6MM4MM	PM210604E	6	4	10
8J RLC8MM4MM	PM210804E	8	4	10
8J RLC8MM6MM	PM210806E	8	6	10
8J RLC10MM4MM	PM211004E	10	4	10
8J RLC10MM6MM	PM211006E	10	6	10
8J RLC10MM8MM	PM211008E	10	8	10
8J RLC12MM8MM	PM211208E	12	8	10
8J RLC12MM10MM	PM211210E	12	10	10

PART ME - MALE FIXED ELBOW - NPTF THREAD



PART #	JG PART #	TUBE O.D. (MM)	THREAD NPTF (IN)	BAG QTY
8J ME6MM180	PM480621E	6	1/8"	10
8J ME6MM140	PM480622E	6	1/4"	10
8J ME6MM380	PM480623E	6	3/8"	10



John Guest Metric Acetal Push Connect Fittings

PRICING CODE

8J



PART SE - SWIVEL ELBOW - BSPT THREAD



PART #	JG PART #	TUBE O.D. (MM)	THREAD BSPT (IN)	BAG QTY
8J SE4MM180BSPT	PM090401E	4	1/8"	10
8J SE4MM140BSPT	PM090402E	4	1/4"	10
8J SE5MM180BSPT	PM090501E	5	1/8"	10
8J SE5MM140BSPT	PM090502E	5	1/4"	10
8J SE6MM180BSPT	PM090601E	6	1/8"	10
8J SE6MM140BSPT	PM090602E	6	1/4"	10
8J SE8MM180BSPT	PM090801E	8	1/8"	10
8J SE8MM140BSPT	PM090802E	8	1/4"	10
8J SE8MM380BSPT	PM090803E	8	3/8"	10
8J SE10MM140BSPT	PM091002E	10	1/4"	10
8J SE10MM380BSPT	PM091003E	10	3/8"	10
8J SE10MM120BSPT	PM091004E	10	1/2"	10
8J SE12MM380BSPT	PM091203E	12	3/8"	10
8J SE12MM120BSPT	PM091204E	12	1/2"	10

PART SE - SWIVEL ELBOW - BSPP THREAD



PART #	JG PART #	TUBE O.D. (MM)	THREAD BSPP (IN)	BAG QTY
8J SE4MM180BSPP	PM090411E	4	1/8"	10
8J SE4MM140BSPP	PM090412E	4	1/4"	10
8J SE5MM180BSPP	PM090511E	5	1/8"	10
8J SE5MM140BSPP	PM090512E	5	1/4"	10
8J SE6MM180BSPP	PM090611E	6	1/8"	10
8J SE6MM140BSPP	PM090612E	6	1/4"	10
8J SE8MM180BSPP	PM090811E	8	1/8"	10
8J SE8MM140BSPP	PM090812E	8	1/4"	10
8J SE8MM380BSPP	PM090813E	8	3/8"	10
8J SE10MM140BSPP	PM091012E	10	1/4"	10
8J SE10MM380BSPP	PM091013E	10	3/8"	10
8J SE10MM120BSPP	PM091014E	10	1/2"	10
8J SE12MM380BSPP	PM091213E	12	3/8"	10
8J SE12MM120BSPP	PM091214E	12	1/2"	10



John Guest Metric Acetal Push Connect Fittings

PRICING CODE

8J



PART UTC - UNION TEE CONNECTOR



PART #	JG PART #	TUBE O.D. (MM)	BAG QTY
8J UTC4MM	PM0204E	4	10
8J UTC5MM	PM0205E	5	10
8J UTC6MM	PM0206E	6	10
8J UTC8MM	PM0208E	8	10
8J UTC10MM	PM0210E	10	10
8J UTC12MM	PM0212E	12	10
8J UTC15MM	PM0215E	15	10
8J UTC18MM	PM0218E	18	10
8J UTC22MM	PM0222E	22	10
8J UTC28MM	PM0228E	28	10

PART UTCR - UNION TEE REDUCING CONNECTOR



PART #	JG PART #	TUBE O.D. ENDS (MM)	TUBE O.D. BRANCH (MM)	BAG QTY
8J UTCR18MM15MM	PM3018AE	18	15	5
8J UTCR22MM15MM	PM3022AE	22	15	5

PART SMRT - SWIVEL MALE RUN TEE - BSPT THREAD



PART #	JG PART #	TUBE O.D. (MM)	THREAD BSPT (IN)	BAG QTY
8J SMRT6MM140BSPT	PM110602E	6	1/4"	10
8J SMRT8MM140BSPT	PM110802E	8	1/4"	10



John Guest Metric Acetal Push Connect Fittings

PRICING CODE

8J



PART SMRT - SWIVEL MALE RUN TEE - BSPP THREAD



PART #	JG PART #	TUBE O.D. (MM)	THREAD BSPP (IN)	BAG QTY
8J SMRT4MM180BSPP	PM110411E	4	1/8"	10
8J SMRT6MM180BSPP	PM110611E	6	1/8"	10
8J SMRT6MM140BSPP	PM110612E	6	1/4"	10
8J SMRT8MM140BSPP	PM110812E	8	1/4"	10
8J SMRT8MM380BSPP	PM110813E	8	3/8"	10
8J SMRT10MM140BSPP	PM111012E	10	1/4"	10
8J SMRT12MM380BSPP	PM111213E	12	3/8"	10

PART SBT - SWIVEL BRANCH TEE - BSPT THREAD



PART #	JG PART #	TUBE O.D. (MM)	THREAD BSPT (IN)	BAG QTY
8J SBT4MM180BSPT	PM100401E	4	1/8"	10
8J SBT4MM140BSPT	PM100402E	4	1/4"	10
8J SBT5MM180BSPT	PM100501E	5	1/8"	10
8J SBT5MM140BSPT	PM100502E	5	1/4"	10
8J SBT6MM180BSPT	PM100601E	6	1/8"	10
8J SBT6MM140BSPT	PM100602E	6	1/4"	10
8J SBT8MM180BSPT	PM100801E	8	1/8"	10
8J SBT8MM140BSPT	PM100802E	8	1/4"	10
8J SBT8MM380BSPT	PM100803E	8	3/8"	10
8J SBT10MM140BSPT	PM101002E	10	1/4"	10
8J SBT10MM380BSPT	PM101003E	10	3/8"	10
8J SBT10MM120BSPT	PM101004E	10	1/2"	10
8J SBT12MM380BSPT	PM101203E	12	3/8"	10
8J SBT12MM120BSPT	PM101204E	12	1/2"	10



John Guest Metric Acetal Push Connect Fittings

PRICING CODE

8J



PART SBT - SWIVEL BRANCH TEE - BSPP THREAD



PART #	JG PART #	TUBE O.D. (MM)	THREAD BSPP (IN)	BAG QTY
8J SBT4MM180BSPP	PM100411E	4	1/8"	10
8J SBT4MM140BSPP	PM100412E	4	1/4"	10
8J SBT5MM180BSPP	PM100511E	5	1/8"	10
8J SBT5MM140BSPP	PM100512E	5	1/4"	10
8J SBT6MM180BSPP	PM100611E	6	1/8"	10
8J SBT6MM140BSPP	PM100612E	6	1/4"	10
8J SBT8MM180BSPP	PM100811E	8	1/8"	10
8J SBT8MM140BSPP	PM100812E	8	1/4"	10
8J SBT8MM380BSPP	PM100813E	8	3/8"	10
8J SBT10MM140BSPP	PM101012E	10	1/4"	10
8J SBT10MM380BSPP	PM101013E	10	3/8"	10
8J SBT10MM120BSPP	PM101014E	10	1/2"	10
8J SBT12MM380BSPP	PM101213E	12	3/8"	10
8J SBT12MM120BSPP	PM101214E	12	1/2"	10

PART MT - MALE TUBE STEM ADAPTER - BSPT THREAD



PART #	JG PART #	STEM O.D. (MM)	THREAD BSPT (IN)	BAG QTY
8J MT4MM180BSPT	PM050401E	4	1/8"	10
8J MT4MM140BSPT	PM050402E	4	1/4"	10
8J MT5MM180BSPT	PM050501E	5	1/8"	10
8J MT5MM140BSPT	PM050502E	5	1/4"	10
8J MT6MM180BSPT	PM050601E	6	1/8"	10
8J MT6MM140BSPT	PM050602E	6	1/4"	10
8J MT8MM180BSPT	PM050801E	8	1/8"	10
8J MT8MM140BSPT	PM050802E	8	1/4"	10
8J MT8MM380BSPT	PM050803E	8	3/8"	10
8J MT10MM140BSPT	PM051002E	10	1/4"	10
8J MT10MM380BSPT	PM051003E	10	3/8"	10
8J MT10MM120BSPT	PM051004E	10	1/2"	10
8J MT12MM380BSPT	PM051203E	12	3/8"	10
8J MT12MM120BSPT	PM051204E	12	1/2"	10

JG John Guest Metric Acetal Push Connect Fittings

PRICING CODE

8J



PART MT - MALE TUBE STEM ADAPTER - BSPP THREAD



PART #	JG PART #	STEM O.D. (MM)	THREAD BSPP (IN)	BAG QTY
8J MT4MM180BSPP	PM050411E	4	1/8"	10
8J MT4MM140BSPP	PM050412E	4	1/4"	10
8J MT5MM180BSPP	PM050511E	5	1/8"	10
8J MT5MM140BSPP	PM050512E	5	1/4"	10
8J MT6MM180BSPP	PM050611E	6	1/8"	10
8J MT6MM140BSPP	PM050612E	6	1/4"	10
8J MT8MM180BSPP	PM050811E	8	1/8"	10
8J MT8MM140BSPP	PM050812E	8	1/4"	10
8J MT8MM380BSPP	PM050813E	8	3/8"	10
8J MT10MM140BSPP	PM051012E	10	1/4"	10
8J MT10MM380BSPP	PM051013E	10	3/8"	10
8J MT10MM120BSPP	PM051014E	10	1/2"	10
8J MT12MM380BSPP	PM051213E	12	3/8"	10
8J MT12MM120BSPP	PM051214E	12	1/2"	10
8J MT15MM380BSPP	PM051513E	15	3/8"	10
8J MT15MM120BSPP	PM051514E	15	1/2"	10
8J MT18MM120BSPP	PM051814E	18	1/2"	10
8J MT22MM120BSPP	PM052214E	22	1/2"	10
8J MT22MM340BSPP	PM052216E	22	3/4"	10

PART TP - STEM PLUG



PART #	JG PART #	STEM O.D. (MM)	BAG QTY
8J TP4MM	PM0804R	4	10
8J TP5MM	PM0805R	5	10
8J TP6MM	PM0806R	6	10
8J TP8MM	PM0808R	8	10
8J TP10MM	PM0810R	10	10
8J TP12MM	PM0812R	12	10



John Guest Metric Acetal Push Connect Fittings

PRICING CODE

8J



PART FC - FEMALE CONNECTOR - BSPP THREAD



PART #	JG PART #	TUBE O.D. (MM)	THREAD BSPP (IN)	BAG QTY
8J FC4MM180BSPP	PM450411E	4	1/8"	10
8J FC6MM180BSPP	PM450611E	6	1/8"	10
8J FC6MM140BSPP	PM450612E	6	1/4"	10
8J FC8MM140BSPP	PM450812E	8	1/4"	10
8J FC8MM380BSPP	PM450813E	8	3/8"	10
8J FC10MM580BSPP	PM451015FE	10	5/8"	10
8J FC12MM580BSPP	PM451215FE	12	5/8"	10

PART BUC - BULKHEAD UNION CONNECTOR



PART #	JG PART #	TUBE O.D. (MM)	MOUNTING HOLE DIA. (MM)	BAG QTY
8J BUC4MM	PM1204E	4	16.5	10
8J BUC5MM	PM1205E	5	16.5	10
8J BUC6MM	PM1206E	6	16.5	10
8J BUC8MM	PM1208E	8	21	10
8J BUC10MM	PM1210E	10	21	10
8J BUC12MM	PM1212E	12	26.5	10

PART ENL - ENLARGER



PART #	JG PART #	STEM O.D. (MM)	TUBE O.D. (MM)	BAG QTY
8J ENL4MM5MM	PM130405E	4	5	10

PART 2WDC - TWO-WAY DIVIDER CONNECTOR



PART #	JG PART #	TUBE O.D. (MM)	BAG QTY
8J 2WDC4MM	PM2304E	4	10
8J 2WDC8MM	PM2308E	8	10
8J 2WDC10MM	PM2310E	10	10
8J 2WDC15MM	PM2315E	15	5

JG John Guest Metric Acetal Push Connect Fittings

PRICING CODE **8J**



PART TEC - TUBE STEM PLUG IN ELBOW CONNECTOR



PART #	JG PART #	TUBE O.D. (MM)	STEM O.D. (MM)	BAG QTY
8J TEC4MM	PM220404E	4	4	10
8J TEC5MM	PM220505E	5	5	10
8J TEC6MM	PM220606E	6	6	10
8J TEC8MM	PM220808E	8	8	10
8J TEC10MM	PM221010E	10	10	10
8J TEC12MM	PM221212E	12	12	10
8J TEC15MM	PM221515E	15	15	10
8J TEC18MM	PM221818E	18	18	10
8J TEC22MM	PM222222E	22	22	10

PART TS - TUBE STEM TO HOSE BARB



PART #	JG PART #	STEM O.D. (MM)	HOSE I.D. (MM)	BAG QTY
8J TS6MM4MM	PM250604E	6	4	10
8J TS8MM6MM	PM250806E	8	6	10
8J TS10MM8MM	PM251008E	10	8	10
8J TS15MM120	NC932	15	1/2"	10

PART TSS - TUBE STEM TO TUBE STEM



PART #	JG PART #	STEM O.D. (MM)	HOSE I.D. (MM)	BAG QTY
8J TSS15MM380	NC478	15	3/8"	10



John Guest Metric Acetal Push Connect Fittings

PRICING CODE

8J



PART ES - END STOP



PART #	JG PART #	TUBE O.D. (MM)	BAG QTY
8J ES12MM	PM4612E	12	10
8J ES15MM	PM4615E	15	10
8J ES18MM	PM4618E	18	10
8J ES22MM	PM4622E	22	5

PART TRC - STEM REDUCER CONNECTOR



PART #	JG PART #	STEM O.D. (MM)	TUBE O.D. (MM)	BAG QTY
8J TRC5MM4MM	PM060504E	5	4	10
8J TRC6MM4MM	PM060604E	6	4	10
8J TRC6MM5MM	PM060605E	6	5	10
8J TRC8MM4MM	PM060804E	8	4	10
8J TRC8MM5MM	PM060805E	8	5	10
8J TRC8MM6MM	PM060806E	8	6	10
8J TRC10MM6MM	PM061006E	10	6	10
8J TRC10MM8MM	PM061008E	10	8	10
8J TRC12MM8MM	PM061208E	12	8	10
8J TRC12MM10MM	PM061210E	12	10	10
8J TRC15MM10MM	PM061510E	15	10	10
8J TRC15MM12MM	PM061512E	15	12	10
8J TRC18MM15MM	PM061815E	18	15	10
8J TRC22MM15MM	PM062215E	22	15	10
8J TRC22MM18MM	PM062218E	22	18	10
8J TRC28MM15MM	PM062815E	28	15	10
8J TRC28MM22MM	PM062822E	28	22	10
8J TRC15MM380	NC2164	15	3/8"	10
8J TRC12015MM	NC2173	1/2"	15	10
8J TRC12018MM	NC908	1/2"	18	10

John Guest Metric Acetal Push Connect Fittings

PRICING CODE 8J



PART TSI - TUBE INSERT



PART #	JG PART #	TUBE O.D.	BAG QTY
8J TSI10MM	TSM10N	10	50
8J TSI15MM	TSM15N	15	50
8J TSI22MM	TSM22N	22	25

PART UB - U-BEND



PART #	JG PART #	TUBE O.D. (MM)	BAG QTY
8J UB15MM	PMUB15E	15	10

SPARE O-RINGS



PART #	JG PART #	TUBE O.D. (MM)	MATERIAL
8J SPR6MM	CPR06MS	6	NITRILE

PART LC - LOCKING CLIP



PART #	JG PART #	TUBE O.D.
8J LC6MM	PM1806R	6
8J LC8MM	PMC1808R	8
8J LC15MM	CM1815R	15

JG John Guest Metric Acetal Push Connect Fittings

PRICING CODE

8J



PART HC - HALF CARTRIDGE - BRASS BODY



PART #	JG PART #	TUBE O.D.
8J HC4MM	MM2804N	4
8J HC5MM	MM2805N	5
8J HC6MM	MM2806N	6
8J HC8MM	MM2808N	8
8J HC10MM	MM2810N	10
8J HC12MM	MM2812N	12

PART HCP - HALF CARTRIDGE - PLASTIC BODY



PART #	JG PART #	TUBE O.D.
8J HCP4MM	PM2804E	4
8J HCP5MMBP	PM2805E	5
8J HCP6MM	PM2806E	6
8J HCP8MM	PM2808E	8
8J HCP10MM	PM2810E	10
8J HCP12MM	PM2812E	12

John Guest Ag Air Equipment Repair Kit

PRICING CODE **8J**

GREY ACETAL PUSH-CONNECT FITTINGS FOR AIR APPLICATIONS



KIT DIMENSIONS:

Width	Depth	Height
11"	7-1/4"	1-3/4"

CUSTOMIZED WITH YOUR LOGO

Your Logo - We can customize kits with your logo on both the inside and outside cover, driving customers back to your business.

Your Preferred Fittings - We can modify kit configurations to meet your requirements. Let us know which Push-Connect fittings you prefer!

PART #	DESCRIPTION	QTY
8J 2WDC380	TWO-WAY DIVIDER 3/8" OD	2
8J RUC380140	REDUCING UNION 3/8" OD x 1/4" OD	4
8J UTC140	TEE CONNECTOR 1/4" OD	4
8J MC140140	MALE CONNECTOR 1/4" OD x 1/4" MPT	7
8J MT140140	MALE STEM ADAPTER 1/4" TUBE x 1/4" MPT	6
8J MC380140	MALE CONNECTOR 3/8" OD x 1/4" MPT	4
8J ME140380	MALE ELBOW 1/4" OD x 3/8" MPT	3
8J UC140	UNION CONNECTOR 1/4" OD	8
8J M50	M50 TUBE CUTTER	1
8J ME140140	MALE ELBOW 1/4" OD x 1/4" MPT	6
8J ULC140	ELBOW CONNECTOR 1/4" OD	6
8J 2WDC140	TWO-WAY DIVIDER 1/4" OD	4
8J TEC380380	TUBE STEM ELBOW CONN. 3/8" OD x 3/8" TUBE	4
8J ME380140	MALE ELBOW 3/8" OD x 1/4" MPT	4
8J UC380	UNION CONNECTOR 3/8" OD	4
8J ME380380	MALE ELBOW 3/8" OD x 3/8" MPT	3
8J ULC380	ELBOW CONNECTOR 3/8" OD	3
8J TS380380	BARB CONNECTOR 3/8" BARB x 3/8" TUBE	4
TOTAL		77

**THIS PAGE IS
INTENTIONALLY
LEFT BLANK**

John Guest Polypropylene Push Connect Fittings – White

PRICING CODE | 8J



The PP Range of inch-size push-in fittings is offered for tube sizes 1/4" O.D. to 1/2" O.D. The fittings are manufactured in white polypropylene with food grade EPDM O-rings. They have been developed to satisfy the filtered pure water market and wide range of applications.

The PPM Range is NOT suitable for compressed air applications.

WORKING PRESSURES AND TEMPERATURES:

- Max. 150 psi at 70°F (Max. 10 Bar at 20°C)
- Max. 60 psi at 140°F (Max. 4 Bar at 60°C)
- Min. 33°F/1°C

PART MC - MALE CONNECTOR - NPTF THREAD



PART #	JG PART #	TUBE O.D.	THREAD NPTF	BAG QTY
8J MC140180WP	PP010821W	1/4"	1/8"	10
8J MC140140WP	PP010822W	1/4"	1/4"	10
8J MC140380WP	PP010823W	1/4"	3/8"	10
8J MC140120WP	PP010824W	1/4"	1/2"	10
8J MC380140WP	PP011222W	3/8"	1/4"	10
8J MC380380WP	PP011223W	3/8"	3/8"	10
8J MC380120WP	PP011224W	3/8"	1/2"	10
8J MC120380WP	PP011623W	1/2"	3/8"	10
8J MC120120WP	PP011624W	1/2"	1/2"	10

PART UC - UNION CONNECTOR



PART #	JG PART #	TUBE O.D.	BAG QTY
8J UC140WP	PP0408W	1/4"	10
8J UC380WP	PP0412W	3/8"	10
8J UC516WP	PPM0408W	5/16"	10
8J UC120WP	PP0416W	1/2"	10

PART RUC - REDUCING UNION CONNECTOR



PART #	JG PART #	TUBE O.D.	TUBE O.D.	BAG QTY
8J RUC516140WP	NC2099P	5/16"	1/4"	1
8J RUC380140WP	PP201208W	3/8"	1/4"	10
8J RUC120380WP	PP201612W	1/2"	3/8"	10

John Guest Polypropylene Push Connect Fittings – White

PRICING CODE | 8J



PART ULC - UNION ELBOW CONNECTOR



PART #	JG PART #	TUBE O.D.	BAG QTY
8J ULC140WP	PP0308W	1/4"	10
8J ULC380WP	PP0312W	3/8"	10
8J ULC516WP	PPM0308W	5/16"	10
8J ULC120WP	PP0316W	1/2"	10

PART RLC - REDUCING ELBOW CONNECTOR



PART #	JG PART #	TUBE O.D.	TUBE O.D.	BAG QTY
8J RLC516140WP	PP211008W	5/16"	1/4"	10
8J RLC380140WP	PP211208W	3/8"	1/4"	10
8J RLC120380WP	PP211612W	1/2"	3/8"	10

PART ME - MALE FIXED ELBOW - NPTF THREAD



PART #	JG PART #	TUBE O.D.	THREAD NPTF	BAG QTY
8J ME140180WP	PP480821W	1/4"	1/8"	10
8J ME140140WP	PP480822W	1/4"	1/4"	10
8J ME140380WP	PP480823W	1/4"	3/8"	10
8J ME380140WP	PP481222W	3/8"	1/4"	10
8J ME380380WP	PP481223W	3/8"	3/8"	10
8J ME120380WP	PP481623W	1/2"	3/8"	10

PART SE - SWIVEL ELBOW - NPTF THREAD



PART #	JG PART #	TUBE O.D.	THREAD NPTF	BAG QTY
8J SE140180WP	PP090821W	1/4"	1/8"	10
8J SE140140WP	PP090822W	1/4"	1/4"	10
8J SE380140WP	PP091222W	3/8"	1/4"	10
8J SE380380WP	PP091223W	3/8"	3/8"	10

John Guest Polypropylene Push Connect Fittings – White

PRICING CODE | 8J



PART UTC - UNION TEE CONNECTOR



PART #	JG PART #	TUBE O.D.	BAG QTY
8J UTC140WP	PP0208W	1/4"	10
8J UTC380WP	PP0212W	3/8"	10
8J UTC516WP	PPM0208W	5/16"	10
8J UTC120WP	PP0216W	1/2"	10

PART UTCR - UNION TEE REDUCING CONNECTOR



PART #	JG PART #	TUBE O.D. END	TUBE O.D. END	TUBE O.D. BRANCH	BAG QTY
8J UTCR140140380WP	PP30080812W	1/4"	1/4"	3/8"	10
8J UTCR380140WP	PP30121208W	3/8"	1/4"	3/8"	10
8J UTCR381438WP	PP30120812W	3/8"	3/8"	1/4"	10
8J UTCR120380WP	PP301612W	1/2"	1/2"	3/8"	10

PART UTCSR - TUBE STEM PLUG IN TEE CONNECTOR



PART #	JG PART #	TUBE O.D.	STEM O.D.	BAG QTY
8J UTCSR380WP	PP531212W	3/8"	3/8"	10

PART UTCM - UNION TEE MALE CONNECTOR



PART #	JG PART #	TUBE O.D.	NPTF THREAD	BAG QTY
8J UTCM380WP	PP641223W	3/8"	3/8"	10

John Guest Polypropylene Push Connect Fittings – White

PRICING CODE

8J



PART SMRT - SWIVEL MALE RUN TEE - NPTF THREAD



PART #	JG PART #	TUBE O.D.	THREAD NPTF	BAG QTY
8J SMRT140180WP	PP110821W	1/4"	1/8"	10
8J SMRT140140WP	PP110822W	1/4"	1/4"	10
8J SMRT380140WP	PP111222W	3/8"	1/4"	10
8J SMRT380380WP	PP111223W	3/8"	3/8"	10

PART SBT - SWIVEL BRANCH TEE - NPTF THREAD



PART #	JG PART #	TUBE O.D.	THREAD NPTF	BAG QTY
8J SBT140180WP	PP100821W	1/4"	1/8"	10
8J SBT140140WP	PP100822W	1/4"	1/4"	10
8J SBT380140WP	PP101222W	3/8"	1/4"	10
8J SBT380380WP	PP101223W	3/8"	3/8"	10

PART MT - MALE TUBE STEM ADAPTER - NPTF THREAD



PART #	JG PART #	STEM O.D.	THREAD NPTF	BAG QTY
8J MT140180WP	PP050821W	1/4"	1/8"	10
8J MT140140WP	PP050822W	1/4"	1/4"	10
8J MT380140WP	PP051222W	3/8"	1/4"	10
8J MT380380WP	PP051223W	3/8"	3/8"	10
8J MT120380WP	PP051623W	1/2"	3/8"	10
8J MT120120WP	PP051624W	1/2"	1/2"	10

PART TP - STEM PLUG



PART #	JG PART #	STEM O.D.	BAG QTY
8J TP140WP	PP0808W	1/4"	10
8J TP516WP	PPM0808W	5/16"	10
8J TP380WP	PP0812W	3/8"	10
8J TP120WP	PP0816W	1/2"	10

JG John Guest Polypropylene Push Connect Fittings – White

PRICING CODE | 8J



PART FC - FEMALE CONNECTOR - NPTF THREAD



PART #	JG PART #	TUBE O.D.	THREAD NPTF	BAG QTY
8J FC140180NPTWP	PP450821W	1/4"	1/8"	10
8J FC140140NPTWP	PP450822W	1/4"	1/4"	10
8J FC380140NPTWP	PP451222W	3/8"	1/4"	10
8J FC380380NPTWP	PP451223W	3/8"	3/8"	10

PART FC - FEMALE CONNECTOR - UNEF THREAD



PART #	JG PART #	TUBE O.D.	THREAD UNEF	BAG QTY
8J FC380916	PSEI6012U9	3/8"	9/16"-24	10
8J FC140916	PP6008U9W	1/4"	9/16"-24	10

PART FA - FAUCET ADAPTER - UNS THREAD



PART #	JG PART #	TUBE O.D.	THREAD UNS	BAG QTY
8J FA140716WP	PP3208U7W	1/4"	7/16"-24	10
8J FA380716WP	PP3212U7W	3/8"	7/16"-24	10

PART BUC - BULKHEAD UNION CONNECTOR



PART #	JG PART #	STEM O.D.	BAG QTY
8J BUC140140WP	PP1208W	1/4"	10
8J BUC380140WP	PP121208W	3/8" X 1/4"	10
8J BUC380380WP	PP1212W	3/8"	10
8J BUC120120WP	PP1216W	1/2"	5

JG John Guest Polypropylene Push Connect Fittings – White

PRICING CODE | 8J



PART 2WDC - TWO-WAY DIVIDER CONNECTOR



PART #	JG PART #	TUBE O.D. INLET	TUBE O.D. OUTLET	BAG QTY
8J 2WDC380WP	PP2312W	3/8"	3/8"	10

PART U2WDC - UNEQUAL TWO-WAY DIVIDER CONNECTOR



PART #	JG PART #	TUBE O.D. INLET	TUBE O.D. OUTLET	BAG QTY
8J U2WDC380140WP	PP241208W	3/8"	1/4"	10

PART 3WDC- THREE-WAY DIVIDER CONNECTOR



PART #	JG PART #	TUBE O.D. INLET	TUBE O.D. OUTLET	BAG QTY
8J 3WDC380140X3WP	PP491208W	3/8"	1/4"	10

PART TEC - TUBE STEM PLUG IN ELBOW CONNECTOR



PART #	JG PART #	STEM O.D.	TUBE O.D.	BAG QTY
8J TEC140140WP	PP220808W	1/4"	1/4"	10
8J TEC380140WP	PP221208W	3/8"	1/4"	10
8J TEC380380WP	PP221212W	3/8"	3/8"	10
8J TEC516516WP	PPM220808W	5/16"	5/16"	10
8J TEC120120WP	PP221616W	1/2"	1/2"	10

John Guest Polypropylene Push Connect Fittings – White

PRICING CODE | 8J



PART TS - TUBE STEM HOSE BARB



PART #	JG PART #	STEM O.D.	HOSE I.D.	BAG QTY
8J TS380380WP	PP251212W	3/8"	3/8"	10
8J TS380120WP	PP251216W	3/8"	1/2"	10
8J TS120380WP	PP251612W	1/2"	3/8"	10
8J TS120120WP	PP251616W	1/2"	1/2"	10

PART ES - END STOP



PART #	JG PART #	TUBE O.D.	BAG QTY
8J ES140WP	PP4608W	1/4"	10

PART TRC - STEM REDUCER CONNECTOR



PART #	JG PART #	STEM O.D.	TUBE O.D.	BAG QTY
8J TRC380140WP	PP061208W	3/8"	1/4"	10
8J TRC580140WP	PP062008W	5/8"	1/4"	10
8J TRC380516WP	PP061210W	3/8"	5/16"	10
8J TRC120380WP	PP061612W	1/2"	3/8"	10
8J TRC580380WP	PP062012W	5/8"	3/8"	10
8J TRC580120WP	PP062016W	5/8"	1/2"	10

PART HCP - HALF CARTRIDGE - PLASTIC BODY



PART #	JG PART #	TUBE O.D.
8J HCP140WP	PP2808W	1/4"
8J HCP380WP	PP2812W	3/8"



John Guest Metric Polypropylene Push-Connect Fittings – White

PRICING CODE **8J**



The PPM Range of metric size push-in fittings is offered for our tube sizes 8mm O.D. to 15mm O.D. The fittings are manufactured in white polypropylene with EPDM o-rings. They have been developed to satisfy the compatibility needs for a wide range of applications.

The PPM Range is NOT suitable for compressed air applications.

WORKING PRESSURES AND TEMPERATURES:

- Max. 150 psi at 70°F (Max. 10 Bar at 20°C)
- Max. 60 psi at 140°F (Max. 4 Bar at 60°C)
- Min. 33°F/1°C

PART UC - UNION CONNECTOR



PART #	JG PART #	TUBE O.D. (MM)	BAG QTY
8J UC8MMWP	PPM0408W	8	10
8J UC12MMWP	PPM0412W	12	10

PART RUC - REDUCING UNION CONNECTOR



PART #	JG PART #	TUBE O.D. (MM)	TUBE O.D. (MM)	BAG QTY
8J RUC15MM12MMWP	PPM201512W	15	12	10

PART ULC - UNION ELBOW CONNECTOR



PART #	JG PART #	TUBE O.D. (MM)	BAG QTY
8J ULC8MMWP	PPM0308W	8	10
8J ULC12MMWP	PPM0312W	12	10

PART UTC - UNION TEE CONNECTOR



PART #	JG PART #	TUBE O.D. (MM)	BAG QTY
8J UTC8MMWP	PPM0208W	8	10
8J UTC12MMWP	PPM0212W	12	10



John Guest

Metric Polypropylene Push-Connect Fittings – White

PRICING CODE

8J



PART TP - STEM PLUG



PART #	JG PART #	TUBE O.D. (MM)	BAG QTY
8J TP8MMWP	PPM0808W	8	10

PART 2WDC - TWO-WAY DIVIDER CONNECTOR



PART #	JG PART #	TUBE O.D. (MM)	BAG QTY
8J 2WDC12MMWP	PPM2312W	12	10

PART TEC - TUBE STEM PLUG IN ELBOW CONNECTOR



PART #	JG PART #	TUBE O.D. (MM)	STEM O.D. (MM)	BAG QTY
8J TEC8MM8MMWP	PPM220808W	8	8	10
8J TEC12MM12MMWP	PPM221212W	12	12	10

PART TRC - STEM REDUCER CONNECTOR



PART #	JG PART #	TUBE O.D. (MM)	STEM O.D. (MM)	BAG QTY
8J TRC12MM15MMWP	PPM061512W	12	15	10

John Guest White Polypropylene Service & Repair Kit

PRICING CODE

8J



KIT DIMENSIONS:

Width	Depth	Height
15"	11-1/2"	2-1/2"

PART #	DESCRIPTION	QTY
PP010822W	MALE CONNECTOR 1/4" X 1/4"	5
PP011222W	MALE CONNECTOR 3/8" X 1/4"	5
PP011223W	MALE CONNECTOR 3/8" X 3/8"	5
PP0208W	TEE 1/4 "	5
PP0212W	TEE 3/8"	5
PP0308W	ELBOW 1/4"	5
PP0312W	ELBOW 3/8"	5
PP0408W	UNION 1/4"	5
PP0412W	UNION 3/8"	5
PP061208W	REDUCER 3/8" - 1/4"	5
PP201208W	REDUCING UNION 3/8" - 1/4"	5
PP220808W	PLUG-IN ELBOW 1/4" X 1/4"	5
PP221212W	PLUG-IN ELBOW 3/8" X 3/8"	5
PP3208U7W	FEMALE COMPRESSION 1/4" X 1/4"	5
PP3212U7W	FEMALE COMPRESSION 3/8" X 1/4"	5
PP480822W	NPTF FIXED ELBOW 1/4" X 1/4"	5
PP481223W	NPTF FIXED ELBOW 3/8" X 3/8"	5
PPSV040808WP	VALVE 1/4" X 1/4"	3
ASVPP1LF	ASV VALVE 3/8" X 3/8" - 1/4"	2
ASVPP5LF	ASV VALVE 1/2" X 3/8" - 1/4"	1
TSNIP-US	TUBE CUTTER	1
TOTAL		92

John Guest Polypropylene Push Connect Fittings – Black

PRICING CODE 8J



The PP Range of inch-size push-in fittings is offered for tube sizes 1/4" O.D. to 1/2" O.D. The fittings are manufactured in black polypropylene with food grade EPDM O-rings. They have been developed to satisfy the needs of the Water Purification and Beverage Dispensing Markets. Black Polypropylene fittings are U.V. Stabilized and are ideal for use in Agricultural Spraying, Car Wash Chemical Dispense, Farm Machinery, and Dairy Equipment applications.

The PP Range is NOT suitable for compressed air applications.

WORKING PRESSURES & TEMPERATURES:

- Max. 150 psi at 70°F (Max. 10 Bar at 20°C)
- Max. 60 psi at 140°F (Max. 4 Bar at 60°C)
- Min. 33°F/1°C

PART MC - MALE CONNECTOR - NPTF THREAD



PART #	JG PART #	TUBE O.D.	THREAD NPTF	BAG QTY
8J MC140180BP	PP010821E	1/4"	1/8"	10
8J MC140140BP	PP010822E	1/4"	1/4"	10
8J MC140380BP	PP010823E	1/4"	3/8"	10
8J MC380140BP	PP011222E	3/8"	1/4"	10
8J MC380380BP	PP011223E	3/8"	3/8"	10
8J MC380102BP	PP011224E	3/8"	1/2"	10

PART UC - UNION CONNECTOR



PART #	JG PART #	TUBE O.D.	BAG QTY
8J UC140BP	PP0408E	1/4"	10
8J UC516BP	PPM0408E	5/16"	10
8J UC380BP	PP0412E	3/8"	10

PART RUC - REDUCING UNION CONNECTOR



PART #	JG PART #	TUBE O.D.	TUBE O.D.	BAG QTY
8J RUC380140BP	PP201208E	3/8"	1/4"	10
8J RUC120380BP	PP201612E	1/2"	3/8"	10

John Guest Polypropylene Push Connect Fittings – Black

PRICING CODE 8J



PART ULC - UNION ELBOW CONNECTOR



PART #	JG PART #	TUBE O.D.	BAG QTY
8J ULC140BP	PP0308E	1/4"	10
8J ULC380BP	PP0312E	3/8"	10
8J ULC120BP	PP0316E	1/2"	10

PART RLC - REDUCING ELBOW CONNECTOR



PART #	JG PART #	STEM O.D.	TUBE O.D.	BAG QTY
8J RLC380140BP	PP211208E	3/8"	1/4"	10

PART ME - MALE FIXED ELBOW



PART #	JG PART #	TUBE O.D.	THREAD NPTF	BAG QTY
8J ME140180BP	PP480821E	1/4"	1/8"	10
8J ME140140BP	PP480822E	1/4"	1/4"	10
8J ME140380BP	PP280823E	1/4"	3/8"	10
8J ME380140BP	PP481222E	3/8"	1/4"	10
8J ME380380BP	PP481223E	3/8"	3/8"	10

PART UTC - UNION TEE CONNECTOR



PART #	JG PART #	TUBE O.D.	BAG QTY
8J UTC140BP	PP0208E	1/4"	10
8J UTC516BP	PPM0208E	5/16"	10
8J UTC380BP	PP0212E	3/8"	10

John Guest Polypropylene Push Connect Fittings – Black

PRICING CODE

8J



PART MT - MALE TUBE STEM ADAPTER



PART #	JG PART #	STEM O.D.	THREAD NPTF	BAG QTY
8J MT140180BP	PP050821E	1/4"	1/8"	10
8J MT140140BP	PP050822E	1/4"	1/4"	10
8J MT380380BP	PP051223E	3/8"	3/8"	10

PART TP - STEM PLUG



PART #	JG PART #	TUBE O.D.	BAG QTY
8J TP380BP	PP0812E	3/8"	10

PART FC - FEMALE CONNECTOR



PART #	JG PART #	TUBE O.D.	THREAD NPTF	BAG QTY
8J FC140180NPTBP	PP450821E	1/4"	1/8"	10
8J FC140140NPTBP	PP450822E	1/4"	1/4"	10

PART BUC - BULKHEAD UNION CONNECTOR



PART #	JG PART #	TUBE O.D.	MOUNTING HOLE	BAG QTY
8J BUC140BP	PP1208E	1/4"	0.67"	10
8J BUC380BP	PP1212E	3/8"	0.83"	10

John Guest Polypropylene Push Connect Fittings – Black

PRICING CODE | 8J



PART 2WDC - TWO-WAY DIVIDER CONNECTOR



PART #	JG PART #	TUBE O.D.	BAG QTY
8J 2WDC140BP	PP2308E	1/4"	10

PART TEC - TUBE STEM PLUG IN ELBOW CONNECTOR



PART #	JG PART #	STEM O.D.	TUBE O.D.	BAG QTY
8J TEC140140BP	PP220808E	1/4"	1/4"	10
8J TEC380140BP	PP221208E	3/8"	1/4"	10
8J TEC380380BP	PP221212E	3/8"	3/8"	10
8J TEC120120BP	PP221616E	1/2"	1/2"	10

PART TRC - STEM REDUCER CONNECTOR



PART #	JG PART #	STEM O.D.	TUBE O.D.	BAG QTY
8J TRC580380BP	PP062012E	5/8"	3/8"	10

PART HCP - HALF CARTRIDGE - PLASTIC BODY



PART #	JG PART #	TUBE O.D.	BAG QTY
8J HCP140BP	PP2808E	1/4"	10
8J HCP380BP	PP2812E	3/8"	10

PART CV - CHECK VALVE



PART #	JG PART #	TUBE O.D.	BAG QTY
8J CV140BP	NC2718E	1/4"	10

* Cracking Pressure: 5 lbs.

John Guest Black Polypropylene Service & Repair Kit

PRICING CODE **8J**



KIT DIMENSIONS:

Width	Depth	Height
15"	11-1/2"	2-1/2"

PART #	DESCRIPTION	QTY
PP010822E	NPT MALE CONNECTOR 1/4" X 1/4"	5
PP010823E	NPT MALE CONNECTOR 1/4" X 3/8"	5
PP011222E	NPT MALE CONNECTOR 3/8" X 1/4"	5
PP011223E	NPT MALE CONNECTOR 3/8" X 3/8"	5
PP0208E	UNION TEE 1/4"	5
PP0212E	UNION TEE 3/8"	5
PP0308E	UNION ELBOW 1/4"	5
PP0312E	UNION ELBOW 3/8"	5
PP0408E	UNION CONNECTOR 1/4"	5
PP0412E	UNION CONNECTOR 3/8"	5
PP050822E	NPT STEM ADAPTER 1/4" X 1/4"	5
PP051223E	NPTF STEM ADAPTER 3/8" X 3/8"	5
PP201208E	REDUCING UNION CONNECTOR 3/8" - 1/4"	5
PP201612E	REDUCING UNION CONNECTOR 1/2" - 3/8"	5
PP220808E	PLUG-IN ELBOW 1/4" X 1/4"	5
PP221212E	PLUG-IN ELBOW 3/8" X 3/8"	5
PP450822E	NPT FEMALE ADAPTER 1/4" X 1/4"	5
PP480822E	NPT FIXED ELBOW 1/4" X 1/4"	5
PP481222E	NPT FIXED ELBOW 3/8" X 1/4"	5
PP481223E	NPT FIXED ELBOW 3/8" X 3/8"	5
TSNIP	TUBE CUTTER	1
TOTAL		101

John Guest Ag Liquid Equipment Repair Kit

PRICING CODE **8J**

BLACK POLYPROPYLENE PUSH-CONNECT FITTINGS FOR LIQUID APPLICATIONS

	PART #	DESCRIPTION	QTY
	8J UTC140BP	TEE CONNECTOR 1/4" OD	4
	8J UC140BP	UNION CONNECTER 1/4" OD	7
	8J ME140140BP	MALE ELBOW 1/4" OD x 1/4" MPT	7
	8J RLC380140BP	REDUCING ELBOW 3/8" OD x 1/4" OD	5
	8J MC140140BP	MALE CONNECTOR 1/4" OD x 1/4" MPT	10
	8J MT140180BP	MALE STEM ADAPTER 1/4" TUBE x 1/8" MPT	4
	8J 2WDC140BP	TWO-WAY DIVIDER 1/4" OD	2
	8J MT140140BP	MALE STEM ADAPTER 1/4" TUBE x 1/4" MPT	10
	8J M50	M50 TUBE CUTTER	1
	8J ULC380BP	ELBOW CONNECTOR 3/8" OD	4
	8J MC380140BP	MALE CONNECTOR 3/8" OD x 1/4" MPT	5
	8J ULC140BP	ELBOW CONNECTOR 1/4" OD	7
	8J MC140380BP	MALE CONNECTOR 1/4" OD x 3/8" MPT	4
	8J UTC380BP	TEE CONNECTOR 3/8" OD	3
	8J RUC380140BP	REDUCING UNION 3/8" OD x 1/4" OD	5
	8J UC380BP	UNION CONNECTER 3/8" OD	4
	8J MC38038BP	MALE CONNECTOR 3/8" OD x 3/8" MPT	5
	8J ME140180BP	MALE ELBOW 1/4" OD x 1/8" MPT	9
	TOTAL	96	

KIT DIMENSIONS:

Width	Depth	Height
11"	7-1/4"	1-3/4"

CUSTOMIZED WITH YOUR LOGO

Your Logo - We can customize kits with your logo on both the inside and outside cover, driving customers back to your business.

Your Preferred Fittings - We can modify kit configurations to meet your requirements. Let us know which Push-Connect fittings you prefer!

John Guest Speedfit Plumbing Fittings – White

PRICING CODE | 8J-PF



The PEI Range of Twist & Lock Fittings is offered in 1/2" - 1" CTS sizes. They have been specifically designed for Plumbing and Water Filtration/Softener Installs. However, they are also suitable for Marine and R.V. applications. The fittings are manufactured from high quality engineered plastic with EPDM O-rings and are suitable for hot and cold water plumbing applications.

For use with Copper, PEX, and CPVC Pipe

TEE



PART #	JG PART #	SIZE CTS	BAG QTY
8J PFUTC380	PSEI0216	3/8"	5
8J PFUTC120	PEI0220	1/2"	5
8J PFUTC340	PEI0228	3/4"	2
8J PFUTC1000	PEI0236	1"	1

REDUCING TEE



PART #	JG PART #	SIZE CTS	BAG QTY
8J PFUTCR340340120	PEI3028A	3/4" X 3/4" X 1/2"	5
8J PFUTCR340120120	PEI3028B	3/4" X 3/4" X 1/2"	5
8J PFUTCR120120340	PEI3028C	1/2" X 1/2" X 3/4"	5
8J PFUTCR340120340	PEI3028D	3/4" X 1/2" X 3/4"	5
8J PFUTCR100100340	PEI3036A	1" X 1" X 3/4"	1

STACKABLE TEE



PART #	JG PART #	SIZE CTS	BAG QTY
8J PFST120120120	PEI532020	1/2" X 1/2" X 1/2"	5
8J PFST340340120	PEI532820	3/4" X 3/4" X 1/2"	5
8J PFST340340340	PEI532828	3/4" X 3/4" X 3/4"	1

John Guest Speedfit Plumbing Fittings – White

PRICING CODE | 8J-PF



ELBOW



PART #	JG PART #	SIZE CTS	BAG QTY
8J PFULC380	PSEI0316	3/8"	10
8J PFULC120	PEI0320	1/2"	5
8J PFULC340	PEI0328	3/4"	5
8J PFULC1000	PEI0336	1"	1

REDUCING ELBOW



PART #	JG PART #	SIZE CTS	BAG QTY
8J PFRLC340120	PEI212820	3/4" X 1/2"	5
8J PFRLC100340	PEI213628	1" X 3/4"	1

COUPLER



PART #	JG PART #	SIZE CTS	BAG QTY
8J PFUC380	PSEI0416	3/8"	10
8J PFUC120	PEI0420	1/2"	5
8J PFUC340	PEI0428	3/4"	5
8J PFUC1000	PEI0436	1"	1

REDUCING COUPLER



PART #	JG PART #	SIZE CTS	BAG QTY
8J PFRUC120380	PSEI202016	1/2" X 3/8"	10
8J PFRUC340120	PEI202820	3/4 X 1/2"	10
8J PFRUC100340	PEI203628	1" X 3/4"	5

JG John Guest Speedfit Plumbing Fittings – White

PRICING CODE | **8J-PF**



STEM ELBOW



PART #	JG PART #	SIZE STEM X CTS	BAG QTY
8J PFTEC120120	PEI222020	1/2" X 1/2"	10
8J PFTEC340340	PEI222828	3/4" X 3/4"	5

MALE FIXED ELBOW



PART #	JG PART #	SIZE CTS X NPT	BAG QTY
8J PFME120120	PSEI482024	1/2" X 1/2"	5

MALE CONNECTOR



PART #	JG PART #	SIZE CTS X NPT	BAG QTY
8J PFMC380120	PSEI011624	3/8" X 1/2"	10
8J PFMC120120	PSEI012024	1/2" X 1/2"	10
8J PFMC120340	PSEI012026	1/2" X 3/4"	5
8J PFMC340340	PSEI012826	3/4" X 3/4"	5
8J PFMC100340	PSEI013626	1" X 3/4"	2
8J PFMC100100	PSEI013628	1" X 1"	2

REDUCER



PART #	JG PART #	SIZE STEM X CTS	BAG QTY
8J TRC580140WP	PP062008W	5/8" X 1/4"	10
8J TRC580380WP	PP062012W	5/8" X 3/8"	10
8J TRC580120WP	PP062016W	5/8" X 1/2"	10
8J PFTRC120380	PSEI062016P	1/2" X 3/8"	1
8J PFTRC340120	PEI062820	3/4" X 1/2"	10
8J PFTRC100340	PEI063628	1" X 3/4"	5

John Guest Speedfit Plumbing Fittings – White

PRICING CODE | 8J-PF



END CAP



PART #	JG PART #	SIZE CTS	BAG QTY
8J PFEC120	PSEI4620	1/2"	10
8J PFEC120B*	PSEI4620B	1/2"	10
8J PFEC120R**	PSEI4620R	1/2"	10
8J PFEC340	PSEI4628	3/4"	5
8J PFEC340B*	PSEI4628B	3/4"	5
8J PFEC340R**	PSEI4628R	3/4"	5
8J PFEC1000	PSEI4636	1"	5

*Color available in Blue
 **Color available in Red

FEMALE SWIVEL CONNECTOR



PART #	JG PART #	SIZE CTS X NPS	BAG QTY
8J PFFSC120	PEISTC2034	1/2" X 1/2"	10

FEMALE COUPLER TAB CONNECTOR



PART #	JG PART #	TUBE O.D.	THREAD BSP	BAG QTY
8J PFFC15MMX120BSP	PSE3201W	15	1/2"	10

FEMALE SWIVEL ELBOW



PART #	JG PART #	SIZE CTS X NPS	BAG QTY
8J PFFSE120	PEIBTC2034	1/2" X 1/2"	10

John Guest Speedfit Plumbing Fittings – White

PRICING CODE | 8J-PF



PIPE INSERT



PART #	JG PART #	SIZE CTS	BAG QTY
8J PFTSI120	TSI20P	1/2"	10
8J PFTSI340	TSI28P	3/4"	5

FEMALE CONNECTOR



PART #	JG PART #	SIZE CTS X NPS	BAG QTY
8J PFFC120120	PEI452034	1/2" X 1/2"	5
8J PFFC340340	PSEI452826	3/4" X 3/4"	5

BRASS MALE CONNECTOR



PART #	JG PART #	SIZE CTS X NPT	BAG QTY
8J PFBMCLF120120	MWI012024LF	1/2" X 1/2"	5
8J PFBMCLF120340	MWI012026LF	1/2" X 3/4"	5
8J PFBMCLF340340	MWI012826LF	3/4" X 3/4"	5

BRASS MALE STEM ADAPTER



PART #	JG PART #	SIZE CTS X NPT	BAG QTY
8J PFBMTLF120120	MWI052024LF	1/2" X 1/2"	10
8J PFBMTLF340340	MWI052826LF	3/4" X 3/4"	5

John Guest Speedfit Plumbing Fittings – White

PRICING CODE | **8J-PF**



WING BACK ELBOW



PART #	JG PART #	SIZE CTS X NPT	BAG QTY
8J PFBDEE120120	WBI2024	1/2" X 1/2"	1

SHUT OFF VALVE



PART #	JG PART #	SIZE CTS	BAG QTY
6J PFPPV120120-GG	PSEISV20P	1/2"	1
6J PFPPV340340-GG	PSEISV28P	3/4"	1

STRAIGHT SHUT-OFF VALVES



PART #	JG PART #	SIZE CTS	BAG QTY
6J PFV120120-GG	NC2390	1/2"	1

BY-PASS VALVES



PART #	JG PART #	SIZE CTS	BAG QTY
6J PFV3WBP120RH	NC2391-RH	1/2"	1
6J PFV3WBP120LH	NC2391-LH	1/2"	1

John Guest Speedfit Plumbing Fittings – Black

PRICING CODE | 8J-PF



The Black PEI Range of Twist & Lock Fittings is offered in 1/2" - 1" CTS sizes. They have been specifically designed for Plumbing and Water Filtration/Softener Installs. However, they are also suitable for Marine and R.V. applications. The fittings are manufactured from high quality engineered plastic with EPDM O-rings and are suitable for hot and cold water plumbing applications.

For use with Copper, PEX, and CPVC Pipe

UNION COUPLER



PART #	JG PART #	SIZE CTS	BAG QTY
8J PLUC120E*	PSEI0420E	1/2"	10
8J PFUC340E	PEI0428E	3/4"	5
8J PFUC1000E	PEI0436E	1"	1

ELBOW



PART #	JG PART #	SIZE CTS	BAG QTY
8J PLULC120E*	PSEI0320E	1/2"	10
8J PFULC340E	PEI0328E	3/4"	5
8J PFULC1000E	PEI0336E	1"	1

TEE



PART #	JG PART #	SIZE CTS	BAG QTY
8J PLUTC120E*	PSEI0220E	1/2"	5
8J PFUTC340E	PEI0228E	3/4"	2
8J PFUTC1000E	PEI0236E	1"	1

PLUG IN ELBOW



PART #	JG PART #	SIZE CTS X STEM	BAG QTY
8J PFTEC340340E	PEI222828E	3/4" X 3/4"	5
8J PFTEC10001000E	PEI223636E	1" X 1"	1

**Available in John Guest ProLock Plumbing Fittings*

John Guest Speedfit Plumbing Fittings – Black

PRICING CODE | 8J-PF



MALE CONNECTOR



PART #	JG PART #	SIZE CTS X NPT	BAG QTY
8J PLMC120120E*	PSEI012024E	1/2" X 1/2"	10
8J PLMC120340E*	PSEI012026E	1/2" X 3/4"	5
8J PLMC340340E*	PSEI012826E	3/4" X 3/4"	5
8J PLMC340100E*	PSEI012828E	3/4" X 1"	5
8J PLMC100340E*	PSEI013626E	1" X 3/4"	2
8J PLMC10001000E*	PSEI013628E	1" X 1"	2

MALE STEM ADAPTER



PART #	JG PART #	SIZE CTS X NPT	BAG QTY
8J PLMT340340E*	PSEI052826E	3/4" X 3/4"	10
8J PLMT1000E*	PSEI053628E	1" X 1"	10

SHUT-OFF VALVE



PART #	JG PART #	SIZE CTS	BAG QTY
6J PLV120120B-GG*	PSEISV20EP	1/2" X 1/2"	1
6J PLV340340B-GG*	PSEISV28EP	3/4" X 3/4"	1

MALE FIXED ELBOW



PART #	JG PART #	SIZE CTS X NPT	BAG QTY
8J PLME120120E*	PSEI482024E	1/2" X 1/2"	5

*Available in John Guest ProLock Plumbing Fittings

John Guest Speedfit Plumbing Fittings – Black

PRICING CODE | 8J-PF



FEMALE CONNECTOR



PART #	JG PART #	SIZE CTS X NPS	BAG QTY
8J PLFC120340E*	PSEI622036E-L	1/2" X 3/4"	2
8J PLFC340340E*	PSEI622836E-L	3/4" X 3/4"	2
8J PLFC340100E*	PSEI622838E-L	3/4" X 1"	2
8J PLFC100100E*	PSEI623638E-L	1" X 1"	2
8J PLFC100125E*	PSEI62363AE-L	1" X 1-1/4"	1

FEMALE ELBOW CONNECTOR



PART #	JG PART #	SIZE CTS X NPS	BAG QTY
8J PLFE340340E*	PSEI632836E-L	3/4" X 3/4"	2
8J PLFE340100E*	PSEI632838E-L	3/4" X 1"	2
8J PLFE340125E*	PSEI63283AE-L	3/4" X 1-1/4"	1
8J PLFE100125E*	PSEI63363AE-L	1" X 1-1/4"	1

REDUCING COUPLER



PART #	JG PART #	SIZE CTS	BAG QTY
8J PFRUC100340E	PEI203628E	1" X 3/4"	5

*Available in John Guest ProLock Plumbing Fittings

**THIS PAGE IS
INTENTIONALLY
LEFT BLANK**

John Guest ProLock Plumbing Fittings

PRICING CODE | 8J-PL



JG ProLock™ fittings have a collet with stainless steel teeth that grip the pipe when fully inserted, and an o-ring to provide a permanent, leak-proof seal. When twisted into place, the locking cap locks the pipe in place, ensuring maximum security. No tools, soldering, clamps or glue are ever required.

"The range of ProLock Twist-to-Lock fittings is offered in 1/2" to 1" CTS sizes. They have been specifically designed for the Professional Plumber. The fittings are manufactured from high quality engineered plastic with EPDM O-Rings. ProLock Twist-to-Lock fittings are suitable for hot and cold water plumbing applications."

Max Pressure: 160 psi at 73°F.

For use with Copper, PEX, and CPVC Pipe

TEE



PART #	JG PART #	SIZE CTS	BAG QTY
8J PLUTC120E	PSEI0220E	1/2"	5
8J PLUTC340E	PSEI0228E	3/4"	5
8J PLUTC1000E	PSEI0236E	1"	1

ELBOW



PART #	JG PART #	SIZE CTS	BAG QTY
8J PLULC120E	PSEI0320E	1/2"	10
8J PLULC340E	PSEI0328E	3/4"	5
8J PLULC1000E	PSEI0336E	1"	5

COUPLER



PART #	JG PART #	SIZE CTS	BAG QTY
8J PLUC120E	PSEI0420E	1/2"	10
8J PLUC340E	PSEI0428E	3/4"	5
8J PLUC1000E	PSEI0436E	1"	5

John Guest ProLock Plumbing Fittings

PRICING CODE | 8J-PL



REDUCING COUPLER



PART #	JG PART #	SIZE CTS	BAG QTY
8J PLRUC1000340E	PSEI203628E	1" X 3/4"	5

PLUG-IN ELBOW



PART #	JG PART #	SIZE STEM X CTS	BAG QTY
8J PLTEC340340E	PSEI222828E	3/4" X 3/4"	5
8J PLTEC100100E	PSEI223636E	1" X 1"	5

MALE CONNECTOR NPT THREADS



PART #	JG PART #	SIZE CTS X NPT	BAG QTY
8J PLMC120120E	PSEI012024E	1/2" X 1/2"	10
8J PLMC120340E	PSEI012026E	1/2" X 3/4"	5
8J PLMC340340E	PSEI012826E	3/4" X 3/4"	5
8J PLMC3401000E	PSEI012828E	3/4" X 1"	5
8J PLMC1000340E	PSEI013626E	1" X 3/4"	2
8J PLMC10001000E	PSEI013628E	1" X 1"	2

MALE STEM ADAPTER NPT THREADS



PART #	JG PART #	SIZE CTS X NPT	BAG QTY
8J PLMT340340E	PSEI052826E	3/4" X 3/4"	10
8J PLMT1000E	PSEI053628E	1" X 1"	10

John Guest ProLock Plumbing Fittings

PRICING CODE | 8J-PL



SHUT-OFF VALVE



PART #	JG PART #	SIZE CTS	BAG QTY
6J PLV120120B-GG	PSEISV20EP	1/2" X 1/2"	1
6J PLV340340B-GG	PSEISV28EP	3/4" X 3/4"	1

MALE FIXED ELBOW NPT THREADS



PART #	JG PART #	SIZE CTS X NPT	BAG QTY
8J PLME120120E	PSEI482024E	1/2" X 1/2"	5

FEMALE ELBOW CONNECTOR NPS THREADS



PART #	JG PART #	SIZE CTS X NPS	BAG QTY
8J PLFE340340E	PSEI632836E-L	3/4" X 3/4"	2
8J PLFE3401000E	PSEI632838E-L	3/4" X 1"	2
8J PLFE3401250E	PSEI63283AE-L	3/4" X 1-1/4"	1
8J PLFE1001250E	PSEI63363AE-L	1" X 1-1/4"	1

FEMALE CONNECTOR NPS TREADS



PART #	JG PART #	SIZE CTS X NPS	BAG QTY
8J PLFC120340E	PSEI622036E-L	1/2" X 3/4"	2
8J PLFC340340E	PSEI622836E-L	3/4" X 3/4"	2
8J PLFC3401000E	PSEI622838E-L	3/4" X 1"	2
8J PLFC10001000E	PSEI623638E-L	1" X 1"	2
8J PLFC10001250E	PSEI62363AE-L	1" X 1-1/4"	1

**THIS PAGE IS
INTENTIONALLY
LEFT BLANK**





SharkBite® Brass Plumbing Fittings

PRICING CODE | **8J-SB**

The SharkBite system includes a wide range of plumbing fittings, valves, PEX pipe, outlet boxes and other plumbing accessories, making it the only system that is a total end-to-end plumbing solution from meter to fixture. This means compatibility and peace of mind quality that is backed by a single manufacturer.

FEATURES:

- Lead-Free - All SharkBite fittings are made from Lead Free DZR brass
- Versatile: Compatible with copper, PEX, CPVC, PE-RT, HDPE, Polybutylene, and PVC piping.
- Flexibility: Can be rotated after assembly allowing for easier installation in tight spaces
- Behind-the-Wall: Approved to be used underground and behind walls without access panels
- Max Pressure: 200psi
- Certified to NSF/ANSI 61 and ASSE 1061 product standards for use in potable water and hydronic heating water distribution

PRODUCT	PART #	SB PART #	DESCRIPTION	BAG QTY
<p>COUPLINGS</p> 	8SB UC140	U004LF	1/4" (3/8" OD) X 1/4" (3/8" OD)	6
	8SB UC380	U006LF	3/8" (1/2" OD) X 3/8" (1/2" OD)	6
	8SB UC120	U008LF	1/2" X 1/2"	12
	8SB UC340	U016LF	3/4" X 3/4"	12
	8SB UC100	U020LF	1" X 1"	6
<p>REDUCING COUPLINGS</p> 	8SB RUC120140	U050LF	1/4" (3/8" OD) X 1/2"	6
	8SB RUC120380	U009LF	3/8" (1/2" OD) X 1/2"	6
	8SB RUC340120	U058LF	3/4" X 1/2"	12
	8SB RUC100340	U060LF	1" X 3/4"	6
<p>SLIP COUPLINGS</p> 	<p>(SLIP END ONLY SUITABLE FOR COPPER AND CPVC)</p> <p>Slip couplings are the most efficient way to repair a burst pipe or leak. Slip fittings simply repair by doing the job that two couplings and extra pipe used to do. Only one end of the coupling has a stop, allowing the opposite end to slide freely over the end of a pipe. The fittings can then be released with a disconnect tool and slid back onto the other end of the pipe for a successful connection and leak repair.</p>			
	8SB SC120	U3008LF	1/2" X 1/2"	3
	8SB SC340	U3016LF	3/4" X 3/4"	3
	8SB SC100	U3020LF	1" X 1"	1



SharkBite® Brass Plumbing Fittings

PRICING CODE | **8J-SB**

PRODUCT	PART #	SB PART #	DESCRIPTION	BAG QTY
<p>FEMALE CONNECTORS</p> 	8SB FC140120FNPT	U066LF	1/4" (3/8" OD) X 1/2" FNPT Reducing	6
	8SB FC380120FNPT	U070LF	3/8" (1/2" OD) X 1/2" FNPT Reducing	6
	8SB FC120120FNPT	U072LF	1/2" X 1/2" FNPT Straight	12
	8SB FC120340FNPT	U068LF	1/2" X 3/4" FNPT Reducing	6
	8SB FC340340FNPT	U088LF	3/4" X 3/4" FNPT Straight	6
	8SB FC100100FNPT	U094LF	1" X 1" FNPT Straight	6
<p>MALE CONNECTORS</p> 	8SB MC140120	U110LF	1/4" X 1/2" MNPT Reducing	6
	8SB MC380120	U118LF	3/8" (1/2" OD) X 1/2" MNPT Reducing	6
	8SB MC120120	U120LF	1/2" X 1/2" MNPT Straight	12
	8SB MC120340	U116LF	1/2" X 3/4" MNPT Reducing	6
	8SB MC340120BN	U138LF	3/4" X 1/2" MNPT Bullnose	12
	8SB MC340340	U134LF	3/4" X 3/4" MNPT Straight	12
	8SB MC340100	U139LF	3/4" X 1" MNPT Straight	6
	8SB MC100340	U142LF	1" X 3/4" MNPT Reducing	6
	8SB MC100100	U140LF	1" X 1" MNPT Straight	6
<p>SLIP MALE CONNECTORS</p> 	8SB SMC120120	U3120LF	1/2" x 1/2" MNPT	6
	8SB SMC340340	U3134LF	3/4" x 3/4" MNPT	6
	8SB SMC100100	U3140LF	1" x 1" MNPT	6

SharkBite® Brass Plumbing Fittings

PRICING CODE | 8J-SB

PRODUCT	PART #	SB PART #	DESCRIPTION	BAG QTY
THREADED ADAPTERS 	8SB FT340340	U766LF	3/4" CTS X 3/4" FNPT Threaded	6
	8SB FT100100	U772LF	1" CTS X 1" FNPT Threaded	6
90° ELBOWS 	8SB ULC140	U244LF	1/4" (3/8" OD) X 1/4" (3/8"OD)	6
	8SB ULC380	U246LF	3/8" (1/2"OD) X 3/8" (1/2"OD)	6
	8SB ULC120	U248LF	1/2" X 1/2"	12
	8SB ULC340	U256LF	3/4" X 3/4"	6
	8SB ULC100	U260LF	1" X 1"	6
45° ELBOWS 	8SB 45ULC120	U648LF	1/2" x 1/2"	12
	8SB 45ULC340	U656LF	3/4" x 3/4"	6
	8SB 45ULC100	U660LF	1" x 1"	12
45° STREET ELBOWS 	8SB 45TEC120	U615LF	1/2" x 1/2" CTS Tube Stem	6
	8SB 45TEC340	U620LF	3/4" x 3/4" CTS Tube Stem	6
FEMALE ELBOWS 	8SB FEC120120FNTP	U308LF	1/2" X 1/2" FNPT	6
	8SB FEC340340FNTP	U314LF	3/4" X 3/4 " FNPT	3



SharkBite® Brass Plumbing Fittings

PRICING CODE | **8J-SB**

PRODUCT	PART #	SB PART #	DESCRIPTION	BAG QTY
<p>MALE ELBOWS</p> 	8SB ME120120	U280LF	1/2" X 1/2" MNPT	6
	8SB ME340340	U286LF	3/4" X 3/4" MNPT	6
<p>REDUCING ELBOWS</p> 	8SB RLC120380	U272LF	1/2" X 3/8" (1/2"OD)	12
	8SB RLC340120	U274LF	3/4" X 1/2"	6
	8SB RLC100340	U278LF	1" X 3/4"	3
<p>DROP-EAR ELBOWS</p> 	8SB DELC380120FNPT	U332LF	3/8" (1/2" OD) X 1/2" FNPT	6
	8SB DELC120120	U249LF	1/2" X 1/2" CTS	12
	8SB DELC120120FNPT	U334LF	1/2" X 1/2" FNPT	6
	8SB DELC340340FNPT	U340LF	3/4" X 3/4" FNPT	6
<p>HY-EAR ELBOWS</p> 	8SB HYLC120120	U335LF	1/2" X 1/2" Hy-Ear	6
<p>DISHWASHER ELBOWS</p> 	8SB DWLC140380MNPT	U276LF	1/4" (3/8" OD) X 3/8" MNPT	6
	8SB DWLC140340GHN	U2276LF	1/4" (3/8" OD) X 3/4" Garden Hose Nut	6
	8SB DWLC120380MNPT	U281LF	1/2" X 3/8" MNPT	6



SharkBite® Brass Plumbing Fittings

PRICING CODE | 8J-SB

PRODUCT	PART #	SB PART #	DESCRIPTION	BAG QTY
<p>TEES</p> 	8SB UTC140	U358LF	1/4" (3/8" OD) X 1/4" (3/8" OD) X 1/4" (3/8" OD)	6
	8SB UTC380	U360LF	3/8" (1/2" OD) X 3/8" (1/2" OD) X 3/8" (1/2" OD)	6
	8SB UTC120	U362LF	1/2" X 1/2" X 1/2"	12
	8SB UTC340	U370LF	3/4" X 3/4" X 3/4"	6
	8SB UTC100	U374LF	1" X 1" X 1"	3
<p>REDUCING TEES</p> 	8SB UTCR380120	U364LF	3/8" (1/2" OD) X 3/8" (1/2" OD) X 1/2"	6
	8SB UTCR120140	U359LF	1/2" X 1/2" X 1/4" (3/8" OD)	6
	8SB UTCR120380	U363LF	1/2" X 1/2" X 3/8" (1/2" OD)	6
	8SB UTCR340120120	U454LF	3/4" X 1/2" X 1/2"	6
	8SB UTCR340120	U412LF	3/4" X 3/4" X 1/2"	6
	8SB UTCR340120340	U444LF	3/4" X 1/2" X 3/4"	6
	8SB UTCR100340	U416LF	1" X 1" X 3/4"	3
<p>FEMALE CENTER TEES</p> 	8SB FCUTC340	U462LF	3/4" x 3/4" x 3/4"	3
	8SB FCUTC100	U464LF	1" x 1" x 1"	3



SharkBite® Brass Plumbing Fittings



PRICING CODE | **8J-SB**

PRODUCT	PART #	SB PART #	DESCRIPTION	BAG QTY
FEMALE CENTER SLIP TEES 	(SLIP END ONLY SUITABLE FOR COPPER AND CPVC)			
	8SB FCSUTC120	U3482LF	1/2" X 1/2" X 1/2" FNPT	3
	8SB FCSUTC340	U3486LF	3/4" X 3/4" X 3/4" FNPT	3
SLIPTEES 	(SLIP END ONLY SUITABLE FOR COPPER AND CPVC)			
	8SB SUTC120	U3362LF	1/2" X 1/2" X 1/2"	3
	8SB SUTC340	U3370LF	3/4" X 3/4" X 3/4"	3
SERVICE SLIP TEE ADAPTER 	(SLIP END ONLY SUITABLE FOR COPPER AND CPVC)			
	8SB UTCSB120	U4482LF	1/2" X 1/2" X 1/2" CTS Tail Adapter Service Line Tee	6
END CAPS 	8SB CAP380	U512LF	3/8" (1/2" OD)	6
	8SB CAP120	U514LF	1/2"	12
	8SB CAP340	U518LF	3/4"	6
	8SB CAP100	U520LF	1"	6





SharkBite® Brass Plumbing Fittings

PRICING CODE | **8J-SB**

PRODUCT	PART #	SB PART #	DESCRIPTION	BAG QTY
FITTING REDUCERS	(USE TO CONNECT TO SMALLER PIPE SIZES)			
	8SB TRC120380	U719LF	3/8" (1/2" OD) X 1/2" Tube Stem	6
	8SB TRC340380	U721LF	3/8" (1/2" OD) X 3/4" Tube Stem	6
	8SB TRC100120	U722LF	1/2" X 1" Tube Stem	6
	8SB TRC100340	U724LF	3/4" X 1" Tube Stem	6
WATER SOFTENER FITTING				
	8SB WSF340100FIP	U086LF	3/4" X 1" FIP	12



PRICING CODE | 8J-SB

PRODUCT	DESCRIPTION	PART #	SB PART #	BAG QTY
<p>DEBURR & GAUGE TOOLS</p> 	Use for 1/4", 3/8", 1/2", 5/8", 3/4" and 1" copper and CPVC pipe	8SB DGT	U702	1
<p>DISCONNECT CLIPS</p> 	1/4"	8SB DC140	U706	12
	3/8"	8SB DC380	U708	24
	1/2"	8SB DC120	U710	24
	5/8"	8SB DC580	U3712	24
	3/4"	8SB DC340	U712	24
	1"	8SB DC100	U714	12
<p>DISCONNECT TONGS</p> 	1/2"	8SB DT120	U711	1
	3/4"	8SB DT340	U713	1
	1"	8SB DT100	U715	1

SeaTech / AquaLock™ Plumbing Fittings

PRICING CODE **8S**

FEATURES:

- No tools required—connect and disconnect without tools for easy and flexible installation.
- Locking clip—for extra connection security.
- NO flow restriction—no pipe stiffeners for copper and CPVC pipes allows for full flow without additional head losses.
- Rotate under pressure—for Brass, Mini, and Plastic fittings.
- Zero-leak patented O-ring guide for Plastic Series—protects the O-ring from damage during connection, helps align the tubing with the O-ring every time, and prevents the O-ring from becoming dislodged.

MALE THREAD CONNECTOR



PART #	SIZE CTS X NPT	BAG QTY
8S 3501-0806	3/8" X 3/8"	5
8S 3501-0808	3/8" X 1/2"	5
8S 3501-1006	1/2" X 3/8"	5
8S 3501-1008	1/2" X 1/2 "	5
8S 3501-1012	1/2" X 3/4"	5
8S 3501-1014	1/2" X 3/4" (MGHT)	5
8S 3501-1412	3/4" X 3/4"	5

FEMALE SWIVEL CONNECTOR



PART #	SIZE CTS X NPS	BAG QTY
8S 3510-0808	3/8" X 1/2"	5
8S 3510-1008	1/2" X 1/2"	5
8S 3510-1012	1/2" X 3/4"	5
8S 3510-1013	1/2" X 3/4" (CLOSET)	5
8S 3510-1014	1/2" X 3/4" (FGHT)	5
8S 3510-1412	3/4" X 3/4"	5
8S 3510-1816	1" X 1"	5

STACKABLE HOSE BARB UNION



PART #	SIZE CTS X HB	BAG QTY
8S 3511-1008	1/2" X 1/2"	6

SeaTech / AquaLock™ Plumbing Fittings

PRICING CODE

8S

STACKABLE HOSE BARB ELBOW



PART #	SIZE CTS X HB	BAG QTY
8S 3512-1008	1/2" X 1/2"	5

HOSE BARB FITTING



PART #	SIZE CTS X HB	BAG QTY
8S 3513-1008	1/2" X 1/2"	5
8S 3513-1412	3/4" X 3/4"	5
8S 3513-1816	1" X 1"	5

REDUCING STEM



PART #	SIZE CTS X CTS	BAG QTY
8S 3514-1008	1/2" X 3/8"	5
8S 3514-1410	3/4" X 1/2"	5
8S 3514-1810	1" X 1/2"	5
8S 3514-1814	1" X 3/4"	5

UNION CONNECTOR



PART #	SIZE CTS	BAG QTY
8S 3515-08	3/8"	5
8S 3515-10	1/2"	5
8S 3515-14	3/4"	5
8S 3515-18	1"	5

SeaTech / AquaLock™ Plumbing Fittings

PRICING CODE | 8S

REDUCING UNION



PART #	SIZE CTS X CTS	BAG QTY
8S 3515R-1004	1/2" X 1/4" (OD)	5
8S 3515R-1008	1/2" X 3/8"	5
8S 3515R-1410	3/4" X 1/2"	5
8S 3515R-1814	1" X 3/4"	5

UNION ELBOW



PART #	SIZE CTS	BAG QTY
8S 3517-08	3/8"	5
8S 3517-10	1/2"	5
8S 3517-14	3/4"	5
8S 3517-18	1"	5

STACKABLE ELBOW



PART #	SIZE CTS	BAG QTY
8S 3518-08	3/8"	5
8S 3518-10	1/2"	5
8S 3518-14	3/4"	5
8S 3518-18	1"	5

MALE THREAD ELBOW



PART #	SIZE CTS X NPT	BAG QTY
8S 3519-1006	1/2" X 3/8"	5
8S 3519-1008	1/2" X 1/2"	5
8S 3519-1816	1" X 1"	5

SeaTech / AquaLock™ Plumbing Fittings

PRICING CODE **8S**

FEMALE SWIVEL ELBOW



PART #	SIZE CTS X NPS	BAG QTY
8S 3520-0808	3/8" X 1/2"	5
8S 3520-1008	1/2" X 1/2"	5
8S 3520-1012	1/2" X 3/4"	5
8S 3520-1013	1/2" X 3/4" (CLOSET)	5
8S 3520-1014	1/2" X 3/4" (FGHT)	5

DROP EAR ELBOW



PART #	SIZE CTS X NPT	BAG QTY
8S 3521-1008	1/2" X 1/2"	5

UNION TEE



PART #	SIZE CTS	BAG QTY
8S 3523-08	3/8"	5
8S 3523-10	1/2"	5
8S 3523-14	3/4"	5
8S 3523-18	1"	5

MALE STEM (PLASTIC)



PART #	SIZE CTS X NPT	BAG QTY
8S 3527-1008	1/2" X 1/2"	5

FEMALE STEM (PLASTIC)



PART #	SIZE CTS X NPT	BAG QTY
8S 3528-1008	1/2" X 1/2"	5

SeaTech / AquaLock™ Plumbing Fittings

PRICING CODE

8S

MALE THREAD TEE



PART #	SIZE CTS X NPT	BAG QTY
8S 3530-1008	1/2" X 1/2"	5

STACKABLE TEE



PART #	SIZE CTS	BAG QTY
8S 3533-08	3/8"	5
8S 3533-10	1/2"	5
8S 3533-14	3/4"	5
8S 3533-18	1"	5

REDUCING STACKABLE TEE



PART #	SIZE CTS X CTS	BAG QTY
8S 3533R-1004	1/2" X 1/4" (OD)	5
8S 3533R-1410	3/4" X 1/2"	5

STACKABLE BRANCH TEE



PART #	SIZE CTS	BAG QTY
8S 3534-10	1/2"	5

END STOP



PART #	SIZE CTS	BAG QTY
8S 3545-08	3/8"	5
8S 3545-10	1/2"	5
8S 3545-14	3/4"	5
8S 3545-18	1"	5

SeaTech / AquaLock™ Plumbing Fittings

PRICING CODE | 8S

COLLET CLIP



PART #	SIZE CTS	BAG QTY
8S 3547-08	3/8"	5
8S 3547-10	1/2"	5
8S 3547-14	3/4"	5
8S 3547-18	1"	5

COLLET COVER



PART #	SIZE CTS	BAG QTY
8S 3555-10	1/2"	25
8S 3555-14	3/4"	25
8S 3555-18	1"	25

TUBE SUPPORT LINER



PART #	SIZE CTS	BAG QTY
8S 3560-08	3/8"	5
8S 3560-10	1/2"	5
8S 3560-14	3/4"	5
8S 3560-18	1"	5

UNION PUMP FITTING



PART #	SIZE CTS	BAG QTY
8S 3575-10	1/2"	10

ELBOW PUMP FITTING



PART #	SIZE CTS	BAG QTY
8S 3576-10	1/2"	24

Stainless Steel Push-in Fittings

PRICING CODE 7H

SPECIFICATIONS:

- Max Rating: 217 PSI
- Temperature: -4°F to +302°F
- Body: 316 Stainless Steel
- Release Ring: 316 Stainless Steel
- Tightness Ring: 316 Stainless Steel
- Gripping Collet: 301 Stainless Steel
- Protection Ring: 301 Stainless Steel
- Sealing O'Ring: Viton

UNION TEE



PART #	TUBE O.D.
7H H1164X4-SS	1/4"
7H H1164X6-SS	3/8"
7H H1164X8-SS	1/2"

UNION ELBOW



PART #	TUBE O.D.
7H H1165X4-SS	1/4"
7H H1165X6-SS	3/8"
7H H1165X8-SS	1/2"

UNION



PART #	TUBE O.D.
7H H1162X4-SS	1/4"
7H H1162X6-SS	3/8"
7H H1162X8-SS	1/2"

BULKHEAD UNION



PART #	TUBE O.D.
7H H1174X4-SS	1/4"
7H H1174X6-SS	3/8"
7H H1174X8-SS	1/2"

Stainless Steel Push-in Fittings

PRICING CODE | 7H

FEMALE STRAIGHT



PART #	TUBE O.D.	FEMALE NPT
7H H1166X4-SS	1/4"	1/8"
7H H1166X4X4-SS	1/4"	1/4"
7H H1166X6-SS	3/8"	1/4"
7H H1166X6X6-SS	3/8"	3/8"
7H H1166X8-SS	1/2"	3/8"

MALE SWIVEL ELBOW



PART #	TUBE O.D.	MALE NPT
7H H1169X4S-SS	1/4"	1/8"
7H H1169X4X4S-SS	1/4"	1/4"
7H H1169X6S-SS	3/8"	1/4"
7H H1169X6X6S-SS	3/8"	3/8"
7H H1169X8S-SS	1/2"	3/8"
7H H1169X8X8S-SS	1/2"	1/2"

MALE STRAIGHT



PART #	TUBE O.D.	MALE NPT
7H H1168x4-SS	1/4"	1/8"
7H H1168X4X4-SS	1/4"	1/4"
7H H1168X6-SS	3/8"	1/4"
7H H1168X6X6-SS	3/8"	3/8"
7H H1168X8-SS	1/2"	3/8"
7H H1168X8X8-SS	1/2"	1/2"

MALE SWIVEL TEE



PART #	TUBE O.D.	MALE NPT
7H H1172X4S-SS	1/4"	1/8"
7H H1172X4X4S-SS	1/4"	1/4"
7H H1172X6S-SS	3/8"	1/4"
7H H1172X6X6S-SS	3/8"	3/8"
7H H1172X8S-SS	1/2"	3/8"
7H H1172X8X8S-SS	1/2"	1/2"

Nickel-Plated Push-in Fittings

PRICING CODE | 7H

SPECIFICATIONS:

- Max Rating: 217 P.S.I
- Temperature: -4°F to +160°F
- Body: Brass - Nickel-Plated
- Release Collect: Brass - Nickel-Plated
- Tightness Ring: Acetal
- Gripping Collet: 301 Stainless Steel
- Guide Ring: Acetal
- Sealing O-Ring: Buna

UNION TEE



PART #	TUBE O.D.
7H H1164X4	1/4"
7H H1164X6	3/8"
7H H1164X8	1/2"

UNION ELBOW



PART #	TUBE O.D.
7H H1165X4	1/4"
7H H1165X6	3/8"
7H H1165X8	1/2"

UNION



PART #	TUBE O.D.
7H H1162X2	1/8"
7H H1162X4	1/4"
7H H1162X6	3/8"
7H H1162X8	1/2"

BULKHEAD UNION



PART #	TUBE O.D.
7H H1174X4	1/4"
7H H1174X6	3/8"
7H H1174X8	1/2"

Nickel-Plated Push-in Fittings

PRICING CODE **7H**

FEMALE STRAIGHT



PART #	TUBE O.D.	FEMALE NPT
7H H1166X4	1/4"	1/8"
7H H1166X4X4	1/4"	1/4"
7H H1166X6	3/8"	1/4"
7H H1166X6X6	3/8"	3/8"

MALE SWIVEL ELBOW



PART #	TUBE O.D.	MALE NPT
7H H1169X4S	1/4"	1/8"
7H H1169X4X4S	1/4"	1/4"
7H H1169X6S	3/8"	1/4"
7H H1169X6X6S	3/8"	3/8"
7H H1169X8X4S	1/2"	1/4"
7H H1169X8S	1/2"	3/8"
7H H1169X8X8S	1/2"	1/2"

MALE STRAIGHT



PART #	TUBE O.D.	MALE NPT
7H H1168X4	1/4"	1/8"
7H H1168X4X4	1/4"	1/4"
7H H1168X6	3/8"	1/4"
7H H1168X6X6	3/8"	3/8"
7H H1168X8X4	1/2"	1/4"
7H H1168X8	1/2"	3/8"
7H H1168X8X8	1/2"	1/2"

MALE SWIVEL TEE



PART #	TUBE O.D.	MALE NPT
7H H1172X4S	1/4"	1/8"
7H H1172X4X4S	1/4"	1/4"
7H H1172X6S	3/8"	1/4"
7H H1172X6X6S	3/8"	3/8"
7H H1172X8S	1/2"	3/8"
7H H1172X8X8S	1/2"	1/2"

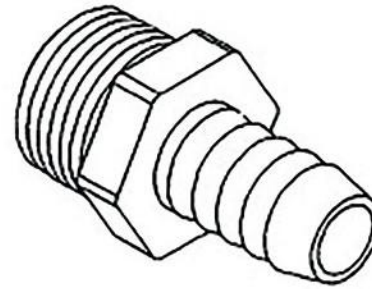

Plastic Hose Barb & Pipe Fittings

PRICING CODE		8A			
MPT	HB	NYLON	POLYPROPYLENE	POLYETHYLENE	
Our non-corrosive and 1/8"	1/5"	8A TA10-23N	8A TA10-23PP	8A TA10-23P	
	1/4"	8A TA10-24N	8A TA10-24PP	8A TA10-24P	
	1/3"	8A TA10-25N	8A TA10-25PP	8A TA10-25P	
	3/8"	8A TA10-26N	8A TA10-26PP	8A TA10-26P	
watertight and airtight connection 1/4"	1/5"	8A TA10-43N	8A TA10-43PP	8A TA10-43P	
	1/4"	8A TA10-44N	8A TA10-44PP	8A TA10-44P	
	1/3"	8A TA10-45N	8A TA10-45PP	8A TA10-45P	
	3/8"	8A TA10-46N	8A TA10-46PP	8A TA10-46P	
ADAPTERS MPT X HB 1/2"	1/2"	8A TA10-48N	8A TA10-48PP	8A TA10-48P	
	5/8"	8A TA10-410N	8A TA10-410PP	—	
	3/8"	1/4"	8A TA10-064N	8A TA10-064PP	8A TA10-64P
		1/3"	8A TA10-065N	8A TA10-065PP	8A TA10-65P
3/8"		8A TA10-066N	8A TA10-066PP	8A TA10-66P	
1/2"		8A TA10-068N	8A TA10-068PP	8A TA10-68P	
1/2"	5/8"	8A TA10-610N	8A TA10-610PP	8A TA10-610P	
	3/4"	8A TA10-612N	8A TA10-612PP	—	
	1/4"	8A TA10-084N	8A TA10-084PP	8A TA10-84P	
	3/8"	8A TA10-086N	8A TA10-086PP	8A TA10-86P	
	1/2"	8A TA10-088N	8A TA10-088PP	8A TA10-88P	
	1"	8A TA10-810N	8A TA10-810PP	8A TA10-810P	
1/2"	3/4"	8A TA10-812N	8A TA10-812PP	8A TA10-812P	
	1"	8A TA10-816N	8A TA10-816PP	—	

Continued on next page...

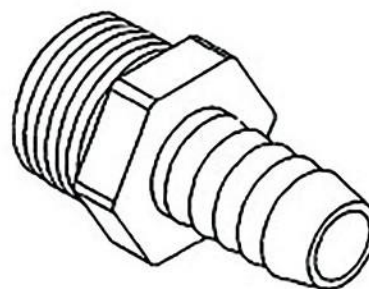

Plastic Hose Barb & Pipe Fittings

PRICING CODE		8A			
MPT	HB	NYLON	POLYPROPYLENE	POLYETHYLENE	
3/4"	1/4"	8A TA10-124N	8A TA10-124PP	8A TA10-124P	
	3/8"	8A TA10-126N	8A TA10-126PP	8A TA10-126P	
	1/2"	8A TA10-128N	8A TA10-128PP	8A TA10-128P	
	5/8"	8A TA10-1210N	8A TA10-1210PP	8A TA10-1210P	
	3/4"	8A TA10-1212N	8A TA10-1212PP	8A TA10-1212P	
	1"	8A TA10-1216N	8A TA10-1216PP	—	
	1-1/4"	8A TA10-1220N	8A TA10-1220PP	—	
1"	3/8"	8A TA10-0166N	8A TA10-0166PP	—	
	1/2"	8A TA10-0168N	8A TA10-0168PP	—	
	3/4"	8A TA10-1612N	8A TA10-1612PP	—	
	1"	8A TA10-1616N	8A TA10-1616PP	—	
	1-1/4"	8A TA10-1620N	8A TA10-1620PP	—	
1-1/4"	3/4"	8A TA10-2012N	8A TA10-2012PP	—	
	1"	8A TA10-2016N	8A TA10-2016PP	—	
	1-1/4"	8A TA10-2020N	8A TA10-2020PP	—	
	1-1/2"	8A TA10-2024N	8A TA10-2024PP	—	
1-1/2"	3/4"	8A TA10-2412N	8A TA10-2412PP	—	
	1"	8A TA10-2416N	8A TA10-2416PP	—	
	1-1/4"	8A TA10-2420N	8A TA10-2420PP	—	
	1-1/2"	8A TA10-2424N	8A TA10-2424PP	—	
	2"	8A TA10-2432N	8A TA10-2432PP	—	
2"	1-1/2"	8A TA10-3224N	8A TA10-3224PP	—	
	2"	8A TA10-3232N	8A TA10-3232PP	—	
3"	3"	—	8A TA10-4848PP	—	
4"	4"	—	8A TA10-6464PP	—	

Plastic Hose Barb & Pipe Fittings

PRICING CODE **8A**

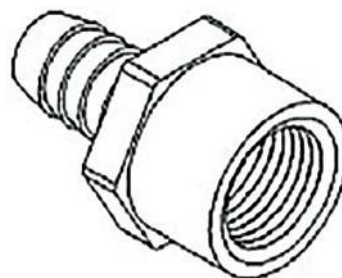

FEMALE ADAPTERS FPT X HB

FPT	HB	NYLON	POLYPROPYLENE
1/8"	1/4"	8A TAF10-24N	8A TAF10-24PP
	3/8"	8A TAF10-26N	8A TAF10-26PP
1/4"	1/4"	8A TAF10-44N	8A TAF10-44PP
	3/8"	8A TAF10-46N	8A TAF10-46PP
	1/2"	8A TAF10-48N	8A TAF10-48PP
3/8"	1/4"	8A TAF10-64N	8A TAF10-64PP
	3/8"	8A TAF10-66N	8A TAF10-66PP
	1/2"	8A TAF10-68N	8A TAF10-68PP
	5/8"	8A TAF10-610N	8A TAF10-610PP
	3/4"	8A TAF10-612N	8A TAF10-612PP
1/2"	1/4"	8A TAF10-84N	8A TAF10-84PP
	3/8"	8A TAF10-86N	8A TAF10-86PP
	1/2"	8A TAF10-88N	8A TAF10-88PP
	5/8"	8A TAF10-810N	8A TAF10-810PP
	3/4"	8A TAF10-812N	8A TAF10-812PP
3/4"	1/4"	8A TAF10-124N	8A TAF10-124PP
	3/8"	8A TAF10-126N	8A TAF10-126PP
	1/2"	8A TAF10-128N	8A TAF10-128PP
	5/8"	8A TAF10-1210N	8A TAF10-1210PP
	3/4"	8A TAF10-1212N	8A TAF10-1212PP
	1"	—	8A TAF10-1216PP
1"	1"	—	8A TAF10-1616PP

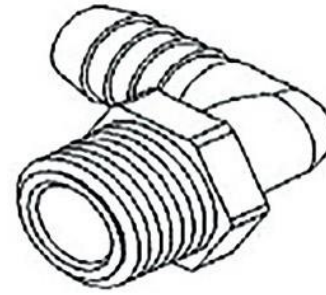

Plastic Hose Barb & Pipe Fittings

ELBOWS MPT X HB

PRICING CODE 8A

MPT	HB	NYLON	POLYPROPYLENE	POLYETHYLENE
1/8"	1/5"	8A TE20-23N	—	8A TE20-23P
	1/4"	8A TE20-24N	8A TE20-24PP	8A TE20-24P
	1/3"	8A TE20-25N	—	8A TE20-25P
	3/8"	8A TE20-26N	8A TE20-26PP	8A TE20-26P
1/4"	1/5"	8A TE20-43N	8A TE20-43PP	8A TE20-43P
	1/4"	8A TE20-44N	8A TE20-44PP	8A TE20-44P
	1/3"	8A TE20-45N	8A TE20-45PP	8A TE20-45P
	3/8"	8A TE20-46N	8A TE20-46PP	8A TE20-46P
	1/2"	8A TE20-48N	8A TE20-48PP	8A TE20-48P
	5/8"	8A TE20-410N	8A TE20-410PP	—
3/8"	1/4"	8A TE20-64N	8A TE20-64PP	8A TE20-64P
	1/3"	8A TE20-65N	8A TE20-65PP	8A TE20-65P
	3/8"	8A TE20-66N	8A TE20-66PP	8A TE20-66P
	1/2"	8A TE20-68N	8A TE20-68PP	8A TE20-68P
	5/8"	8A TE20-610N	8A TE20-610PP	8A TE20-610P
1/2"	1/4"	8A TE20-84N	8A TE20-84PP	8A TE20-84P
	3/8"	8A TE20-86N	8A TE20-86PP	8A TE20-86P
	1/2"	8A TE20-88N	8A TE20-88PP	8A TE20-88P
	5/8"	8A TE20-810N	8A TE20-810PP	8A TE20-810P
	3/4"	8A TE20-812N	8A TE20-812PP	8A TE20-812P
	1"	8A TE20-816N	8A TE20-816PP	8A TE20-816P

Continued on next page...

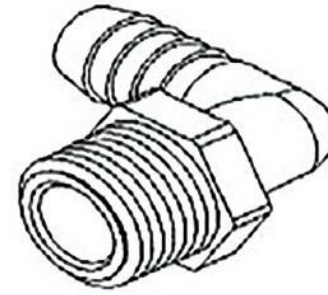

Plastic Hose Barb & Pipe Fittings

ELBOWS MPT X HB *continued*

PRICING CODE 8A

MPT	HB	NYLON	POLYPROPYLENE	POLYETHYLENE
3/4"	1/4"	8A TE20-124N	8A TE20-124PP	8A TE20-124P
	3/8"	8A TE20-126N	8A TE20-126PP	8A TE20-126P
	1/2"	8A TE20-128N	8A TE20-128PP	8A TE20-128P
	5/8"	8A TE20-1210N	8A TE20-1210PP	8A TE20-1210P
	3/4"	8A TE20-1212N	8A TE20-1212PP	—
	1"	8A TE20-1216N	8A TE20-1216PP	—
1"	1/2"	8A TE20-168N	8A TE20-168PP	—
	5/8"	8A TE20-1610N	8A TE20-1610PP	—
	3/4"	8A TE20-1612N	8A TE20-1612PP	8A TE20-1612P
	1"	8A TE20-1616N	8A TE20-1616PP	—
	1-1/4"	—	8A TE20-1620PP	—
1-1/4"	3/4"	8A TE20-2012N	8A TE20-2012PP	—
	1"	8A TE20-2016N	8A TE20-2016PP	—
	1-1/4"	8A TE20-2020N	8A TE20-2020PP	—
	1-1/2"	8A TE20-2024N	8A TE20-2024PP	—
1-1/2"	3/4"	8A TE20-2412N	8A TE20-2412PP	—
	1"	8A TE20-2416N	8A TE20-2416PP	—
	1-1/4"	8A TE20-2420N	8A TE20-2420PP	—
	1-1/2"	8A TE20-2424N	8A TE20-2424PP	—
2"	1-1/2"	—	8A TE20-3224PP	—
	2"	8A TE20-3232N	8A TE20-3232PP	—

Plastic Hose Barb & Pipe Fittings

PRICING CODE **8A**



ELBOWS FPT X HB

FPT	HB	NYLON	POLYPROPYLENE
1/8"	1/4"	8A TEF20-24N	8A TEF20-24PP
	1/3"	8A TEF20-26N	8A TEF20-26PP
1/4"	1/4"	8A TEF20-44N	8A TEF20-44PP
	3/8"	8A TEF20-46N	8A TEF20-46PP
3/8"	1/4"	8A TEF20-64N	8A TEF20-64PP
	3/8"	8A TEF20-66N	8A TEF20-66PP
	1/2"	8A TEF20-68N	8A TEF20-68PP
1/2"	1/4"	8A TEF20-84N	8A TEF20-84PP
	3/8"	8A TEF20-86N	8A TEF20-86PP
	1/2"	8A TEF20-88N	8A TEF20-88PP
	5/8"	8A TEF20-810N	8A TEF20-810PP
3/4"	3/4"	8A TEF20-812N	8A TEF20-812PP
	1/2"	8A TEF20-128N	8A TEF20-128PP
	5/8"	8A TEF20-1210N	8A TEF20-1210PP
	3/4"	8A TEF20-1212N	8A TEF20-1212PP



ELBOWS FPT X FPT

FPT	FPT	NYLON	POLYPROPYLENE
3/8"	3/8"	—	8A EL-66PP
1/2"	1/2"	8A EL-88N	8A EL-88PP
3/4"	3/4"	8A EL-1212N	8A EL-1212PP
1"	1"	8A EL-1616N	8A EL-1616PP
1-1/4"	1-1/4"	8A EL-2020N	8A EL-2020PP
1-1/2"	1-1/2"	8A EL-2424N	8A EL-2424PP
2"	2"	8A EL-3232N	8A EL-3232PP
3"	3"	—	8A EL-4848PP

Plastic Hose Barb & Pipe Fittings

PRICING CODE **8A**

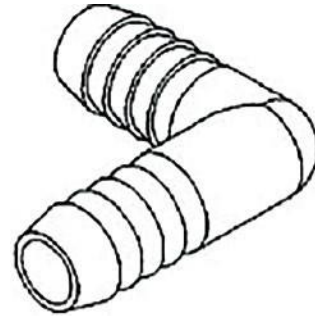

ELBOWS HB X HB

HB	HB	NYLON	POLYPROPYLENE
1/4"	1/4"	8A TEB20-44N	8A TEB20-44PP
3/8"	3/8"	8A TEB20-66N	8A TEB20-66PP
1/2"	1/2"	8A TEB20-88N	8A TEB20-88PP
5/8"	5/8"	8A TEB20-1010N	8A TEB20-1010PP
3/4"	3/4"	8A TEB20-1212N	8A TEB20-1212PP
1"	1"	8A TEB20-1616N	8A TEB20-1616PP
1-1/4"	1-1/4"	8A TEB20-2020N	8A TEB20-2020PP
1-1/2"	1-1/2"	8A TEB20-2424N	8A TEB20-2424PP
2"	2"	8A TEB20-3232N	8A TEB20-3232PP
3/8"	1/4"	—	8A TEB20-64PP
1/2"	1/4"	—	8A TEB20-84PP
	3/8"	—	8A TEB20-86PP
3/4"	5/8"	—	8A TEB20-1210PP

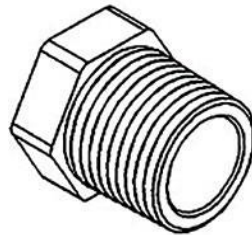

HEX HEAD PLUGS MPT

MPT	NYLON	POLYPROPYLENE	POLYETHYLENE
1/8"	8A TP40-02N	8A TP40-02PP	8A TP40-02P
1/4"	8A TP40-04N	8A TP40-04PP	8A TP40-04P
3/8"	8A TP40-06N	8A TP40-06PP	8A TP40-06P
1/2"	8A TP40-08N	8A TP40-08PP	8A TP40-08P
3/4"	8A TP40-12N	8A TP40-12PP	8A TP40-12P
1"	8A TP40-16N	8A TP40-16PP	—
1-1/4"	8A TP40-20N	8A TP40-20PP	—
1-1/2"	8A TP40-24N	8A TP40-24PP	—
2"	8A TP40-32N	8A TP40-32PP	—
3"	—	8A TP40-48PP	—
3/4 SQ	8A STP-12N	8A STP-12PP	—

Plastic Hose Barb & Pipe Fittings

PRICING CODE **8A**

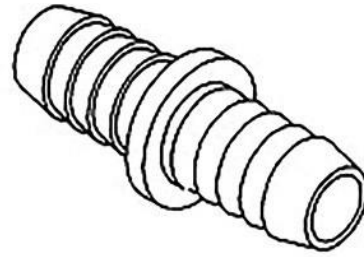

MENDERS HB X HB

HB	HB	NYLON	POLYPROPYLENE	POLYETHYLENE
1/8"	1/8"	8A TC70-22N	—	8A TC70-22P
1/5"	1/5"	8A TC70-33N	—	8A TC70-33P
1/4"	1/4"	8A TC70-44N	8A TC70-44PP	8A TC70-44P
1/3"	1/3"	8A TC70-55N	8A TC70-55PP	8A TC70-55P
3/8"	3/8"	8A TC70-66N	8A TC70-66PP	8A TC70-66P
1/2"	1/2"	8A TC70-88N	8A TC70-88PP	8A TC70-88P
5/8"	5/8"	8A TC7-1010N	8A TC7-010PP	8A TC7-1010P
3/4"	3/4"	8A TC7-1212N	8A TC7-212PP	—
1"	1"	8A TC7-1616N	8A TC7-1616PP	—
1-1/4"	1-1/4"	8A TC7-2020N	8A TC7-2020PP	—
1-1/2"	1-1/2"	8A TC7-2424N	8A TC7-2424PP	—
2"	2"	8A TC7-3232N	8A TC7-3232PP	—
3"	3"	—	8A TC7-4848PP	—
1/4"	1/8"	8A TRC80-42N	—	8A TRC80-42P
	1/5"	8A TRC80-43N	—	8A TRC80-43P
3/8"	1/4"	8A TRC80-64N	8A TRC80-64PP	8A TRC80-64P
	1/3"	8A TRC80-65N	—	—
1/2"	1/4"	8A TRC80-84N	8A TRC80-84PP	8A TRC80-84P
	3/8"	8A TRC80-86N	8A TRC80-86PP	8A TRC80-86P
5/8"	3/8"	8A TRC80-106N	8A TRC80-106PP	8A TRC80-106P
	1/2"	8A TRC80-108N	8A TRC80-108PP	8A TRC80-108P
3/4"	1/2"	8A TRC80-128N	—	8A TRC80-128P
3/8"	1/4PL	—	—	8A TRC80-64PPL

Plastic Hose Barb & Pipe Fittings

PRICING CODE **8A**

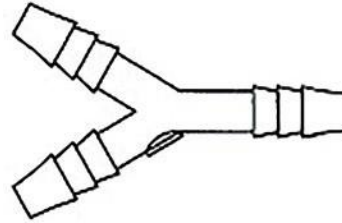

“Y” HB

HB	NYLON	POLYPROPYLENE
1/8"	—	8A TYY-222PP
1/5"	—	8A TYY-333PP
1/4"	8A TYY-444N	8A TYY-444PP
1/3"	8A TYY-555N	8A TYY-555PP
3/8"	—	8A TYY-666PP
1/2"	8A TYY-888N	8A TYY-888PP



NIPPLES MPT X MPT

MPT	MPT	NYLON	POLYPROPYLENE	POLYETHYLENE
1/8"	1/8"	8A TN50-22N	8A TN50-22PP	8A TN50-22P
1/4"	1/4"	8A TN50-44N	8A TN50-44PP	8A TN50-44P
3/8"	3/8"	8A TN50-66N	8A TN50-66PP	8A TN50-66P
1/2"	1/2"	8A TN50-88N	8A TN50-88PP	8A TN50-88P
3/4"	3/4"	8A TN5-1212N	8A TN5-1212PP	—
1"	1"	8A TN5-1616N	8A TN5-1616PP	—
1-1/4"	1-1/4"	8A TN5-2020N	8A TN5-2020PP	—
1-1/2"	1-1/2"	8A TN5-2424N	8A TN5-2424PP	—
2"	2"	8A TN5-3232N	8A TN5-3232PP	—

Continued on next page...

Plastic Hose Barb & Pipe Fittings

PRICING CODE **8A**



NIPPLES MPT X MPT *continued*

MPT	MPT	NYLON	POLYPROPYLENE	POLYETHYLENE
3"	3"	—	—	—
4"	4"	—	—	—
1/4"	1/8"	8A TRN60-42N	8A TRN60-42PP	8A TRN60-42P
3/8"	1/8"	8A TRN60-62N	8A TRN60-62PP	8A TRN60-62P
	1/4"	8A TRN60-64N	8A TRN60-64PP	8A TRN60-64P
1/2"	1/8"	8A TRN60-82N	—	8A TRN60-82P
	1/4"	8A TRN60-84N	8A TRN60-84PP	8A TRN60-84P
	3/8"	8A TRN60-86N	8A TRN60-86PP	8A TRN60-86P
3/4"	3/8"	8A TRN60-126N	8A TRN60-126PP	8A TRN60-126P
	1/2"	8A TRN60-128N	8A TRN60-128PP	—
1"	1/2"	—	8A TRN60-168PP	—
	3/4"	—	8A TRN60-1612PP	—
1-1/4"	3/4"	—	8A TRN60-2012PP	—
	1"	8A TRN60-2016N	8A TRN60-2016PP	—
1-1/2"	1"	—	8A TRN60-2416PP	—
	1-1/4"	—	8A TRN60-2420PP	—
2"	1-1/4"	—	8A TRN60-3220PP	—
	1-1/2"	—	8A TRN60-3224PP	—
3"	2"	—	8A TRN60-4832PP	—

Plastic Hose Barb & Pipe Fittings

PRICING CODE **8A**

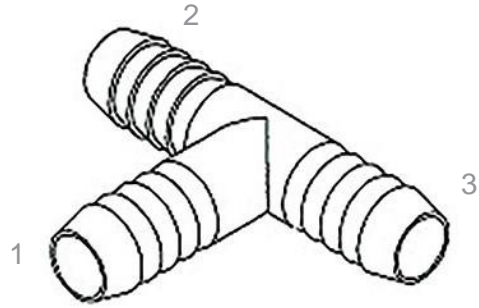

TEE HB X HB X HB

HB1	HB2	HB3	NYLON	POLYPROPYLENE	POLYETHYLENE
1/8"	1/8"	1/8	8A TT9-222N	—	8A TT9-222P
3/16"	3/16"	1/5	8A TT9-333N	—	8A TT9-333P
1/4"	1/4"	1/4	8A TT9-444N	8A TT9-444PP	8A TT9-444P
5/16"	5/16"	1/3	8A TT9-555N	8A TT9-555PP	8A TT9-555P
3/8"	3/8"	3/8	8A TT9-666N	8A TT9-666PP	8A TT9-666P
1/2"	1/2"	1/2	8A TT9-888N	8A TT9-888PP	8A TT9-888P
5/8"	5/8"	5/8	8A TT9-101010N	8A TT9-101010PP	8A TT9-101010P
3/4"	3/4"	3/4	8A TT9-121212N	8A TT9-121212PP	8A TT9-121212P
1"	1"	1	8A TT9-161616N	8A TT9-161616PP	8A TT9-161616P
1-1/4"	1-1/4"	1-1/4"	8A TT9-202020N	8A TT9-202020PP	—
1-1/2"	1-1/2"	1-1/2"	8A TT9-242424N	8A TT9-242424PP	—
2"	2"	2	8A TT9-323232N	8A TT9-323232PP	—
3"	3"	3	—	8A TT9-484848PP	—
1/4"	3/8"	3/8	8A TT9-466N	8A TT9-466PP	8A TT9-466P
	1/2"	1/2	8A TT9-488N	—	8A TT9-488P
	5/8"	5/8	8A TT9-41010N	—	8A TT9-41010P
3/8"	1/4"	1/4	8A TT9-644N	—	8A TT9-644P
	1/2"	1/2	8A TT9-688N	8A TT9-688PP	8A TT9-688P
	5/8"	5/8	8A TT9-61010N	8A TT9-61010PP	8A TT9-61010P
	3/4"	3/4	8A TT9-61212N	8A TT9-61212PP	—
1/2"	3/8"	3/8	8A TT9-866N	8A TT9-866PP	8A TT9-866P
	5/8"	5/8	8A TT9-81010N	—	8A TT9-81010P
	3/4"	3/4	8A TT9-81212N	—	8A TT9-81212P
3/4"	1/2"	1/2	8A TT9-1288N	8A TT9-1288PP	—

Plastic Hose Barb & Pipe Fittings

PRICING CODE **8A**

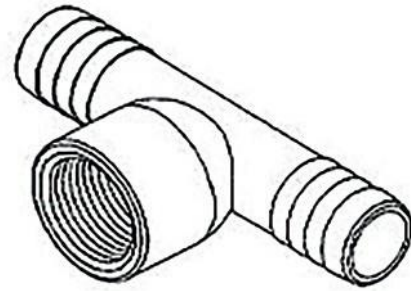

TEE FPT X HB

FPT	HB	HB	NYLON	POLYPROPYLENE
3/4"	3/4"	3/4	8A TTF-121212N	8A TTF-121212PP
	1-1/4"	1-1/4"	8A TTF-122020N	8A TTF-122020PP

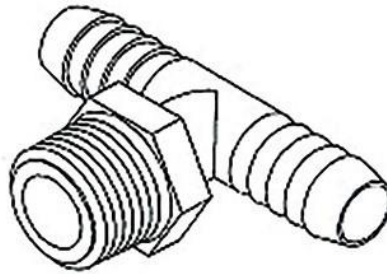

TEE MPT X HB X HB

MPT	HB	HB	NYLON	POLYPROPYLENE	POLYETHYLENE
1/4"	1/4"	1/4	8A TT3-444N	8A TT3-444PP	8A TT3-444P
3/8"	3/8"	3/8	8A TT3-666N	8A TT3-666PP	8A TT3-666P
1/2"	1/2"	1/2	8A TT3-888N	8A TT3-888PP	8A TT3-888P
3/4"	3/4"	3/4	8A TT3-121212N	8A TT3-121212PP	8A TT3-121212P
1"	1"	1	8A TT3-161616N	8A TT3-161616PP	—
1/8"	1/4"	1/4	8A TT3-244N	8A TT3-244PP	8A TT3-244P
1/4"	3/8"	3/8	8A TT3-466N	8A TT3-466PP	8A TT3-466P
	1/2"	1/2	8A TT3-488N	8A TT3-488PP	8A TT3-488P
3/8"	1/4"	1/4	8A TT3-644N	—	8A TT3-644P
	1/2"	1/2	8A TT3-688N	8A TT3-688PP	8A TT3-688P
1/2"	3/8"	3/8	8A TT3-866N	8A TT3-866PP	8A TT3-866P
	3/4"	3/4	8A TT3-81212N	8A TT3-81212PP	—
	1"	1	8A TT3-81616N	8A TT3-81616PP	—
3/4"	1/2"	1/2	8A TT3-1288N	8A TT3-1288PP	—
	5/8"	5/8	8A TT3-121010N	8A TT3-121010PP	—
	1"	1	8A TT3-121616N	8A TT3-121616PP	—

Plastic Hose Barb & Pipe Fittings

PRICING CODE **8A**

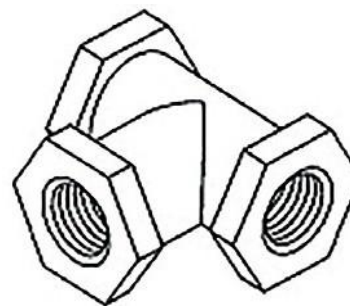

TEE FPT

FPT	NYLON	POLYPROPYLENE
1/4"	8A TT-4N	8A TT-4PP
3/8"	—	8A TT-6PP
1/2"	8A TT-8N	8A TT-8PP
3/4"	8A TT-12N	8A TT-12PP
1"	8A TT-16N	8A TT-16PP
1-1/4"	8A TT-20N	8A TT-20PP
1-1/2"	8A TT-24N	8A TT-24PP
2"	8A TT-32N	8A TT-32PP
3"	—	8A TT-48PP

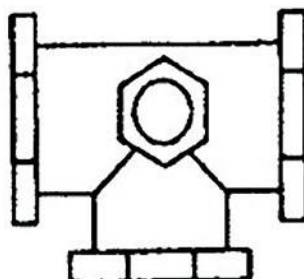

GAUGE TEE

FPT	PORT	NYLON	POLYPROPYLENE
1/2"	1/4"	8A TT-8-4N	8A TT-8-4PP
3/4"	1/8"	8A TT-12-2N	8A TT-12-2PP
	1/4"	8A TT-12-4N	8A TT-12-4PP
1"	1/4"	8A TT-16-4N	8A TT-16-4PP
1-1/4"	1/4"	8A TT-20-4N	8A TT-20-4PP
1-1/2"	1/4"	8A TT-24-4N	8A TT-24-4PP
2"	1/4"	8A TT-32-4N	8A TT-32-4PP

Plastic Hose Barb & Pipe Fittings

PRICING CODE **8A**

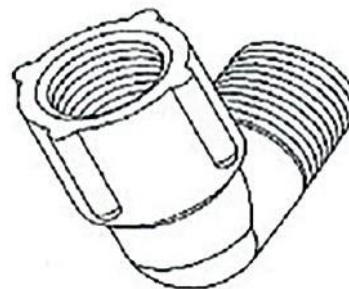

90° STREET ELBOW (SE)

MPT	FPT	NYLON	POLYPROPYLENE
1/8"	1/8"	8A SE-22N	8A SE-22PP
1/4"	1/4"	8A SE-44N	8A SE-44PP
3/8"	3/8"	8A SE-66N	8A SE-66PP
1/2"	1/2"	8A SE-88N	8A SE-88PP
3/4"	3/4"	8A SE-1212N	8A SE-1212PP
1"	1"	8A SE-1616N	8A SE-1616PP
1-1/4"	1-1/4"	8A SE-2020N	8A SE-2020PP
1-1/2"	1-1/2"	8A SE-2424N 8A SE-3232N	8A SE-2424PP 8A SE-3232PP
2"	2"		8A SE-4848PP
3"	3"	—	

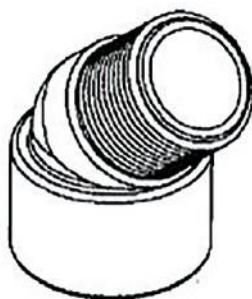

45° STREET ELBOW (SEQ)

MPT	FPT	NYLON	POLYPROPYLENE
1/4"	1/4"	8A SEQ-44N	8A SEQ-44PP
3/4"	3/4"	8A SEQ-1212N	8A SEQ-1212PP
1"	1"	—	8A SEQ-1616PP
1-1/4"	1-1/4"	—	8A SEQ-2020PP
1-1/2"	1-1/2"	—	8A SEQ-2424PP
2"	2"	—	8A SEQ-3232PP
3"	3"	—	8A SEQ-4848PP

Plastic Hose Barb & Pipe Fittings

PRICING CODE **8A**

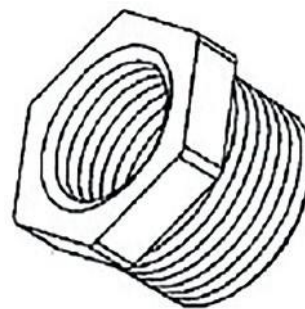

REDUCER BUSHINGS MPT X FPT

MPT	FPT	NYLON	POLYPROPYLENE
1/4"	1/8"	8A RB-42N	8A RB-42PP
3/8"	1/8"	8A RB-62N	8A RB-62PP
	1/4"	8A RB-64N	8A RB-64PP
1/2"	1/8"	8A RB-82N	8A RB-82PP
	1/4"	8A RB-84N	8A RB-84PP
	3/8"	8A RB-86N	8A RB-86PP
3/4"	1/8"	8A RB-122N	8A RB-122PP
	1/4"	8A RB-124N	8A RB-124PP
	3/8"	8A RB-126N	8A RB-126PP
	1/2"	8A RB-128N	8A RB-128PP
1"	3/8"	8A RB-166N	8A RB-166PP
	1/2"	8A RB-168N	8A RB-168PP
	3/4"	8A RB-1612N	8A RB-1612PP
1-1/4"	1/2"	8A RB-208N	8A RB-208PP
	3/4"	8A RB-2012N	8A RB-2012PP
	1"	8A RB-2016N	8A RB-2016PP
1-1/2"	1/2"	8A RB-248N	8A RB-248PP
	3/4"	8A RB-2412N	8A RB-2412PP
	1"	8A RB-2416N	8A RB-2416PP
	1-1/4"	8A RB-2420N	8A RB-2420PP
2"	1/2"	8A RB-328N	8A RB-328PP
	3/4"	8A RB-3212N	8A RB-3212PP
	1"	8A RB-3216N	8A RB-3216PP
	1-1/4"	8A RB-3220N	8A RB-3220PP
	1-1/2"	8A RB-3224N	8A RB-3224PP
3"	1-1/2"	—	8A RB-4824PP
	2"	8A RB-4832N	8A RB-4832PP

Plastic Hose Barb & Pipe Fittings

PRICING CODE **8A**



CROSS FPT

FPT	POLYPROPYLENE
1/4"	8A CR-4PP
3/8"	8A CR-6PP
1/2"	8A CR-8PP
3/4"	8A CR-12PP
1"	8A CR-16PP
1-1/4"	8A CR-20PP
1-1/2"	8A CR-24PP
2"	8A CR-32PP

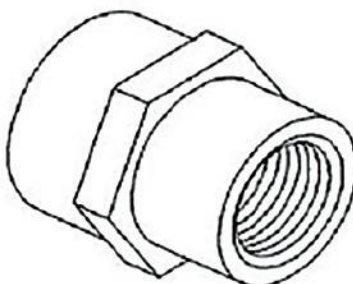

COUPLING FPT

FPT	FPT	NYLON	POLYPROPYLENE
1/8"	1/8"	8A CC-22N	8A CC-22PP
1/4"	1/4"	8A CC-44N	8A CC-44PP
	1/4"	8A CC-44N-S	8A CC-44PP-S
3/8"	3/8"	8A CC-66N	8A CC-66PP
1/2"	1/2"	8A CC-88N	8A CC-88PP
3/4"	3/4"	8A CC-1212N	8A CC-1212PP
1"	1"	8A CC-1616N	8A CC-1616PP
1-1/4"	1-1/4"	8A CC-2020N	8A CC-2020PP
1-1/2"	1-1/2"	8A CC-2424N	8A CC-2424PP
2"	2"	8A CC-3232N	8A CC-3232PP
3"	3"	—	8A CC-4848PP

Continued on next page...

Plastic Hose Barb & Pipe Fittings

PRICING CODE **8A**

COUPLING FPT *continued*

FPT	FPT	NYLON	POLYPROPYLENE
1/4"	1/8"	8A RC-42N	8A RC-42PP
	1/8"	8A RC-42N-S	—
3/8"	1/4"	8A RC-64N	8A RC-64PP
1/2"	3/8"	8A RC-86N	8A RC-86PP
3/4"	3/8"	8A RC-126N	8A RC-126PP
	1/2"	8A RC-128N	8A RC-128PP
1"	3/4"	—	8A RC-1612PP
1-1/2"	1"	—	8A RC-2416PP
	1-1/4"	—	8A RC-2420PP
2"	1"	—	8A RC-3216PP
	1-1/4"	—	8A RC-3220PP
	1-1/2"	—	8A RC-3224PP
3"	2"	—	8A RC-4832PP

CAP FPT (HC)

FPT	NYLON	POLYPROPYLENE
1/4"	8A HC-44N-S	8A HC-44PP-S
3/8"	8A HC-66N	8A HC-66PP
1/2"	8A HC-88N	8A HC-88PP
3/4"	8A HC-1212N	8A HC-1212PP

SWIVEL NUT (SN) INSERT (SNA)

FPT	HB	NYLON	POLYPROPYLENE
1/4"	—	8A SN-4N	8A SN-4PP
—	1/4"	8A SNA-4N	8A SNA-4PP
3/8"	—	8A SN-6N	8A SN-6PP
—	3/8"	8A SNA-6N	8A SNA-6PP
1/2"	—	8A SN-8N	8A SN-8PP
—	1/4"	8A SNA-84N	8A SNA-84PP
—	1/2"	8A SNA-8N	8A SNA-8PP

Plastic Hose Barb & Pipe Fittings

PRICING CODE **8A**

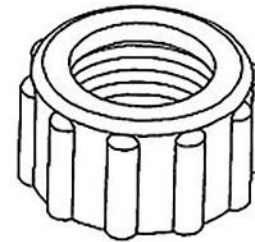

SWIVEL NUTS

SW NUT	NYLON	POLYPROPYLENE
FGHT	8A GHN-12N	8A GHN-12PP
3/4 FPS	8A HN-12N	8A HN-12PP



SW NUT HB INSERTS

HB INSERT	NYLON	POLYPROPYLENE
1/4"	8A GHA-4N	8A GHA-4PP
3/8"	8A GHA-6N	8A GHA-6PP
1/2"	8A GHA-8N	8A GHA-8PP
5/8"	8A GHA-10N	8A GHA-10PP
3/4"	8A GHA-12N	8A GHA-12PP
1/2 MPT	8A GHA8-NMPT	8A GHA8PP-MPT

WASHERS

WASHER	NYLON
Flat Washer	8A GHW
Filter Washer	8A FWG-3030
Filter Washer	8A FWG-6050

Plastic Hose Barb & Pipe Fittings

PRICING CODE **8A**

GHT CAP

FGHT	NYLON	POLYPROPYLENE
3/4"	8A GHC-12N	8A GHC-12PP

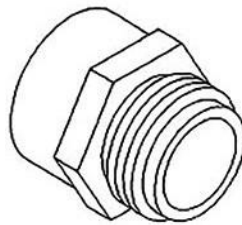

MGHT X FPT

MGHT	FPT	NYLON	POLYPROPYLENE
3/4"	1/4"	8A GFA-124N	8A GFA-124PP
	1/2"	8A GFA-128N	8A GFA-128PP
	3/4"	8A GFA-1212N	8A GF-A1212PP

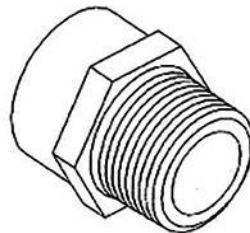

FGHT X MPT

FGHT	MPT	NYLON	POLYPROPYLENE
3/4"	3/4"	8A GMA-1212N	8A GMA-1212PP
	3/4 Mght	8A FGP-12N	8A FGP-12PP

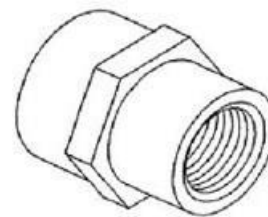

FGHT X FPT

FGHT	FPT	NYLON	POLYPROPYLENE
3/4"	1/2"	8A GHF-128N	8A GHF-128PP
	3/4"	8A GHF-1212N	8A GHF-1212PP

Plastic Hose Barb & Pipe Fittings

PRICING CODE **8A**

FGHT X FGHT

FGHT	FGHT	NYLON	POLYPROPYLENE
3/4"	3/4"	8A FGHT-1212N	8A FGHT-1212PP



MGHT X MPT

MGHT	MPT	NYLON	POLYPROPYLENE
3/4"	3/8"	8A GPN-6N	8A GPN-6PP
	1/2"	8A GPN-8N	8A GPN-8PP
	3/4"	8A GPN-12N	8A GPN-12PP
	1"	8A GPN-16N	8A GPN-16PP

MGHT X MGHT

MGHT	MGHT	NYLON	POLYPROPYLENE
3/4"	3/4"	8A GN-12N	8A GN-12PP

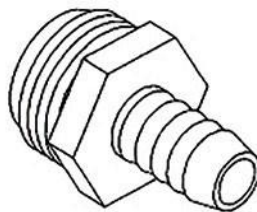

STR. MGHT X HB

HB	NYLON	POLYPROPYLENE
1/4"	8A GA10-4N	8A GA10-4PP
3/8"	8A GA10-6N	8A GA10-6PP
1/2"	8A GA10-8N	8A GA10-8PP
5/8"	8A GA10-10N	8A GA10-10PP
3/4"	8A GA10-12N	8A GA10-12PP

Plastic Hose Barb & Pipe Fittings

PRICING CODE

8A

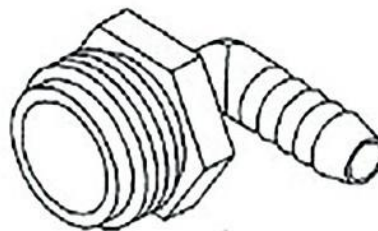

ELBOW MGHT X HB

HB	NYLON	POLYPROPYLENE
1/4"	8A GE20-4N	8A GE20-4PP
3/8"	8A GE20-6N	8A GE20-6PP
1/2"	8A GE20-8N	8A GE20-8PP
5/8"	8A GE20-10N	8A GE20-10PP
3/4"	8A GE20-12N	8A GE20-12PP

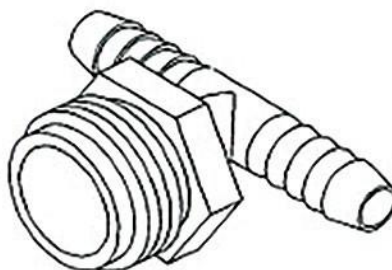

TEE MGHT X HB

HB	NYLON	POLYPROPYLENE
3/8"	8A GT12-6N	8A GT12-6PP
1/2"	8A GT12-8N	8A GT12-8PP
5/8"	8A GT12-10N	8A GT12-10PP
3/4"	8A GT12-12N	8A GT12-12PP

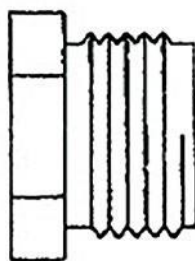

GARDEN HOSE PLUG

MGHT	NYLON	POLYPROPYLENE
3/4"	8A GHP-12N	8A GHP-12PP

**THIS PAGE IS
INTENTIONALLY
LEFT BLANK**

Brass Fittings

PRICING CODE

7A

201A - HOSE BARBS TO MPT



PART #	SIZE BARB X MPT
7A 201A-2A	1/8" X 1/8"
7A 201A-3A	3/16" X 1/8"
7A 201A-3B	3/16" X 1/4"
7A 201A-4A	1/4" X 1/8"
7A 201A-4B	1/4" X 1/4"
7A 201A-4C	1/4" X 3/8"
7A 201A-4D	1/4" X 1/2"
7A 201A-5A	5/16" X 1/8"
7A 201A-5B	5/16" X 1/4"
7A 201A-5C	5/16" X 3/8"
7A 201A-6A	3/8" X 1/8"
7A 201A-6B	3/8" X 1/4"
7A 201A-6C	3/8" X 3/8"
7A 201A-6D	3/8" X 1/2"
7A 201A-6E	3/8" X 3/4"
7A 201A-8B	1/2" X 1/4"
7A 201A-8C	1/2" X 3/8"
7A 201A-8D	1/2" X 1/2"
7A 201A-8E	1/2" X 3/4"
7A 201A-8F	1/2" X 1"
7A 201A-10C	5/8" X 3/8"
7A 201A-10D	5/8" X 1/2"
7A 201A-10E	5/8" X 3/4"
7A 201A-10F	5/8" X 1"
7A 201A-12C	3/4" X 3/8"
7A 201A-12D	3/4" X 1/2"
7A 201A-12E	3/4" X 3/4"
7A 201A-12F	3/4" X 1"
7A 201A-16E	1" X 3/4"
7A 201A-16F	1" X 1"
7A 201A-20F	1-1/4" X 1"

Brass Fittings

PRICING CODE

7A

HM - HOSE MENDER



PART #	SIZE I.D. TUBE
7A HM-3	3/16"
7A HM-4	1/4"
7A HM-5	5/16"
7A HM-6	3/8"
7A HM-8	1/2"
7A HM-10	5/8"
7A HM-12	3/4"
7A HM-16	1"

HE1 - HOSE BARB ELBOW TO MPT



PART #	SIZE BARB X MPT
7A HE1-4A	1/4" X 1/8"
7A HE1-4B	1/4" X 1/4"
7A HE1-4C	1/4" X 3/8"
7A HE1-5A	5/16" X 1/8"
7A HE1-5B	5/16" X 1/4"
7A HE1-5C	5/16" X 3/8"
7A HE1-6A	3/8" X 1/8"
7A HE1-6B	3/8" X 1/4"
7A HE1-6C	3/8" X 3/8"
7A HE1-6D	3/8" X 1/2"
7A HE1-8B	1/2" X 1/4"
7A HE1-8C	1/2" X 3/8"
7A HE1-8D	1/2" X 1/2"
7A HE1-10C	5/8" X 3/8"
7A HE1-10D	5/8" X 1/2"
7A HE1-12D	3/4" X 1/2"
7A HE1-12E	3/4" X 3/4"

Brass Fittings

PRICING CODE

7A

HE145 - 45° HOSE BARB ELBOW TO MPT



PART #	SIZE BARB X MPT
7A HE145-4A	1/4" X 1/8"
7A HE145-4B	1/4" X 1/4"
7A HE145-5B	5/16" X 1/4"
7A HE145-6A	3/8" X 1/8"
7A HE145-6B	3/8" X 1/4"
7A HE145-6C	3/8" X 3/8"
7A HE145-8B	1/2" X 1/4"
7A HE145-8C	1/2" X 3/8"
7A HE145-10C	5/8" X 3/8"

209A - HOSE BARB TO FPT

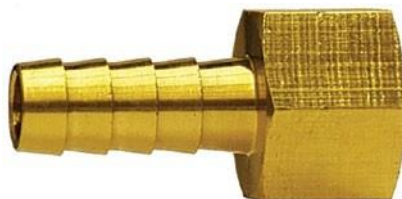

PART #	SIZE BARB X FPT
7A 209A-3A	3/16" X 1/8"
7A 209A-3B	3/16" X 1/4"
7A 209A-4A	1/4" X 1/8"
7A 209A-4B	1/4" X 1/4"
7A 209A-4C	1/4" X 3/8"
7A 209A-5A	5/16" X 1/8"
7A 209A-5B	5/16" X 1/4"
7A 209A-5C	5/16" X 3/8"
7A 209A-6A	3/8" X 1/8"
7A 209A-6B	3/8" X 1/4"
7A 209A-6C	3/8" X 3/8"
7A 209A-6D	3/8" X 1/2"
7A 209A-8B	1/2" X 1/4"
7A 209A-8C	1/2" X 3/8"
7A 209A-8D	1/2" X 1/2"
7A 209A-8E	1/2" X 3/4"
7A 209A-12E	3/4" X 3/4"

Brass Fittings

PRICING CODE 7A

209AS - HOSE BARB TO SWIVEL BALL SEAT



PART #	SIZE BARB X FPT
7A 209AS-2A	1/8" X 1/8"
7A 209AS-3A	3/16" X 1/8"
7A 209AS-3B	3/16" X 1/4"
7A 209AS-4B	1/4" X 1/4"
7A 209AS-5B	5/16" X 1/4"
7A 209AS-6B	3/8" X 1/4"
7A 209AS-6C	3/8" X 3/8"
7A 209AS-8C	1/2" X 3/8"
7A 209AS-8D	1/2" X 1/2"
7A 209AS-12E	3/4" X 3/4"

209ASF - HOSE BARB TO FEMALE FLARE, SWIVEL



PART #	SIZE BARB X FEMALE FLARE
7A 209ASF-44	1/4" X 1/4"
7A 209ASF-46	1/4" X 3/8"
7A 209ASF-55	5/16" X 5/16"
7A 209ASF-66	3/8" X 3/8"
7A 209ASF-68	3/8" X 1/2"
7A 209ASF-88	1/2" X 1/2"

FJS - HOSE BARB TO FEMALE SWIVEL J.I.C. — 37°



PART #	SIZE BARB X FPT	BARB LENGTH	HEX SIZE
7A FJS-05-06	5/16" X 9/16-1"	0.97"	11/16"
7A FJS-06-06	3/8" X 9/16-18"	0.97"	11/16"

Brass Fittings

PRICING CODE 7A

FSS - HOSE BARB TO FEMALE SWIVEL S.A.E. — 45°



PART #	SIZE BARB X FPT	BARB LENGTH	HEX SIZE
7A FSS-04-06	1/4" X 5/8-18"	0.97"	3/4"
7A FSS-05-06	5/16" X 5/8-18"	0.97"	3/4"
7A FSS-06-06	3/8" X 5/8-18"	0.97"	3/4"

FDS - HOSE BARB TO FEMALE SWIVEL DUAL SEAT



PART #	SIZE BARB X FPT	BARB LENGTH	HEX SIZE
7A FDS-04-04	1/4" X 7/16-20"	0.97"	9/16"
7A FDS-04-05	1/4" X 1/2-20"	0.97"	5/8"
7A FDS-05-05	5/16" X 1/2-20"	0.97"	5/8"
7A FDS-06-08	3/8" X 3/4-16"	0.97"	7/8"
7A FDS-08-08	1/2" X 3/4-16"	0.97"	7/8"
7A FDS-08-10	1/2" X 7/8-14"	0.97"	1"

SMS - HOSE BARB TO MALE PIPE SWIVEL



PART #	SIZE BARB X MPT	BARB LENGTH	HEX SIZE
7A SMS-04-04	1/4" X 1/4-18"	0.97"	9/16"
7A SMS-06-04	3/8" X 1/4-18"	0.97"	9/16"
7A SMS-06-06	3/8" X 3/8-18"	0.97"	11/16"
7A SMS-08-06	1/2" X 3/8-18"	0.97"	11/16"
7A SMS-08-08	1/2" X 1/2-14"	0.97"	7/8"
7A SMS-12-12	3/4" X 3/4-14"	0.97"	1-1/16"

Brass Fittings

PRICING CODE

7A

NPF - HOSE BARB TO FEMALE SWIVEL



PART #	SIZE BARB X FPT	BARB LENGTH	HEX SIZE
7A NPF-10	5/8" X 3/4-14"	1.19"	1-3/16"
7A NPF-12	3/4" X 3/4-14"	1.19"	1-3/16"

HLM - "PUSH-ON" HOSE BARB TO MALE PIPE



PART #	SIZE BARB X MPT	BARB LENGTH	HEX SIZE
7A HLM-04-02	1/4" X 1/8-27"	0.87"	1/2"
7A HLM-04-04	1/4" X 1/4-18"	0.87"	9/16"
7A HLM-04-06	1/4" X 3/8-18"	0.87"	11/16"
7A HLM-05-04	5/16" X 1/4-1"	0.87"	9/16"
7A HLM-06-02	3/8" X 1/8-27"	0.97"	1/2"
7A HLM-06-04	3/8" X 1/4-18"	0.97"	9/16"
7A HLM-06-06	3/8" X 3/8-18"	0.97"	11/16"
7A HLM-06-08	3/8" X 1/2-14"	0.97"	7/8"
7A HLM-08-04	1/2" X 1/4-18"	0.97"	9/16"
7A HLM-08-06	1/2" X 3/8-18"	0.97"	11/16"
7A HLM-08-08	1/2" X 1/2-14"	0.97"	7/8"
7A HLM-08-12	1/2" X 3/4-14"	0.97"	1-1/16"
7A HLM-10-08	5/8" X 1/2-14"	1.45"	7/8"
7A HLM-10-12	5/8" X 3/4-14"	1.45"	1-1/16"
7A HLM-12-08	3/4" X 1/2-14"	1.45"	7/8"
7A HLM-12-12	3/4" X 3/4-14"	1.45"	1-1/16"
7A HLM-16-16	1" X 1-14"	1.45"	1-1/16"

Brass Fittings

PRICING CODE 7A

HLF - "PUSH-ON" HOSE BARB TO FEMALE PIPE SOLID



PART #	SIZE BARB X FPT	BARB LENGTH	HEX SIZE
7A HLF-04-02	1/4" X 1/8-27"	0.87"	1/2"
7A HLF-04-04	1/4" X 1/4-18"	0.87"	5/8"
7A HLF-05-04	5/16" X 1/4-18"	0.87"	5/8"
7A HLF-06-04	3/8" X 1/4-18"	0.97"	5/8"
7A HLF-06-06	3/8" X 3/8-18"	0.97"	3/4"
7A HLF-08-06	1/2" X 3/8-18"	0.97"	3/4"
7A HLF-08-08	1/2" X 1/2-14"	0.97"	15/16"

HJF - "PUSH-ON" HOSE BARB TO FEMALE SWIVEL J.I.C. — 37°



PART #	SIZE BARB X FPT	BARB LENGTH	HEX SIZE
7A HJF-04-04	1/4" X 7/16-20"	0.87"	9/16"
7A HJF-04-06	1/4" X 9/16-18"	0.87"	11/16"
7A HJF-06-06	3/8" X 9/16-18"	0.97"	11/16"
7A HJF-12-12	3/4" X 1-1/16-1"	1.45"	1-1/4"

HSF - "PUSH-ON" HOSE BARB TO FEMALE SWIVEL J.I.C. — 45°



PART #	SIZE BARB X FPT	BARB LENGTH	HEX SIZE
7A HSF-04-06	1/4" X 5/8-18"	0.87"	3/4"
7A HSF-05-06	5/16" X 5/8-18"	0.87"	3/4"
7A HSF-06-06	3/8" X 5/8-18"	0.97"	3/4"
7A HSF-12-12	3/4" X 1-1/16-1"	1.45"	1-1/4"

Nuts are notched to identify S.A.E. Thread

Brass Fittings

PRICING CODE

7A

HDF - "PUSH-ON" HOSE BARB TO FEMALE SWIVEL-DUAL ANGLE



PART #	SIZE BARB X FPT	BARB LENGTH	HEX SIZE
7A HDF-04-04	1/4" X 7/16-2"	0.87"	9/16"
7A HDF-04-05	1/4" X 1/2-20"	0.87"	5/8"
7A HDF-05-05	5/16" X 1/2-2"	0.87"	5/8"
7A HDF-06-08	3/8" X 3/4-16"	0.97"	7/8"
7A HDF-08-08	1/2" X 3/4-16"	0.97"	7/8"
7A HDF-08-10	1/2" X 7/8-14"	0.97"	1"
7A HDF-10-08	5/8" X 3/4-16"	1.45"	7/8"
7A HDF-10-10	5/8" X 7/8-14"	1.45"	1"

MHL - "PUSH-ON" HOSE BARB MENDER



PART #	SIZE I.D. TUBE	BARB LENGTH
7A MHL-04-04	1/4"	0.87"
7A MHL-05-05	5/16"	0.87"
7A MHL-06-06	3/8"	0.97"
7A MHL-08-08	1/2"	0.97"
7A MHL-10-10	5/8"	1.45"
7A MHL-12-12	3/4"	1.45"

HMS - "PUSH-ON" HOSE BARB TO MALE PIPE SWIVEL



PART #	SIZE BARB X MPT	BARB LENGTH	HEX SIZE
7A HMS-04-04	1/4" X 1/4-18"	0.87"	9/16"
7A HMS-06-04	3/8" X 1/4-18"	0.97"	9/16"
7A HMS-06-06	3/8" X 3/8-18"	0.97"	11/16"
7A HMS-08-06	1/2" X 3/8-18"	0.97"	11/16"
7A HMS-08-08	1/2" X 1/2-14"	0.97"	7/8"
7A HMS-12-12	3/4" X 3/4-14"	1.45"	1-1/16"

Brass Fittings

PRICING CODE 7A

100AF - ELBOW FPT TO FPT - FORGED



PART #	SIZE FPT
7A 100AF-A	1/8" X 1/8"
7A 100AF-B	1/4" X 1/4"
7A 100AF-C	3/8" X 3/8"
7A 100AF-D	1/2" X 1/2"

100A - ELBOW FPT TO FPT



PART #	SIZE FPT
7A 100A-A	1/8" X 1/8"
7A 100A-B	1/4" X 1/4"
7A 100A-BA	1/4" X 1/8"
7A 100A-C	3/8" X 3/8"
7A 100A-D	1/2" X 1/2"
7A 100A-DC	1/2" X 3/8"
7A 100AF-DC	1/2" X 3/8"
7A 100A-E	3/4" X 3/4"

100-45A 45° ELBOW FPT TO FPT



PART #	SIZE FPT
7A 100-45A-A	1/8"
7A 100-45A-B	1/4"
7A 100-45A-C	3/8"
7A 100-45A-D	1/2"

Brass Fittings

PRICING CODE

7A

101AF - TEE FPT ALL ENDS - FORGED



PART #	SIZE FPT
7A 101AF-A	1/8"
7A 101AF-B	1/4"
7A 101AF-C	3/8"
7A 101AF-D	1/2"

101A - TEE FPT ALL ENDS



PART #	SIZE FPT
7A 101A-A	1/8"
7A 101A-B	1/4"
7A 101A-BBA	1/4" X 1/4" X 1/8"
7A 101A-C	3/8"
7A 101A-CCB	3/8" X 3/8" X 1/4"
7A 101A-D	1/2"
7A 101A-DDC	1/2" X 1/2" X 3/8"
7A 101A-E	3/4"

102A - CROSS FPT ALL ENDS



PART #	SIZE FPT
7A 102A-A	1/8"
7A 102A-B	1/4"
7A 102A-C	3/8"
7A 102A-D	1/2"
7A 102A-E	3/4"

Brass Fittings

PRICING CODE 7A

103A - COUPLING FPT TO FPT

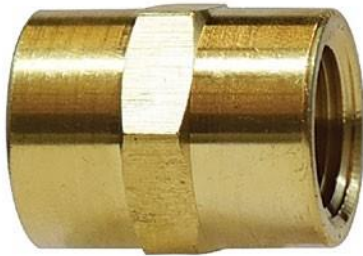

PART #	SIZE FPT
7A 103A-A	1/8"
7A 103A-B	1/4"
7A 103A-C	3/8"
7A 103A-D	1/2"
7A 103A-E	3/4"

104A - UNION FPT TO FPT



PART #	SIZE FPT
7A 104A-A	1/8"
7A 104A-B	1/4"
7A 104A-C	3/8"
7A 104A-D	1/2"
7A 104A-E	3/4"

108A - CAP FPT

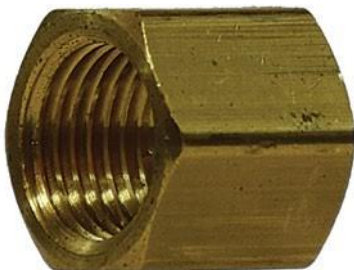

PART #	SIZE FPT
7A 108A-A	1/8"
7A 108A-B	1/4"
7A 108A-C	3/8"
7A 108A-D	1/2"
7A 108A-E	3/4"

Brass Fittings

PRICING CODE | 7A

110B - FACE BUSHING MPT TO FPT

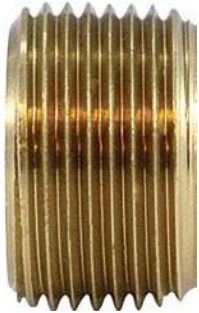

PART #	SIZE MPT X FPT
7A 110FB-DC	1/2" X 3/8"

109AS - SQUARE PLUG, MPT

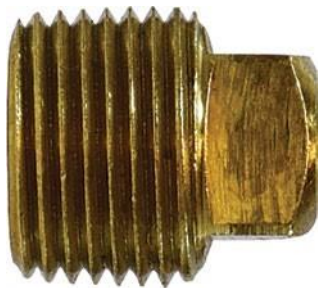

PART #	SIZE MPT
7A 109AS-A	1/8"
7A 109AS-B	1/4"
7A 109AS-C	3/8"
7A 109AS-D	1/2"
7A 109AS-E	3/4"
7A 109AS-F	1"

109CS - PLUG, COUNTER SUNK MPT



PART #	SIZE MPT
7A 109CS-A	1/8"
7A 109CS-B	1/4"
7A 109CS-C	3/8"
7A 109CS-D	1/2"
7A 109CS-E	3/4"

Brass Fittings

PRICING CODE | 7A

110A - BUSHING MPT TO FPT



PART #	SIZE MPT X FPT
7A 110A-BA	1/4" X 1/8"
7A 110A-CA	3/8" X 1/8"
7A 110A-CB	3/8" X 1/4"
7A 110A-DA	1/2" X 1/8"
7A 110A-DB	1/2" X 1/4"
7A 110A-DC	1/2" X 3/8"
7A 110A-EA	3/4" X 1/8"
7A 110A-EB	3/4" X 1/4"
7A 110A-EC	3/4" X 3/8"
7A 110A-ED	3/4" X 1/2"
7A 110A-FB	1" X 1/4"
7A 110A-FC	1" X 3/8"
7A 110A-FD	1" X 1/2"
7A 110A-FE	1" X 3/4"

111A - LOCK NUT



PART #	SIZE FPT
7A 111A-A	1/8"
7A 111A-B	1/4"
7A 111A-C	3/8"
7A 111A-D	1/2"
7A 111A-E	3/4"

Brass Fittings

PRICING CODE

7A

112A - CLOSE NIPPLE



PART #	SIZE MPT
7A 112A-A	1/8"
7A 112A-B	1/4"
7A 112A-C	3/8"
7A 112A-D	1/2"
7A 112A-E	3/4"
7A 112A-F	1"

113A - LONG NIPPLE



PART #	SIZE MPT
7A 113A-A15	1/8" X 1-1/2"
7A 113A-A2	1/8" X 2"
7A 113A-A3	1/8" X 3"
7A 113A-B15	1/4" X 1-1/2"
7A 113A-B2	1/4" X 2"
7A 113A-B2.5	1/4" X 2-1/2"
7A 113A-B3	1/4" X 3"
7A 113A-B3.5	1/4" X 3-1/2"
7A 113A-B4	1/4" X 4"
7A 113A-C15	3/8" X 1-1/2"
7A 113A-C2	3/8" X 2"
7A 113A-C2.5	3/8" X 2-1/2"
7A 113A-C3	3/8" X 3"
7A 113A-D15	1/2" X 1-1/2"
7A 113A-D2	1/2" X 2"
7A 113A-D3	1/2" X 3"
7A 113A-E15	3/4" X 1-1/2"
7A 113A-E2	3/4" X 2"

Brass Fittings

PRICING CODE | 7A

116AF - STREET ELBOW FPT TO MPT - FORGED



PART #	SIZE FPT X MPT
7A 116AF-A	1/8"
7A 116AF-B	1/4"
7A 116AF-C	3/8"
7A 116AF-D	1/2"
7A 116AF-E	3/4"

116A - STREET ELBOW FPT TO MPT



PART #	SIZE FPT X MPT
7A 116A-A	1/8"
7A 116A-B	1/4"
7A 116A-C	3/8"
7A 116A-D	1/2"
7A 116A-E	3/4"

116AM - MALE ELBOW MPT TO MPT



PART #	SIZE MPT
7A 116AM-A	1/8"
7A 116AM-B	1/4"
7A 116AM-BA	1/4" X 1/8"
7A 116AM-C	3/8"
7A 116AM-CB	3/8" X 1/4"
7A 116AM-D	1/2"
7A 116AM-DC	1/2" X 3/8"

117A - PLUG, SLOTTED MPT



PART #	SIZE MPT
7A 117A-A	1/8"
7A 117A-B	1/4"
7A 117A-C	3/8"

Brass Fittings

PRICING CODE | 7A

119A - REDUCER FPT TO FPT



PART #	SIZE FPT
7A 119A-BA	1/4" X 1/8"
7A 119A-CA	3/8" X 1/8"
7A 119A-CB	3/8" X 1/4"
7A 119A-DA	1/2" X 1/8"
7A 119A-DB	1/2" X 1/4"
7A 119A-DC	1/2" X 3/8"
7A 119A-ED	3/4" X 1/2"

120A - ADAPTER FPT TO MPT



PART #	SIZE FPT X MPT
7A 120A-AA	1/8" X 1/8"
7A 120A-BA	1/4" X 1/8"
7A 120A-BB	1/4" X 1/4"
7A 120A-CA	3/8" X 1/8"
7A 120A-CB	3/8" X 1/4"
7A 120A-CC	3/8" X 3/8"
7A 120A-DB	1/2" X 1/4"
7A 120A-DC	1/2" X 3/8"
7A 120A-DD	1/2" X 1/2"
7A 120A-ED	3/4" X 1/2"

121A - PLUG, CORED HEX HEAD MPT



PART #	SIZE MPT
7A 121A-A	1/8"
7A 121A-B	1/4"
7A 121A-C	3/8"
7A 121A-D	1/2"
7A 121A-E	3/4"
7A 121A-F	1"

Brass Fittings

PRICING CODE | 7A

121AS - MPT SOLID HEX HEAD PLUG

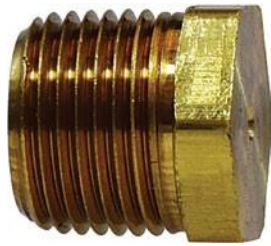

PART #	SIZE MPT
7A 121AS-A	1/8"
7A 121AS-B	1/4"
7A 121AS-C	3/8"
7A 121AS-D	1/2"
7A 121AS-E	3/4"
7A 121AS-F	1"

122A - HEX MPT TO MPT



PART #	SIZE MPT
7A 122A-A	1/8"
7A 122A-B	1/4"
7A 122A-C	3/8"
7A 122A-D	1/2"
7A 122A-E	3/4"
7A 122A-F	1"

123A - REDUCING NIPPLE MPT TO MPT



PART #	SIZE MPT
7A 123A-BA	1/4" X 1/8"
7A 123A-CA	3/8" X 1/8"
7A 123A-CB	3/8" X 1/4"
7A 123A-DB	1/2" X 1/4"
7A 123A-DC	1/2" X 3/8"
7A 123A-ED	3/4" X 1/2"

Brass Fittings

PRICING CODE

7A

124A - 45° STREET ELBOW FPT TO MPT



PART #	SIZE FPT X MPT
7A 124A-A	1/8"
7A 124A-B	1/4"
7A 124A-C	3/8"
7A 124A-D	1/2"
7A 124A-E	3/4"

127AF - STREET TEE FPT TO MPT TO FPT - FORGED

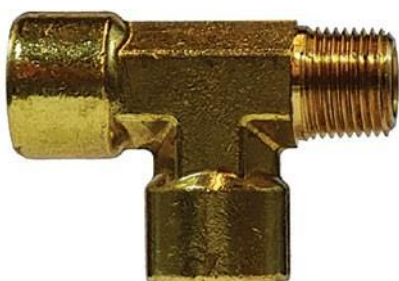

PART #	SIZE MPT X FPT X FPT
7A 127AF-A	1/8"
7A 127AF-B	1/4"
7A 127AF-C	3/8"
7A 127AF-D	1/2"
7A 127AF-E	3/4"

127A - STREET TEE FPT TO MPT TO FPT



PART #	SIZE MPT X FPT X FPT
7A 127A-A	1/8"
7A 127A-B	1/4"
7A 127A-C	3/8"
7A 127A-D	1/2"
7A 127A-E	3/4"

Brass Fittings

PRICING CODE | 7A

60A - SLEEVE



PART #	SIZE TUBE
7A 60A-2	1/8"
7A 60A-3	3/16"
7A 60A-4	1/4"
7A 60A-5	5/16"
7A 60A-6	3/8"
7A 60A-7	7/16"
7A 60A-8	1/2"
7A 60A-10	5/8"
7A 60A-12	3/4"
7A 60A-14	7/8"

60AE - INSERT FOR SOFT TUBING



PART #	SIZE TUBE
7A 60AE-4	1/4"
7A 60AE-5	5/16"
7A 60AE-6	3/8"
7A 60AE-8	1/2"
7A 60AE-10	5/8"

60AP - DELRIN SLEEVE FOR SOFT TUBING



PART #	SIZE TUBE
7A 60AP-4	1/4"
7A 60AP-5	5/16"
7A 60AP-6	3/8"
7A 60AP-8	1/2"
7A 60AP-10	5/8"

Brass Fittings

PRICING CODE | 7A

61A - NUT



PART #	SIZE TUBE
7A 61A-2	1/8"
7A 61A-3	3/16"
7A 61A-4	1/4"
7A 61A-5	5/16"
7A 61A-6	3/8"
7A 61A-7	7/16"
7A 61A-8	1/2"
7A 61A-10	5/8"
7A 61A-12	3/4"
7A 61A-14	7/8"

62BH - BULKHEAD UNION TUBE TO TUBE



PART #	SIZE TUBE X TUBE
7A 62BH-4	1/4"
7A 62BH-6	3/8"

Brass Fittings

PRICING CODE

7A

62A - UNION TUBE TO TUBE



PART #	SIZE TUBE X TUBE
7A 62A-22	1/8" X 1/8"
7A 62A-33	3/16" X 3/16"
7A 62A-42	1/4" X 1/8"
7A 62A-43	1/4" X 3/16"
7A 62A-44	1/4" X 1/4"
7A 62A-54	5/16" X 1/4"
7A 62A-55	5/16" X 5/16"
7A 62A-64	3/8" X 1/4"
7A 62A-65	3/8" X 5/16"
7A 62A-66	3/8" X 3/8"
7A 62A-77	7/16" X 7/16"
7A 62A-86	1/2" X 3/8"
7A 62A-88	1/2" X 1/2"
7A 62A-106	5/8" X 3/8"
7A 62A-108	5/8" X 1/2"
7A 62A-1010	5/8" X 5/8"
7A 62A-1212	3/4" X 3/4"
7A 62A-1414	7/8" X 7/8"

63A - CHECK VALVE TUBE TO MPT



PART #	SIZE TUBE X MPT
7A 63A-2A	1/8" X 1/8"
7A 63A-4A	1/4" X 1/8"
7A 63A-6B	3/8" X 1/4"

Brass Fittings

PRICING CODE

7A

64A - TEE TUBE ALL ENDS



PART #	SIZE TUBE X TUBE X TUBE
7A 64A-22	1/8" X 1/8" X 1/8"
7A 64A-33	3/16" X 3/16" X 3/16"
7A 64A-44	1/4" X 1/4" X 1/4"
7A 64AF-44*	1/4" X 1/4" X 1/4"
7A 64A-55	5/16" X 5/16" X 5/16"
7A 64A-664	3/8" X 3/8" X 1/4"
7A 64A-66	3/8" X 3/8" X 3/8"
7A 64AF-66*	3/8" X 3/8" X 3/8"
7A 64A-88	1/2" X 1/2" X 1/2"
7A 64AF-88*	1/2" X 1/2" X 1/2"
7A 64A-1010	5/8" X 5/8" X 5/8"
7A 64A-1212	3/4" X 3/4" X 3/4"
7A 64A-1414	7/8" X 7/8" X 7/8"

* FORGED

65A - ELBOW TUBE BOTH ENDS



PART #	SIZE TUBE X TUBE
7A 65A-22	1/8" X 1/8"
7A 65A-33	3/16" X 3/16"
7A 65A-44	1/4" X 1/4"
7A 65AF-44*	1/4" X 1/4"
7A 65A-55	5/16" X 5/16"
7A 65AF-66*	3/8" X 3/8"
7A 65A-88	1/2" X 1/2"
7A 65A-1010	5/8" X 5/8"
7A 65A-1212	3/4" X 3/4"
7A 65A-1414	7/8" X 7/8"

* FORGED

Brass Fittings

PRICING CODE

7A

66A - CONNECTOR TUBE TO FPT



PART #	SIZE TUBE X FPT
7A 66A-2A	1/8" X 1/8"
7A 66A-3A	3/16" X 1/8"
7A 66A-3B	3/16" X 1/4"
7A 66A-4A	1/4" X 1/8"
7A 66A-4B	1/4" X 1/4"
7A 66A-4C	1/4" X 3/8"
7A 66A-4D	1/4" X 1/2"
7A 66A-5A	5/16" X 1/8"
7A 66A-5B	5/16" X 1/4"
7A 66A-6A	3/8" X 1/8"
7A 66A-6B	3/8" X 1/4"
7A 66A-6C	3/8" X 3/8"
7A 66A-6D	3/8" X 1/2"
7A 66A-8B	1/2" X 1/4"
7A 66A-8C	1/2" X 3/8"
7A 66A-8D	1/2" X 1/2"
7A 66A-10C	5/8" X 3/8"
7A 66A-10D	5/8" X 1/2"
7A 66A-10E	5/8" X 3/4"
7A 66A-12E	3/4" X 3/4"
7A 66A-14E	7/8" X 3/4"

68A - CONNECTOR TUBE TO MPT

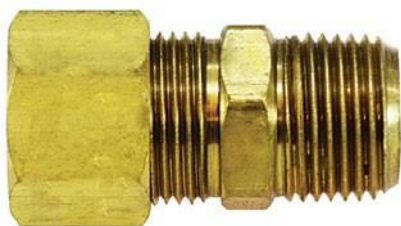

PART #	SIZE TUBE X MPT
7A 68A-2A	1/8" X 1/8"
7A 68A-3A	3/16" X 1/8"
7A 68A-3B	3/16" X 1/4"
7A 68A-4A	1/4" X 1/8"
7A 68A-4B	1/4" X 1/4"
7A 68A-4C	1/4" X 3/8"
7A 68A-4D	1/4" X 1/2"

Continued on next page...

Brass Fittings

PRICING CODE

7A

68A - CONNECTOR TUBE TO MPT *continued*

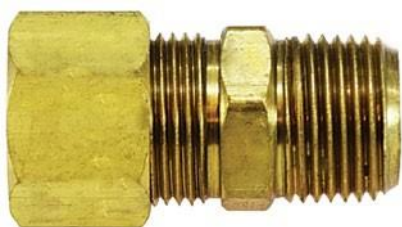

PART #	SIZE TUBE X MPT
7A 68A-5A	5/16" X 1/8"
7A 68A-5B	5/16" X 1/4"
7A 68A-5C	5/16" X 3/8"
7A 68A-6A	3/8" X 1/8"
7A 68A-6B	3/8" X 1/4"
7A 68A-6C	3/8" X 3/8"
7A 68A-6D	3/8" X 1/2"
7A 68A-6E	3/8" X 3/4"
7A 68A-7B	7/16" X 1/4"
7A 68A-7C	7/16" X 3/8"
7A 68A-8B	1/2" X 1/4"
7A 68A-8C	1/2" X 3/8"
7A 68A-8D	1/2" X 1/2"
7A 68A-8E	1/2" X 3/4"
7A 68A-10C	5/8" X 3/8"
7A 68A-10D	5/8" X 1/2"
7A 68A-10E	5/8" X 3/4"
7A 68A-12D	3/4" X 1/2"
7A 68A-12E	3/4" X 3/4"
7A 68A-14E	7/8" X 3/4"

68ATS - CONNECTOR DRILLED THRU



PART #	SIZE TUBE X MPT
7A 68ATS-4A	1/4" X 1/8"
7A 68ATS-4B	1/4" X 1/4"
7A 68ATS-6B	3/8" X 1/4"
7A 68ATS-6C	3/8" X 3/8"
7A 68ATS-6D	3/8" X 1/2"
7A 68ATS-8C	1/2" X 3/8"
7A 68ATS-8D	1/2" X 1/2"
7A 68ATS-10D	5/8" X 1/2"

Brass Fittings

PRICING CODE

7A

69A - ELBOW TUBE TO MPT

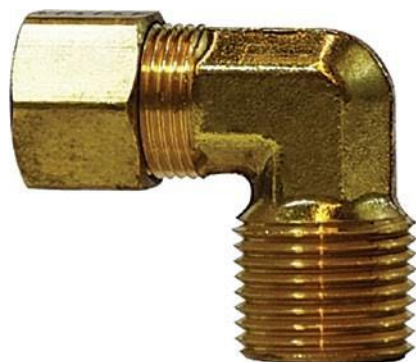

PART #	SIZE TUBE X MPT
7A 69A-2A	1/8" X 1/8"
7A 69A-3A	3/16" X 1/8"
7A 69AF-3A*	3/16" X 1/8"
7A 69A-3B	3/16" X 1/4"
7A 69A-4A	1/4" X 1/8"
7A 69AF-4A*	1/4" X 1/8"
7A 69A-4B	1/4" X 1/4"
7A 69AF-4B*	1/4" X 1/4"
7A 69A-4C	1/4" X 3/8"
7A 69A-4D	1/4" X 1/2"
7A 69A-5A	5/16" X 1/8"
7A 69AF-5A*	5/16" X 1/8"
7A 69A-5B	5/16" X 1/4"
7A 69AF-5B*	5/16" X 1/4"
7A 69A-5C	5/16" X 3/8"
7A 69A-6A	3/8" X 1/8"
7A 69A-6B	3/8" X 1/4"
7A 69AF-6B*	3/8" X 1/4"
7A 69A-6C	3/8" X 3/8"
7A 69AF-6C*	3/8" X 3/8"
7A 69A-6D	3/8" X 1/2"
7A 69A-6E	3/8" X 12"
7A 69A-7B	7/16" X 1/4"
7A 69A-8B	1/2" X 1/4"
7A 69A-8C	1/2" X 3/8"
7A 69AF-8C*	1/2" X 3/8"
7A 69A-8D	1/2" X 1/2"
7A 69A-8E	1/2" X 3/4"
7A 69A-10C	5/8" X 3/8"
7A 69A-10D	5/8" X 1/2"
7A 69A-10E	5/8" X 3/4"
7A 69A-12D	3/4" X 1/2"
7A 69A-12E	3/4" X 3/4"
7A 69A-14E	7/8" X 3/4"

* FORGED

Brass Fittings

PRICING CODE | 7A

70A - ELBOW TUBE TO FPT



PART #	SIZE TUBE X FPT
7A 70A-2A	1/8" X 1/8"
7A 70A-3A	3/16" X 1/8"
7A 70A-4A	1/4" X 1/8"
7A 70A-4B	1/4" X 1/4"
7A 70A-5A	5/16" X 1/8"
7A 70A-5B	5/16" X 1/4"
7A 70A-6A	3/8" X 1/8"
7A 70A-6B	3/8" X 1/4"
7A 70A-6C	3/8" X 3/8"
7A 70A-6D	3/8" X 1/2"
7A 70A-8B	1/2" X 1/4"
7A 70A-8C	1/2" X 3/8"
7A 70A-8D	1/2" X 1/2"
7A 70A-8E	1/2" X 3/4"
7A 70A-10D	5/8" X 1/2"
7A 70A-10E	5/8" X 3/4"
7A 70A-12D	3/4" X 1/2"

71A - MALE RUN TEE TUBE TO MPT TO TUBE

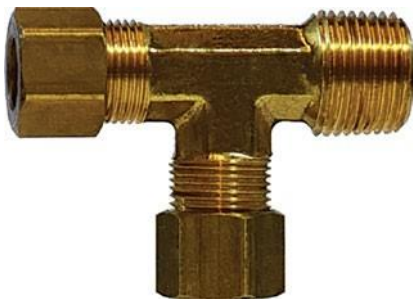

PART #	SIZE TUBE X MPT X TUBE
7A 71A-2A	1/8" X 1/8" X 1/8"
7A 71A-3A	3/6" X 1/8" X 3/16"
7A 71A-4A	1/4" X 1/8" X 1/4"
7A 71A-4B	1/4" X 1/4" X 1/4"
7A 71A-5A	5/16" X 1/8" X 5/16"
7A 71A-6A	3/8" X 1/8" X 3/8"
7A 71A-6B	3/8" X 1/4" X 3/8"
7A 71A-6C	3/8" X 3/8" X 3/8"
7A 71A-8C	1/2" X 3/8" X 1/2"
7A 71A-8D	1/2" X 1/2" X 1/2"
7A 71A-10D	5/8" X 1/2" X 5/8"
7A 71A-12D	3/4" X 1/2" X 3/4"

Brass Fittings

PRICING CODE

7A

72A - MALE BRANCH TEE TUBE TO TUBE TO MPT



PART #	SIZE TUBE X TUBE X MPT
7A 72A-3A	3/16" X 3/16" X 1/8"
7A 72A-4A	1/4" X 1/4" X 1/8"
7A 72A-4B	1/4" X 1/4" X 1/4"
7A 72A-5A	5/16" X 5/16" X 1/8"
7A 72A-5B	5/16" X 5/16" X 1/4"
7A 72A-6A	3/8" X 3/8" X 1/8"
7A 72A-6B	3/8" X 3/8" X 1/4"
7A 72A-6C	3/8" X 3/8" X 3/8"
7A 72A-8C	1/2" X 1/2" X 3/8"
7A 72A-8D	1/2" X 1/2" X 1/2"
7A 72A-10D	5/8" X 5/8" X 1/2"
7A 72A-12D	3/4" X 3/4" X 1/2"
7A 72A-12E	3/4" X 3/4" X 3/4"

76A - STREET TEE FPT TO MPT TO TUBE



PART #	SIZE FPT X MPT X TUBE
7A 76A-2A	1/8" X 1/8" X 1/8"
7A 76A-4A	1/4" X 1/8" X 1/8"
7A 76A-4B	1/4" X 1/4" X 1/4"
7A 76A-6B	3/8" X 1/4" X 1/4"

N5CT - COMPRESSION CAP



PART #	SIZE TUBE
7A N5CT-4	1/4"
7A N5CT-6	3/8"
7A N5CT-8	1/2"

Brass Fittings

PRICING CODE

7A

W1 - WATER INLET ASSY. GARDEN HOSE SWIVEL TO MPT



PART #	SIZE HOSE SWIVEL X MPT
7A W1-B	3/4" X 1/4"
7A W1-C	3/4" X 3/8"
7A W1-D	3/4" X 1/2"

W1 - WATER INLET ASSY. GARDEN HOSE TO FLARE



PART #	SIZE HOSE X FLARE
7A W1-6	3/4" X 3/8"
7A W1-8	3/4" X 1/2"

GHN1 - GARDEN HOSE NUT



PART #	SIZE
7A GHN1	3/4" Round
7A GHN1H	3/4" Hex

GHN5 - GARDEN HOSE CAP



PART #	SIZE
7A GHN5	3/4" Round

Brass Fittings

PRICING CODE

7A

5A - FEMALE HOSE TO FEMALE PIPE



PART #	SIZE FEMALE HOSE X FIP
7A 5A-12B	3/4" X 1/4"
7A 5A-12D	3/4" X 1/2"
7A 5A-12E	3/4" X 3/4"

5AS - FEMALE HOSE TO FEMALE PIPE, SWIVEL



PART #	SIZE FEMALE HOSE X FIP SWIVEL
7A 5AS-12D	3/4" X 1/2"
7A 5AS-12E	3/4" X 3/4"

18A - MALE HOSE TO FEMALE PIPE



PART #	SIZE MALE HOSE X FIP
7A 18A-12D	3/4" X 1/2"
7A 18A-12E	3/4" X 3/4"

19A - MALE HOSE TO MALE PIPE



PART #	SIZE MALEHOSE X MIP
7A 19A-12C	3/4" X 3/8"
7A 19A-12D	3/4" X 1/2"
7A 19AF-12DE	3/4" X 3/4" X 1/2"

Brass Fittings

PRICING CODE 7A

20A - FEMALE HOSE TO MALE PIPE



PART #	SIZE FEMALE HOSE X MIP
7A 20A-12C	3/4" X 3/8"
7A 20A-12D	3/4" X 1/2"
7A 20A-12E	3/4" X 3/4"

21A - HOSE "Y"



PART #	SIZE
7A 21A-12	3/4" X 3/4" X 3/4"

22A - FEMALE HOSE TO FEMALE HOSE



PART #	SIZE FEMALE HOSE
7A 22A-12	3/4" X 3/4"

GSU - FEMALE HOSE TO FEMALE HOSE, SWIVEL



PART #	SIZE FEMALE HOSE
7A GSU-12	3/4" X 3/4"

Brass Fittings

PRICING CODE 7A

23A - MALE HOSE TO MALE HOSE



PART #	SIZE MALE HOSE
7A 23A-12	3/4" X 3/4"

201GH - HOSE BARB TO GARDEN HOSE, MALE



PART #	SIZE HB X HOSE MALE
7A 201GH-6E	3/8" X 3/4"
7A 201GH-8E	1/2" X 3/4"
7A 201GH-10E	5/8" X 3/4"
7A 201GH-12E	3/4" X 3/4"

202GHS - HOSE BARB TO GARDEN HOSE SWIVEL SET



PART #	SIZE HB X HOSE SWIVEL
7A 202GHS-6E	3/8" X 3/8"
7A 202GHS-8E	1/2" X 1/2"
7A 202GHS-1010	5/8" X 5/8"
7A 202GHS-1212	3/4" X 3/4"

209GHS - HOSE BARB TO GARDEN HOSE SWIVEL



PART #	SIZE HB X HOSE SWIVEL
7A 209GHS-6E	3/8" X 3/4"
7A 209GHS-8E	1/2" X 3/4"
7A 209GHS-10E	5/8" X 3/4"
7A 209GHS-12E	3/4" X 3/4"

**THIS PAGE IS
INTENTIONALLY
LEFT BLANK**

Schedule 80 Polypropylene Pipe Fittings

PRICING CODE | 8T

The Polypropylene Pipe Fitting has a working pressure up to 15 PSI at 70°F. It is available in Heavy Duty (Schedule 80) and precision molded NPT Threads. The pipe fitting is manufactured with reinforced polypropylene, lightweight with high strength, and excellent chemical resistance.

FEATURES:

- Glass reinforced polypropylene
- Heavy duty (Schedule 80)
- Lightweight with excellent strength
- NPT threads
- Excellent chemical resistance

POLY PIPE TEE



PART #	SIZE
8T TEE025	1/4"
8T TEE0375	3/8"
8T TEE050	1/2"
8T TEE075	3/4"
8T TEE100	1"
8T TEE125	1-1/4"
8T TEE150	1-1/2"
8T TEE200	2"
8T TEE300	3"

POLY PIPE ELBOW 90



PART #	SIZE
8T EL025-90	1/4"
8T EL050-90	1/2"
8T EL075-90	3/4"
8T EL100-90	1"
8T EL125-90	1-1/4"
8T EL150-90	1-1/2"
8T EL200-90	2"
8T EL300-90	3"

Schedule 80 Polypropylene Pipe Fittings

PRICING CODE

8T

POLY REDUCER BUSHING



PART #	SIZE
8T RB038-025	3/8" X 1/4"
8T RB050-025	1/2" X 1/4"
8T RB050-0375	1/2" X 3/8"
8T RB075-025	3/4" X 1/4"
8T RB075-0375	3/4" X 3/8"
8T RB075-050	3/4" X 1/2"
8T RB100-025	1" X 1/4"
8T RB100-050	1" X 1/2"
8T RB100-075	1" X 3/4"
8T RB125-075	1-1/4" X 3/4"
8T RB125-100	1-1/4" X 1"
8T RB150-075	1-1/2" X 3/4"
8T RB150-100	1-1/2" X 1"
8T RB150-125	1-1/2" X 1-1/4"
8T RB200-075	2" X 3/4"
8T RB200-100	2" X 1"
8T RB200-125	2" X 1-1/4"
8T RB200-150	2" X 1-1/2"
8T RB300-150	3" X 1-1/2"
8T RB300-200	3" X 2"
8T RB400-300	4" X 3"

POLY CROSS



PART #	SIZE
8T CR075	3/4"
8T CR100	1"
8T CR125	1-1/4"
8T CR150	1-1/2"
8T CR200	2"

Schedule 80 Polypropylene Pipe Fittings

PRICING CODE | 8T

POLY PIPE COUPLING



PART #	SIZE
8T CPLG025	1/4"
8T CPLG0375	3/8"
8T CPLG050	1/2"
8T CPLG075	3/4"
8T CPLG100	1"
8T CPLG125	1-1/4"
8T CPLG150	1-1/2"
8T CPLG200	2"
8T CPLG300	3"

POLY REDUCER COUP.



PART #	SIZE
8T RC100-075	1" X 3/4"
8T RC150-100	1-1/2" X 1"
8T RC150-125	1-1/2" X 1-1/4"
8T RC200-100	2" X 1"
8T RC200-125	2" X 1-1/4"
8T RC200-150	2" X 1-1/2"
8T RC300-200	3" X 2"

POLY REDUCER NIPPLE



PART #	SIZE
8T RN050-0375	1/2" X 3/8"
8T RN075-050	3/4" X 1/2"
8T RN100-050	1" X 1/2"
8T RN100-075	1" X 3/4"
8T RN125-075	1-1/4" X 3/4"
8T RN125-100	1-1/4" X 1"
8T RN150-100	1-1/2" X 1"
8T RN150-125	1-1/2" X 1-1/4"
8T RN200-125	2" X 1-1/4"
8T RN200-150	2" X 1-1/2"
8T RN300-200	3" X 2"

Schedule 80 Polypropylene Pipe Fittings

PRICING CODE

8T

POLY PIPE NIPPLE



PART #	SIZE
8T NIP0375-SHORT	3/8" X SHORT
8T NIP050-SHORT	1/2" X SHORT
8T NIP050-3	1/2" X 3"
8T NIP075-SHORT	3/4" X SHORT
8T NIP075-4	3/4" X 4"
8T NIP075-6	3/4" X 6"
8T NIP100-SHORT	1" X SHORT
8T NIP100-4	1" X 4"
8T NIP100-6	1" X 6"
8T NIP125-SHORT	1-1/4" SHORT
8T NIP125-4	1-1/4" X 4"
8T NIP125-6	1-1/4" X 6"
8T NIP150-SHORT	1-1/2" X SHORT
8T NIP150-3	1-1/2" X 3"
8T NIP150-4	1-1/2" X 4"
8T NIP150-5	1-1/2" X 5"
8T NIP150-6	1-1/2" X 6"
8T NIP200-SHORT	2" X SHORT
8T NIP200-4	2" X 4"
8T NIP200-6	2" X 6"
8T NIP300-SHORT	3" X SHORT
8T NIP300-4	3" X 4"
8T NIP300-6	3" X 6"
8T NIP400-SHORT	4" X SHORT

POLY PIPE PLUG



PART #	SIZE
8T PLUG050	1/2"
8T PLUG075	3/4"
8T PLUG100	1"
8T PLUG125	1-1/4"
8T PLUG150	1-1/2"
8T PLUG200	2"
8T PLUG300	3"

Schedule 80 Polypropylene Pipe Fittings

PRICING CODE | 8T

POLY STREET ELBOW 90



PART #	SIZE
8T SL0375-90	3/8"
8T SL050-90	1/2"
8T SL075-90	3/4"
8T SL100-90	1"
8T SL125-90	1-1/4"
8T SL150-90	1-1/2"
8T SL200-90	2"
8T SL300-90	3"

POLY STREET ELBOW 45



PART #	SIZE
8T SL075-45	3/4"
8T SL100-45	1"
8T SL125-45	1-1/4"
8T SL150-45	1-1/2"
8T SL200-45	2"
8T SL300-45	3"

POLY PIPE CAP



PART #	SIZE
8T CAP075	3/4"
8T CAP100	1"
8T CAP150	1-1/2"
8T CAP200	2"
8T CAP300	3"

POLY BULKHEAD FITTING EPDM GASKET



PART #	SIZE
8T TF050	1/2"
8T TF075	3/4"
8T TF100	1"
8T TF125	1-1/4"
8T TF150	1-1/2"
8T TF200	2"
8T TF300	3"

Schedule 80 Polypropylene Pipe Fittings

PRICING CODE

8T

POLY BLIND HOLE BOLTED TANK FLANGES



PART #	SIZE
8T BF075	3/4"
8T BF100	1"
8T BF150	1-1/2"
8T BF200	2"

POLY VENT CAP



PART #	SIZE
8T VC200	2"
8T VC230 W/30 MESH SCREEN	2"

THREADED POLY 150 ANSI FLANGE



PART #	SIZE
8T AF100	1"
8T AF150	1-1/2"
8T AF200	2"
8T AF300	3"
8T AF400	4"

316 Stainless Steel Hose Barbs

PRICING CODE | **7T**

FEATURES:

- 316 Stainless Steel Precision Castings
- Hex Flats



PART #	SIZE HB X NPT
7T HBSS-04-04	1/4" X 1/4"
7T HBSS-06-04	3/8" X 1/4"
7T HBSS-06-06	3/8" X 3/8"
7T HBSS-08-04	1/2" X 1/4"
7T HBSS-08-06	1/2" X 3/8"
7T HBSS-08-08	1/2" X 1/2"
7T HBSS-08-12	1/2" X 3/4"
7T HBSS-10-08	5/8" X 1/2"
7T HBSS-12-08	3/4" X 1/2"
7T HBSS-12-12	3/4" X 3/4"
7T HBSS-12-16	3/4" X 1"
7T HBSS-16-12	1" X 3/4"
7T HBSS-16-16	1" X 1"
7T HBSS-20-20	1-1/4" X 1-1/4"
7T HBSS-24-24	1-1/2" X 1-1/2"
7T HBSS-32-32	2" X 2"
7T HBSS-48-48	3" X 3"

**THIS PAGE IS
INTENTIONALLY
LEFT BLANK**

Stainless Steel Pipe Fittings

PRICING CODE

7M

I.P.S.	SIZE	TYPE 304 PART #	TYPE 316 PART #
 <p>90° ELBOW</p>	1/4"	7M S025X90EL	7M S025X90EL316
	3/8"	7M S0375X90EL	7M S0375X90EL316
	1/2"	7M S050X90EL	7M S050X90EL316
	3/4"	7M S075X90EL	7M S075X90EL316
	1"	7M S100X90EL	7M S100X90EL316
	1-1/4"	7M S125X90EL	7M S125X90EL316
	1-1/2"	7M S150X90EL	7M S150X90EL316
	2"	7M S200X90EL	7M S200X90EL316
 <p>45° ELBOW</p>	1/4"	7M S025X45EL	7M S025X45EL316
	3/8"	7M S0375X45EL	7M S0375X45EL316
	1/2"	7M S050X45EL	7M S050X45EL316
	3/4"	7M S075X45EL	7M S075X45EL316
	1"	7M S100X45EL	7M S100X45EL316
	1-1/4"	7M S125X45EL	7M S125X45EL316
	1-1/2"	7M S150X45EL	7M S150X45EL316
	2"	7M S200X45EL	7M S200X45EL316



NOTE: Above Items Available To 4"

MSS Flanges, ANSI Flanges, Buttweld Fittings Also Available

Stainless Steel Pipe Fittings

PRICING CODE

7M

I.P.S.	SIZE	TYPE 304 PART #	TYPE 316 PART #
 <p>90° STR ELBOW</p>	1/4"	7M S025X90ST/EL	7M S025X90ST/EL316
	3/8"	7M S0375X90ST/EL	7M S0375X90ST/EL316
	1/2"	7M S050X90ST/EL	7M S050X90ST/EL316
	3/4"	7M S075X90ST/EL	7M S075X90ST/EL316
	1"	7M S100X90ST/EL	7M S100X90ST/EL316
	1-1/4"	7M S125X90ST/EL	7M S125X90ST/EL316
	1-1/2"	7M S150X90ST/EL	7M S150X90ST/EL316
	2"	7M S200X90ST/EL	7M S200X90ST/EL316
 <p>TEE</p>	1/4"	7M S025T	7M S025T316
	3/8"	7M S0375T	7M S0375T316
	1/2"	7M S050T	7M S050T316
	3/4"	7M S075T	7M S075T316
	1"	7M S100T	7M S100T316
	1-1/4"	7M S125T	7M S125T316
	1-1/2"	7M S150T	7M S150T316
	2"	7M S200T	7M S200T316

NOTE: Above Items Available To 4"
MSS Flanges, ANSI Flanges, Buttweld Fittings Also Available

Stainless Steel Pipe Fittings

PRICING CODE

7M

I.P.S.	SIZE	TYPE 304 PART #	TYPE 316 PART #
 <p>STRAIGHT COUPLING</p>	1/4"	7M S025CPR	7M S025CPR316
	3/8"	7M S0375CPR	7M S0375CPR316
	1/2"	7M S050CPR	7M S050CPR316
	3/4"	7M S075CPR	7M S075CPR316
	1"	7M S100CPR	7M S100CPR316
	1-1/4"	7M S125CPR	7M S125CPR316
	1-1/2"	7M S150CPR	7M S150CPR316
	2"	7M S200CPR	7M S200CPR316
 <p>HALF COUPLING</p>	1/4"	7M S025HCPR	7M S025HCPR316
	3/8"	7M S0375HCPR	7M S0375HCPR316
	1/2"	7M S050HCPR	7M S050HCPR316
	3/4"	7M S075HCPR	7M S075HCPR316
	1"	7M S100HCPR	7M S100HCPR316
	1-1/4"	7M S125HCPR	7M S125HCPR316
	1-1/2"	7M S150HCPR	7M S150HCPR316
	2"	7M S200HCPR	7M S200HCPR316

NOTE: Above Items Available To 4"

MSS Flanges, ANSI Flanges, Buttweld Fittings Also Available

Stainless Steel Pipe Fittings

PRICING CODE | 7M

I.P.S.	SIZE	TYPE 304 PART #	TYPE 316 PART #
	1/4" x 1/8"	7M S025X0125R/CPLG	7M S025X0125R/CPLG316
	3/8" x 1/4"	7M S0375X025R/CPLG	7M S0375X025R/CPLG316
	1/2" x 1/4"	7M S050X025R/CPLG	7M S050X025R/CPLG316
	1/2" x 3/8"	7M S050X0375R/CPLG	7M S050X0375R/CPLG316
	3/4" x 1/8"	7M S075X0125R/CPLG	7M S075X0125R/CPLG316
	3/4" x 3/8"	7M S075X0375R/CPLG	7M S075X0375R/CPLG316
	3/4" x 1/2"	7M S075X050R/CLPG	7M S075X050R/CLPG316
	1" x 1/2"	7M S100X050R/CPLG	7M S100X050R/CPLG316
	1" x 3/4"	7M S100X075R/CPLG	7M S100X075R/CPLG316
	1-1/4" x 1"	7M S125X100R/CPLG	7M S125X100R/CPLG316
	1-1/2" x 1"	7M S150X100R/CPLG	7M S150X100R/CPLG316
	1-1/2" x 1-1/4"	7M S150X125R/CPLG	7M S150X125R/CPLG316
	2" x 1"	7M S200X100R/CPLG	7M S200X100R/CPLG316
	2" x 1-1/4"	7M S200X125R/CPLG	7M S200X125R/CPLG316
2" x 1-1/2"	7M S200X150R/CPLG	7M S200X150R/CPLG316	

NOTE: Above Items Available To 4"
MSS Flanges, ANSI Flanges, Buttweld Fittings Also Available

Stainless Steel Pipe Fittings

PRICING CODE 7M

I.P.S.	SIZE	TYPE 304 PART #	TYPE 316 PART #
HEX BUSHING 	1/4" x 1/8"	7M S025X0125BUSH	7M S025X0125BUSH316
	3/8" x 1/8"	7M S0375X0125BUSH	7M S0375X0125BUSH316
	3/8" x 1/4"	7M S0375X025BUSH	7M S0375X025BUSH316
	1/2" x 1/8"	7M S050X0125BUSH	7M S050X0125BUSH316
	1/2" x 1/4"	7M S050X025BUSH	7M S050X025BUSH316
	1/2" x 3/8"	7M S050X0375BUSH	7M S050X0375BUSH316
	3/4" x 1/4"	7M S075X025BUSH	7M S075X025BUSH316
	3/4" x 3/8"	7M S075X0375BUSH	7M S075X0375BUSH316
	3/4" x 1/2"	7M S075X050BUSH	7M S075X050BUSH316
	1" x 1/8"	7M S100X0125BUSH	7M S100X0125BUSH316
	1" x 1/4"	7M S100X025BUSH	7M S100X025BUSH316
	1" x 3/8"	7M S100X0375BUSH	7M S100X0375BUSH316
	1" x 1/2"	7M S100X050BUSH	7M S100X050BUSH316
	1" x 3/4"	7M S100X075BUSH	7M S100X075BUSH316
	1-1/4" x 1/4"	7M S125X025BUSH	7M S125X025BUSH316
	1-1/4" x 1/2"	7M S125X050BUSH	7M S125X050BUSH316
	1-1/4" x 3/4"	7M S125X075BUSH	7M S125X075BUSH316
	1-1/4" x 1"	7M S125X100BUSH	7M S125X100BUSH316
	1-1/2" x 1/4"	7M S150X025BUSH	7M S150X025BUSH316
	1-1/2" x 3/8"	7M S150X037BUSH	7M S150X037BUSH316
	1-1/2" x 1/2"	7M S150X050BUSH	7M S150X050BUSH316
	1-1/2" x 3/4"	7M S150X075BUSH	7M S150X075BUSH316
	1-1/2" x 1"	7M S150X100BUSH	7M S150X100BUSH316
	1-1/2" x 1-1/4"	7M S150X125BUSH	7M S150X125BUSH316
	2" x 1/4"	7M S200X025BUSH	7M S200X025BUSH316
	2" x 3/8"	7M S200X0375BUSH	7M S200X0375BUSH316
	2" x 1/2"	7M S200X050BUSH	7M S200X050BUSH316
	2" x 1"	7M S200X100BUSH	7M S200X100BUSH316
2" x 1-1/4"	7M S200X125BUSH	7M S200X125BUSH316	
2" x 1-1/2"	7M S200X150BUSH	7M S200X150BUSH316	

NOTE: Above Items Available To 4"
MSS Flanges, ANSI Flanges, Buttweld Fittings Also Available

Stainless Steel Pipe Fittings

PRICING CODE 7M

I.P.S.	SIZE	TYPE 304 PART #	TYPE 316 PART #
UNION 	1/4"	7M S025UN	7M S025UN316
	3/8"	7M S0375UN	7M S0375UN316
	1/2"	7M S050UN	7M S050UN316
	3/4"	7M S075UN	7M S075UN316
	1"	7M S100UN	7M S100UN316
	1-1/4"	7M S125UN	7M S125UN316
	1-1/2"	7M S150UN	7M S150UN316
	2"	7M S200UN	7M S200UN316
HEX PLUG 	1/4"	7M S025HEXPLUG	7M S025HEXPLUG316
	3/8"	7M S0375HEXPLUG	7M S0375HEXPLUG316
	1/2"	7M S050HEXPLUG	7M S050HEXPLUG316
	3/4"	7M S075HEXPLUG	7M S075HEXPLUG316
	1"	7M S100HEXPLUG	7M S100HEXPLUG316
	1-1/4"	7M S125HEXPLUG	7M S125HEXPLUG316
	1-1/2"	7M S150HEXPLUG	7M S150HEXPLUG316
	2"	7M S200HEXPLUG	7M S200HEXPLUG316
CAP 	1/4"	7M S025CAP	7M S025CAP316
	3/8"	7M S0375CAP	7M S0375CAP316
	1/2"	7M S050CAP	7M S050CAP316
	3/4"	7M S075CAP	7M S075CAP316
	1"	7M S100CAP	7M S100CAP316
	1-1/4"	7M S125CAP	7M S125CAP316
	1-1/2"	7M S150CAP	7M S150CAP316
	2"	7M S200CAP	7M S200CAP316

NOTE: Above Items Available To 4"
 MSS Flanges, ANSI Flanges, Buttweld Fittings Also Available

Stainless Steel Nipples

PRICING CODE **7M**

SIZE (NPT)	LENGTH	TYPE 304/304L	TYPE 316/316L
		PART #	PART #
 <p>1/4"</p>	CLOSE (7/8")	7M S025CLNP	7M S025CLNP316
	1-1/2"	7M S025X150NP	7M S025X150NP316
	2"	7M S025X200NP	7M S025X200NP316
	2-1/2"	7M S025X250NP	7M S025X250NP316
	3"	7M S025X300NP	7M S025X300NP316
	3-1/2"	7M S025X350NP	7M S025X350NP316
	4"	7M S025X400NP	7M S025X400NP316
	4-1/2"	7M S025X450NP	7M S025X450NP316
	5"	7M S025X500NP	7M S025X500NP316
	5-1/2"	7M S025X550NP	7M S025X550NP316
 <p>3/8"</p>	CLOSE (1")	7M S0375CLNP	7M S0375CLNP316
	1-1/2"	7M S0375X150NP	7M S0375X150NP316
	2"	7M S0375X200NP	7M S0375X200NP316
	2-1/2"	7M S0375X250NP	7M S0375X250NP316
	3"	7M S0375X300NP	7M S0375X300NP316
	3-1/2"	7M S0375X350NP	7M S0375X350NP316
	4"	7M S0375X400NP	7M S0375X400NP316
	4-1/2"	7M S0375X450NP	7M S0375X450NP316
	5"	7M S0375X500NP	7M S0375X500NP316
	5-1/2"	7M S0375X550NP	7M S0375X550NP316
	6"	7M S0375X600NP	7M S0375X600NP316

NOTE: Diameters Available to 4" and Lengths to 12"

Stainless Steel Nipples

PRICING CODE

7M

SIZE (NPT)	LENGTH	TYPE 304/304L	TYPE 316/316L
		PART #	PART #
 <p>1/2"</p>	CLOSE (1-1/8")	7M S050CLNP	7M S050CLNP316
	1-1/2"	7M S050X150NP	7M S050X150NP316
	2"	7M S050X200NP	7M S050X200NP316
	2-1/2"	7M S050X250NP	7M S050X250NP316
	3"	7M S050X300NP	7M S050X300NP316
	3-1/2"	7M S050X350NP	7M S050X350NP316
	4"	7M S050X400NP	7M S050X400NP316
	4-1/2"	7M S050X450NP	7M S050X450NP316
	5"	7M S050X500NP	7M S050X500NP316
	5-1/2"	7M S050X550NP	7M S050X550NP316
 <p>3/4"</p>	CLOSE (1-3/8")	7M S075CLNP	7M S075CLNP316
	1-1/2"	7M S075X150NP	7M S075X150NP316
	2"	7M S075X200NP	7M S075X200NP316
	2-1/2"	7M S075X250NP	7M S075X250NP316
	3"	7M S075X300NP	7M S075X300NP316
	3-1/2"	7M S075X350NP	7M S075X350NP316
	4"	7M S075X400NP	7M S075X400NP316
	4-1/2"	7M S075X450NP	7M S075X450NP316
	5"	7M S075X500NP	7M S075X500NP316
	5-1/2"	7M S075X550NP	7M S075X550NP316
	6"	7M S075X600NP	7M S075X600NP316

NOTE: Diameters Available to 4" and Lengths to 12"

Stainless Steel Nipples

PRICING CODE

7M

SIZE (NPT)	LENGTH	TYPE 304/304L	TYPE 316/316L
		PART #	PART #
1" 	CLOSE (1-1/2")	7M S100CLNP	7M S100CLNP316
	2"	7M S100X200NP	7M S100X200NP316
	2-1/2"	7M S100X250NP	7M S100X250NP316
	3"	7M S100X300NP	7M S100X300NP316
	3-1/2"	7M S100X350NP	7M S100X350NP316
	4"	7M S100X400NP	7M S100X400NP316
	4-1/2"	7M S100X450NP	7M S100X450NP316
	5"	7M S100X500NP	7M S100X500NP316
	5-1/2"	7M S100X550NP	7M S100X550NP316
	6"	7M S100X600NP	7M S100X600NP316
1-1/4" 	CLOSE (1-5/8")	7M S125CLNP	7M S125CLNP316
	2"	7M S125X200NP	7M S125X200NP316
	2-1/2"	7M S125X250NP	7M S125X250NP316
	3"	7M S125X300NP	7M S125X300NP316
	3-1/2"	7M S125X350NP	7M S125X350NP316
	4"	7M S125X400NP	7M S125X400NP316
	4-1/2"	7M S125X450NP	7M S125X450NP316
	5"	7M S125X500NP	7M S125X500NP316
	5-1/2"	7M S125X550NP	7M S125X550NP316
	6"	7M S125X600NP	7M S125X600NP316

NOTE: Diameters Available to 4" and Lengths to 12"

Stainless Steel Nipples

PRICING CODE | 7M

SIZE (NPT)	LENGTH	TYPE 304/304L	TYPE 316/316L
		PART #	PART #
1-1/2" 	CLOSE (1-3/4")	7M S150CLNP	7M S150CLNP316
	2"	7M S150X200NP	7M S150X200NP316
	2-1/2"	7M S150X250NP	7M S150X250NP316
	3"	7M S150X300NP	7M S150X300NP316
	3-1/2"	7M S150X350NP	7M S150X350NP316
	4"	7M S150X400NP	7M S150X400NP316
	4-1/2"	7M S150X450NP	7M S150X450NP316
	5"	7M S150X500NP	7M S150X500NP316
	5-1/2"	7M S150X550NP	7M S150X550NP316
	6"	7M S150X600NP	7M S150X600NP316
2" 	CLOSE (2")	7M S200CLNP	7M S200CLNP316
	2-1/2"	7M S200X250NP	7M S200X250NP316
	3"	7M S200X300NP	7M S200X300NP316
	3-1/2"	7M S200X350NP	7M S200X350NP316
	4"	7M S200X400NP	7M S200X400NP316
	4-1/2"	7M S200X450NP	7M S200X450NP316
	5"	7M S200X500NP	7M S200X500NP316
	5-1/2"	7M S200X550NP	7M S200X550NP316
	6"	7M S200X600NP	7M S200X600NP316

NOTE: Diameters Available to 4" and Lengths to 12"

Stainless Steel Hex Nipples & Reducing Hex Nipples

PRICING CODE **7M**

HEX NIPPLES	SIZE	TYPE 304/304L	TYPE 316/316L
		PART #	PART #
	1/8"	7M S0125HXNP304	7M S0125HXNP316
	1/4"	7M S025HXNP304	7M S025HXNP316
	3/8"	7M S0375HXNP304	7M S0375HXNP316
	1/2"	7M S050HXNP304	7M S050HXNP316
	3/4"	7M S075HXNP304	7M S075HXNP316
	1"	7M S100HXNP304	7M S100HXNP316
	1-1/4"	7M S125HXNP304	7M S125HXNP316
	1-1/2"	7M S150HXNP304	7M S150HXNP316
	2"	7M S200HXNP304	7M S200HXNP316
	2-1/2"	7M S250HXNP304	7M S250HXNP316
3"	7M S300HXNP304	7M S300HXNP316	

REDUCING HEX NIPPLES	SIZE	TYPE 304/304L	TYPE 316/316L
		PART #	PART #
	1/4" X 1/8"	7M S025X0125RDHXNP304	7M S025X0125RDHXNP316
	3/8" X 1/8"	7M S0375X0125RDHXNP304	7M S0375X0125RDHXNP316
	3/8" X 1/4"	7M S0375X025RDHXNP304	7M S0375X025RDHXNP316
	1/2" X 1/8"	7M S050X0125RDHXNP304	7M S050X0125RDHXNP316
	1/2" X 1/4"	7M S050X025RDHXNP304	7M S050X025RDHXNP316
	1/2" X 3/8"	7M S050X0375RDHXNP304	7M S050X0375RDHXNP316
	3/4" X 1/4"	7M S075X025RDHXNP304	7M S075X025RDHXNP316
	3/4" X 3/8"	7M S075X0375RDHXNP304	7M S075X0375RDHXNP316
	3/4" X 1/2"	7M S075X050RDHXNP304	7M S075X050RDHXNP316
	1" X 3/8"	7M S100X0375RDHXNP304	7M S100X0375RDHXNP316
	1" X 1/2"	7M S100X050RDHXNP304	7M S100X050RDHXNP316
	1" X 3/4"	7M S100X075RDHXNP304	7M S100X075RDHXNP316
	1-1/4" X 3/4"	7M S125X075RDHXNP304	7M S125X075RDHXNP316
	1-1/4" X 1"	7M S125X100RDHXNP304	7M S125X100RDHXNP316
	1-1/2" X 3/4"	7M S150X075RDHXNP304	7M S150X075RDHXNP316
	1-1/2" X 1"	7M S150X100RDHXNP304	7M S150X100RDHXNP316
	1-1/2" X 1-1/4"	7M S150X125RDHXNP304	7M S150X125RDHXNP316
	2" X 1"	7M S200X100RDHXNP304	7M S200X100RDHXNP316
	2" X 1-1/4"	7M S200X125RDHXNP304	7M S200X125RDHXNP316
	2" X 1-1/2"	7M S200X150RDHXNP304	7M S200X150RDHXNP316

NOTE: Additional sizes and configurations available. Please call.

Spears PVC Fittings

PRICING CODE | **8X**

Specialty Sales is an authorized master distributor of the full line of PVC fittings from Spears Manufacturing. All items in their full catalog are available – please see www.spearsmfg.com. Pricing multipliers for common product lines are below.

Schedule 80 PVC Fittings	Multiplier
Code 080	0.2435
Code 083, 085	0.54
Code 086, 081, 197,	0.48
Code 901	0.60
Code 100	0.42
Schedule 40 PVC Fittings	Multiplier
Code 040	0.38
Code 047	0.54
Code 046/041	0.54
Code 043	0.52
Schedule 80 PVC Nipples	Multiplier
Code 120	0.48
PVC Insert Fittings	Multiplier
Code 140	0.45
Code 040	0.38
Schedule 80 CPVC Fittings	Multiplier
Code 090	0.2675
Code 092, 085, 097, 034, 035	0.54
Code 096, 101, 091	0.48
Code 901, 217	0.60
Valves & Accessories	Multiplier
All Codes	0.60
Schedule 80 PVC PIPE	Multiplier
Code 744	0.384
Schedule 80 CPVC PIPE	Multiplier
Code 745	0.384
Schedule 40 Clear PVC Pipe/Fittings	Multiplier
Code 742	0.612
Code 039	0.918

Please Note: Codes are located in the header of each item category.

CLAMPS STYLES

PRICING CODE	DESCRIPTION	PAGE
5F	F Series – Punch-Type Clamps	E1
5F	K Series – Universal Clamps	E2
5F	Fast-Lok Clamp-It Strapping and Buckles	E3
5F	Fast-Lok Clamping Tools & Tool Parts	E4
5I	IDEAL Worm Gear Clamps	E5
5T	TRIDON Miniature Worm Gear Clamps	E6
5I	POW'R-GEAR® 60 High Performance Clamps	E7
5X	IDEAL T-Bolt Clamps	E8
5P	Easy Seal Ny-Glass Hose Clamps	E9
5O	Oetiker 1-Ear Clamps	E11
5O	Oetiker 2-Ear Clamps	E12
5O	Oetiker StepLess® Ear Clamps	E13
5O	Oetiker Tools & Kits	E14
5G	Cable Ties	E15
7F	Brass Ferrules	E17



**THIS PAGE IS
INTENTIONALLY
LEFT BLANK**

“F” Series Punch Type Clamps

PRICING CODE | 5F

Preformed Clamps are double wrapped and formed to a given diameter. Used primarily where one end of the hose or article is free to allow the clamps to be slid over the hose end before the fitting is inserted. Preformed clamps range in size from 13/16 inch I.D. to 8 inch I.D.; all clamps may be pulled down to a smaller diameter but cannot be adjusted to a larger diameter.

Open End Clamps are of the same general construction as the preformed clamps with this exception, the double wrapping of the band around the hose or article is a part of the application. The open end clamps are used when one end or both, of the article to be clamped is not free, or an obstruction prevents slipping a preformed clamp over the end. Open End Clamps range in size from 13/16 inch I.D. to 48 inch I.D. Galvanized Preformed Clamps 2 1/2 Inch I.D. and above, and 5/8" wide open end clamps have a stainless steel lok for greater strength and rigidity.

	WIDTH	I.D.	CLAMPS / PACKAGE	GALVANIZED STEEL	STAINLESS STEEL
				PART #	PART #
 <p>PREFORMED CLAMPS</p>	3/8"	13/16"	100	5F F3	5F FS3
		1-3/8"	100	5F F311	5F FS311
	5/8"	1"	100	5F F4	5F FS4
		1-1/4"	100	5F F5	5F FS5
		1-1/2"	100	5F F6	5F FS6
		1-3/4"	100	5F F7	5F FS7
		2"	100	5F F8	5F FS8
		2-1/4"	100	5F F9	5F FS9
		2-1/2"	50	5F F10	5F FS10
		2-3/4"	50	5F F11	5F FS11
		3"	50	5F F12	5F FS12
		3-1/2"	50	5F F14	5F FS14
		4"	25	5F F16	5F FS16
		4-1/2"	25	5F F18	5F FS18
		5"	25	5F F20	5F FS20
		6"	25	5F F24	5F FS24
		7"	25	5F F28	5F FS28
8"	25	5F F32	5F FS32		
 <p>OPEN END CLAMPS</p>	3/8"	13/16"	100	5F FO3	5F FOS3
		1-3/8"	100	5F FO311	5F FOS311
	5/8"	2"	100	5F FO316	5F FOS316
		3-1/8"	100	5F FO325	5F FOS325
		2"	100	5F FO8	5F FOS8
		2-1/2"	50	5F FO10	5F FOS10
		3"	50	5F FO12	5F FOS12
		3-1/2"	50	5F FO14	5F FOS14
		4"	50	5F FO16	5F FOS16
		4-1/2"	50	5F FO18	5F FOS18
		5"	25	5F FO20	5F FOS20
		6"	25	5F FO24	5F FOS24
		7"	25	5F FO28	5F FOS28
		8"	25	5F FO32	5F FOS32
		9"	25	5F FO36	5F FOS36
		10"	25	5F FO40	5F FOS40
		12"	25	5F FO48	5F FOS48
14"	10	5F FO56	5F FOS56		
16"	10	5F FO64	5F FOS64		
20"	10	5F FO80	-		
24"	10	5F FO96	-		

* Clamps have a minimum order quantity, please call for pricing

“K” Series Universal Clamps

PRICING CODE

5F

K-Clamps may be secured by either a punch or fold-up method.

Less tension loss. Patented hole in inner band gives better internal mechanical locking after punching.

Preformed Clamps are available in sizes ranging from 13/16" to 8" I.D.'s. The 3/4" width sizes range from 2" to 8" I.D.'s. Each clamp is a double wrapped metal band formed to a given diameter. The clamp is designed to be slid over the hose end before the fitting is inserted. A punch-type or fold-up tool is then used to apply the clamp.

	WIDTH	I.D.	CLAMPS / PACKAGE	GALVANIZED STEEL	STAINLESS STEEL
				PART #	PART #
PREFORMED CLAMPS 	3/8"	13/16"	100	5F K3	5F KS3
		1-3/8"	100	5F K311	5F KS311
	5/8"	1"	100	5F K4	5F KS4
		1-1/4"	100	5F K5	5F KS5
		1-1/2"	100	5F K6	5F KS6
		1-3/4"	100	5F K7	5F KS7
		2"	100	5F K8	5F KS8
		2-1/4"	100	5F K9	5F KS9
		2-1/2"	50	5F K10	5F KS10
		2-3/4"	50	5F K11	5F KS11
		3"	50	5F K12	5F KS12
		3-1/2"	50	5F K14	5F KS14
		4"	25	5F K16	5F KS16
		4-1/2"	25	5F K18	5F KS18
		5"	25	5F K20	5F KS20
		6"	25	5F K24	5F KS24
		7"	25	5F K28	5F KS28
		8"	25	5F K32	5F KS32

* Clamps have a minimum order quantity, please call for pricing

Fast-Lok Clamp-It Strapping and Buckles

PRICING CODE | 5F

Multi-sized clamps for unknown requirements 1 inch to 30 feet, round or otherwise. Available in widths of 3/8", 1/2", 5/8", and 3/4" stainless or galvanized steel.

CLAMP-IT STRAPPING



WIDTH	THICKNESS	SHIPPING WEIGHT (LBS)	BOX QTY.	GALVANIZED STEEL	STAINLESS STEEL
				PART #	PART #
3/8"	0.025"	3.25	100'	5F SG3750	5F SS3751
1/2"	0.030"	5.38	100'	5F SG5000	5F SS5001
5/8"	0.030"	6.5	100'	5F SG6250	5F SS6251
3/4"	0.030"	8	100'	5F SG7500	5F SS7501

CLAMP-IT BUCKLES





WIDTH	SHIPPING WEIGHT / BOX (LBS)	BOX QTY.	GALVANIZED STEEL	STAINLESS STEEL
			PART #	PART #
3/8"	1	100	5F CG3750	5F CS3751
1/2"	1.9	100	5F CG5000	5F CS5001
5/8"	2.2	100	5F CG6250	5F CS6251
3/4"	2.1	50	5F CG7500	5F CS7501

Fast-Lok Clamping Tools & Tool Parts

PRICING CODE

5F

Used in the application and installation of Fast-Lok clamps.

	PART #	DESCRIPTION
 <p>Light Duty Locking Tool</p>	5F FT38	Portable hand tool used to apply Punch Type 3/8 and 5/8 Fast-Lock Clamps
 <p>Medium Duty Locking Tool</p>	5F FT40	Used to apply Punch Type 3/8 and 5/8 Fast-Lock clamps. Order mallet separately
 <p>Heavy Duty Locking Tool</p>	5F FT100	Used to apply Punch Type Fast-Lock clamps complete with 3/8" adaptor. Order mallet separately
 <p>Mallet</p>	5F FT225	Used for punching of all Fast-Lock punch type clamps
 <p>Clamp Cutter</p>	5F FT550	Used to remove clamps with minimum effort
 <p>Wind-Up Tool</p>	5F FTKS001	Used to apply fold-up clamps and continuous strapping up to 3/4" width

Replacement parts are available for tools, please call for pricing.

IDEAL Worm Gear Clamps

PRICING CODE

5I



#57 SERIES

- 1/2" Wide Stainless Steel Band and Housing
- 5/16" Hex Head Screw-Zinc Plated, Yellow Dichromate, Carbon Steel

#67-1 SERIES

- 1/2" Wide Stainless Steel Band and Housing
- 5/16" Hex Head Screw - 410 Stainless Steel

#67-4 SERIES

- 1/2" Wide 300 Marine Grade Stainless Steel Band Housing
- 5/16" Hex Head Screw - 300 Marine Grade Stainless Steel
- Pricing available on request

CLAMP SIZE	CLAMP RANGE	PCS / BOX (BOXED)	PCS / BOX (BULK)	#57 GL SERIES	#67-1 SS SERIES
				PART #	PART #
6	3/8" – 7/8"	10	500	5I 57-06G	5I 67-1-06S
8	7/16" – 1"	10	500	5I 57-08G	5I 67-1-08S
10	1/2" – 1-1/16"	10	500	5I 57-10G	5I 67-1-10S
12	1/2" – 1-1/4"	10	500	5I 57-12G	5I 67-1-12S
16	11/16" – 1-1/2"	10	500	5I 57-16G	5I 67-1-16S
20	3/4" – 1-3/4"	10	500	5I 57-20G	5I 67-1-20S
24	1" – 2"	10	500	5I 57-24G	5I 67-1-24S
28	1-1/4" – 2-1/4"	10	500	5I 57-28G	5I 67-1-28S
32	1-1/2" – 2-1/2"	10	500	5I 57-32G	5I 67-1-32S
36	1-3/4" – 2-3/4"	10	500	5I 57-36G	5I 67-1-36S
40	2" – 3"	10	500	5I 57-40G	5I 67-1-40S
44	2-1/4" – 3-1/4"	10	500	5I 57-44G	5I 67-1-44S
48	2-1/2" – 3-1/2"	10	500	5I 57-48G	5I 67-1-48S
52	2-3/4" – 3-3/4"	10	250	5I 57-52G	5I 67-1-52S
56	3" – 4"	10	250	5I 57-56G	5I 67-1-56S
64	2-1/2" – 4-1/2"	10	250	5I 57-64G	5I 67-1-64S
72	3" – 5"	10	250	5I 57-72G	5I 67-1-72S
80	3-1/2" – 5-1/2"	10	150	5I 57-80G	5I 67-1-80S
88	4" – 6"	10	150	5I 57-88G	5I 67-1-88S
96	4-1/2" – 6-1/2"	10	150	5I 57-96G	5I 67-1-96S
104	5" – 7"	10	100	5I 57-104G	5I 67-1-104S

* Part Number denoted with a "B" as the final character, e.g. 5I57-06GB

TRIDON Miniature Worm Gear Clamps

PRICING CODE

5T



300 SERIES

- 1/4" Hex Slotted Carbon Steel Screw
- 5/16" 301 Stainless Steel Band
- Carbon Steel Housing

325 SERIES

- 1/4" Hex Slotted Carbon Steel Screw
- 5/16" 301 Stainless Steel Band
- 301 Stainless Steel Housing

350 SERIES

- 1/4" Hex Slotted 301 Stainless Steel Screw
- 5/16" 301 Stainless Steel Band
- 301 Stainless Steel Housing

SIZE	DIA. RANGE		PCS / BOX (BOXED)	PCS / BOX (BULK)	S-300	S-325
	MIN	MAX			PART #	PART #
4	7/32"	5/8"	10	1000	5T 300-004	5T 325-004
5	7/16"	11/16"	10	1000	5T 300-005	5T 325-005
6	5/16"	7/8"	10	1000	5T 300-006	5T 325-006
8	7/16"	1"	10	500	5T 300-008	5T 325-008
10	1/2"	1-1/16"	10	500	5T 300-010	5T 325-010
12	9/16"	1-1/4"	10	500	5T 300-012	5T 325-012
16	11/16"	1-1/2"	10	500	5T 300-016	5T 325-016

SIZE	DIA. RANGE		PCS / BOX (BOXED)	PCS / BOX (BULK)	S-350
	MIN	MAX			PART #
4	7/32"	5/8"	10	1000	5T 350-004
5	7/16"	11/16"	10	1000	5T 350-005
6	5/16"	7/8"	10	1000	5T 350-006
8	7/16"	1"	10	500	5T 350-008
10	1/2"	1-1/16"	10	500	5T 350-010
12	9/16"	1-1/4"	10	500	5T 350-012
16	11/16"	1-1/2"	10	500	5T 350-016
20	7/8"	1-3/4"	10	500	5T 350-020

* Part number denoted with a "B" as the final character, e.g. 5T300-004B

POW'R-GEAR® 60 High Performance Clamps

PRICING CODE

5I



FEATURES:

- Designed for High Vibration and Stubborn Leakage Applications
- Extra Wide 5/8" Heavy Gauge Band and a Wide Profile Housing that Provides Maximum Engagement of Screw Threads to Band
- Engineered to deliver exceptionally high rates of band tension to handle the toughest sealing jobs.
- Installation Torque: 75 to 90 in-lbs (8.5 to 10 Nm)
- Available in additional materials, including marine grade stainless steel

APPLICATIONS:

- Industrial Machinery
- Heavy Truck
- Farm and Off-road Equipment Engines

MATERIAL SPECIFICATIONS:

- Screw: 5/16" Hex Head; 410 Stainless Steel
- Housing: 304 Stainless Steel
- Band: 5/8", 304 Stainless Steel

CLAMP SIZE	CLAMP RANGE	BOX		BULK	
		PART #	PACKAGE QTY.	PART #	PACKAGE QTY.
175	1" – 1-3/4"	5I 60175	10	5I 60175B	400
212	1-1/4" – 2-1/8"	5I 60200	10	5I 60200B	400
262	1-3/4" – 2-5/8"	5I 60250	10	5I 60250B	200
312	2-1/4" – 3-1/8"	5I 60300	10	5I 60300B	300
362	2-3/4" – 3-5/8"	5I 60350	10	5I 60350B	250
412	3-1/4" – 4-1/8"	5I 60400	10	5I 60400B	200
462	3-3/4" – 4-5/8"	5I 60450	10	5I 60450B	200
512	4-1/4" – 5-1/8"	5I 60500	10	5I 60500B	150
562	4-3/4" – 5-5/8"	5I 60550	10	5I 60550B	150
612	5-1/4" – 6-1/8"	5I 60600	10	5I 60600B	130
662	5-3/4" – 6-5/8"	5I 60650	10	5I 60650B	125
712	6-1/4" – 7-1/8"	5I 60700	10	5I 60700B	100
762	6-3/4" – 7-5/8"	5I 60750	10	5I 60750B	100
812	7-1/4" – 8-1/8"	5I 60800	10	5I 60800B	100
862	7-3/4" – 8-5/8"	5I 60850	10	5I 60850B	75
912	8-1/4" – 9-1/8"	5I 60900	10	5I 60900B	75

IDEAL T-Bolt Clamps

PRICING CODE

5X



Nominal Diameter Sized T-Bolt Clamps provide uniform sealing pressure for a positive, reliable seal. Designed for use in high vibration and large diameter applications common in heavy trucks, industrial machinery, off-road equipment, agricultural irrigation and machinery. Easy to interchange competitors part numbers.

STYLE C-S FEATURES:

- 1/4" T-Bolt in Plated Carbon Steel
- 7/16" Hex Nut in Plated Carbon Steel w/ Nylon Insert
- 3/4" Band, Bridge, and Trunnion in 301 Stainless Steel

STYLE N-S4 FEATURES:

- 1/4" T-Bolt in 304 Stainless Steel
- 7/16" Hex Nut in 304 Stainless Steel w/ Nylon Insert
- 3/4" Band, Bridge, and Trunnion in 301 Stainless Steel

SIZE	RANGE		STYLE C-S PART #	STYLE N-S4 PART #
	MIN	MAX		
1-1/2"	1-3/8"	1-18/32"	5X TBC150 C-S	5X TBC150 N-S4
1-5/8"	1-16/32"	1-22/32"	5X TBC162 C-S	5X TBC162 N-S4
1-3/4"	1-20/32"	1-28/32"	5X TBC175 C-S	5X TBC175 N-S4
1-15/16"	1-24/32"	2"	5X TBC193 C-S	5X TBC193 N-S4
2-13/64"	1-14/16"	2-3/16"	5X TBC203 C-S	5X TBC203 N-S4
2-1/8"	1-30/32"	2-8/32"	5X TBC212 C-S	5X TBC212 N-S4
2-1/4"	2"	2-10/32"	5X TBC225 C-S	5X TBC225 N-S4
2-5/16"	2-4/32"	2-14/32"	5X TBC231 C-S	5X TBC231 N-S4
2-3/8"	2-8/32"	2-18/32"	5X TBC238 C-S	5X TBC238 N-S4
2-13/32"	2-3/16"	2-1/2"	5X TBC240 C-S	5X TBC240 N-S4
2-1/2"	2-12/32"	2-22/32"	5X TBC250 C-S	5X TBC250 N-S4
2-17/32"	2-5/16"	2-5/8"	5X TBC253 C-S	5X TBC253 N-S4
2-23/32"	2-1/2"	2-52/64"	5X TBC272 C-S	5X TBC272 N-S4
3"	2-24/32"	3-2/32"	5X TBC300 C-S	5X TBC300 N-S4
3-3/32"	2-7/8"	3-12/64"	5X TBC309 C-S	5X TBC309 N-S4
3-1/4"	3"	3-10/32"	5X TBC325 C-S	5X TBC325 N-S4
3-1/2"	3-12/32"	3-22/32"	5X TBC350 C-S	5X TBC350 N-S4
3-17/32"	3-5/16"	3-5/8"	5X TBC353 C-S	5X TBC353 N-S4
3-21/32"	3-7/16"	3-3/4"	5X TBC365 C-S	5X TBC365 N-S4
3-3/4"	3-16/32"	3-26/32"	5X TBC375 C-S	5X TBC375 N-S4
4"	3-24/32"	4-4/32"	5X TBC400 C-S	5X TBC400 N-S4

Other sizes available upon request

Easy Seal Ny-Glass Hose Clamps

PRICING CODE

5P



FEATURES:

- Resistant to Oil, Gasoline, Salt Water, Fertilizers, Plating Acids, Sunlight, Ozone–Rust, Corrosion & Most Chemicals
- Able to be installed with standard pliers
- Releasable by twisting when needed
- Additional sizes not listed are available upon request

RANGE	BOX		BULK	
	PART #	PACKAGE QTY.	PART #	PACKAGE QTY.
1/4" – 5/16"	5P 016CB	100	5P 016MB	1000
11/32" – 13/32"	5P 023CB	100	5P 023MB	1000
13/32" – 15/32"	5P 026CB	100	5P 026MB	1000
15/32" – 17/32"	5P 030CB	100	5P 030MB	1000
17/32" – 19/32"	5P 032CB	100	5P 032MB	1000
19/32" – 21/32"	5P 038CB	100	5P 038MB	1000
43/64" – 13/16"	5P 044CB	100	5P 044MB	1000
3/4" – 7/8"	5P 050CB	100	5P 050MB	1000
7/8" – 1"	5P 056CB	100	5P 056MB	1000
61/64" – 1-3/32"	5P 062CB	100	5P 062MB	1000
1-1/32" – 1-3/16"	5P 068CB	100	5P 068MB	1000
1-1/4" – 1-7/16"	5P 080CB	100	5P 080MB	1000
1-13/32" – 1-5/8"	5P 092CB	100	5P 092MB	1000
1-19/32" – 1-13/16"	5P 104CB	100	5P 104MB	1000
1-25/32" – 2-1/64"	5P 114CB	100	5P 114MB	1000
1-7/8" – 2-1/8"	5P 124CB	100	5P 124MB	1000
2-1/8" – 2-3/8"	5P 134CB	100	5P 134MB	1000

* Call for Pricing

**THIS PAGE IS
INTENTIONALLY
LEFT BLANK**

Oetiker Clamps – 1 Ear Clamps

PRICING CODE 50

FEATURES:

- Clamp ear: fast and simple installation, visible deformation provides evidence of proper closure
- Dimple: increases clamping force
- Specially formed strip edges: reduced risk of damage to parts being clamped
- Prices on larger sizes available on request



SIZE	RANGE	PCS / BOX (BAG)	GALVANIZED STEEL	STAINLESS STEEL
			PART #	PART #
23/64"	0.327" – 0.398"	100	50 101	50 101R
3/8"	0.350" – 0.413"	100	50 105	50 105R
7/16"	0.382" – 0.445"	100	50 113	50 113R
15/32"	0.409" – 0.484"	100	50 123	50 123R
1/2"	0.449" – 0.524"	100	50 133	50 133R
35/64"	0.469" – 0.551"	100	50 140	50 140R
9/16"	0.496" – 0.571"	100	50 145	50 145R
5/8"	0.531" – 0.618"	100	50 157	50 157R
11/16"	0.594" – 0.669"	100	50 170	50 170R
23/32"	0.618" – 0.728"	100	50 185	50 185R
3/4"	0.669" – 0.780"	100	50 198	50 198R
13/16"	0.717" – 0.827"	100	50 210	50 210R
7/8"	0.780" – 0.890"	100	50 226	50 226R
15/16"	0.839" – 0.949"	100	50 241	50 241R
1"	0.898" – 1.008"	100	50 256	50 256R
1-1/16"	0.945" – 1.067"	100	50 271	50 271R
1-1/8"	1.004" – 1.126"	100	50 286	50 286R
1-3/16"	1.063" – 1.185"	100	50 301	50 301R
1-1/4"	1.122" – 1.244"	100	50 316	50 316R
1-5/16"	1.181" – 1.303"	100	50 331	50 331R
1-3/8"	1.240" – 1.362"	100	50 346	50 346R
1-7/16"	1.299" – 1.421"	100	50 361	50 361R
1-15/32"	1.358" – 1.480"	100	50 376	50 376R
1-1/2"	1.378" – 1.500"	100	50 381	50 381R
1-9/16"	1.437" – 1.559"	100	50 396	50 396R
1-5/8"	1.492" – 1.614"	100	50 410	50 410R

Oetiker Clamps – 2 Ear Clamps

PRICING CODE

50



FEATURES:

- 2-Ear version: extended clamping range
- Compact one-piece clamp: for robust, secure connections
- Clamp ear: fast and simple installation, visible deformation provides evidence of proper closure
- Deburred edges: reduced risk of damage to parts being clamped
- Prices on larger sizes available on request

SIZE	RANGE	WIDTH	PCS / BOX (BAG)	GALVANIZED STEEL	STAINLESS STEEL
				PART #	PART #
5/32"	0.122" – 0.161"	0.138"	100	5O 0041	5O 0041R
11/64"	0.138" – 0.177"	0.138"	100	5O 0045	5O 0045R
3/16"	0.134" – 0.197"	0.197"	100	5O 0305	5O 0305R
1/4"	0.197" – 0.276"	0.236"	100	5O 0507	5O 0507R
5/16"	0.276" – 0.354"	0.276"	100	5O 0709	5O 0709R
3/8"	0.319" – 0.433"	0.276"	100	5O 0811	5O 0811R
1/2"	0.425" – 0.512"	0.276"	100	5O 1113	5O 1113R
9/16"	0.492" – 0.591"	0.295"	100	5O 1315	5O 1315R
19/32"	0.551" – 0.669"	0.315"	100	5O 1517	5O 1517R
5/8"	0.591" – 0.709"	0.315"	100	5O 1518	5O 1518R
3/4"	0.638" – 0.787"	0.335"	100	5O 1720	5O 1720R
13/16"	0.709" – 0.866"	0.354"	100	5O 1922	5O 1922R
7/8"	0.748" – 0.906"	0.354"	100	5O 2023	5O 2023R
15/16"	0.827" – 0.984"	0.394"	100	5O 2225	5O 2225R
1"	0.886" – 1.063"	0.394"	100	5O 2327	5O 2327R
1-1/16"	0.945" – 1.102"	0.394"	100	5O 2528	5O 2528R
1-1/8"	1.035" – 1.220"	0.394"	100	5O 2731	5O 2731R
1-5/16"	1.154" – 1.339"	0.394"	100	5O 3134	5O 3134R
1-7/16"	1.260" – 1.457"	0.394"	100	5O 3437	5O 3437R
1-1/2"	1.378" – 1.575"	0.394"	100	5O 3740	5O 3740R
1-5/8"	1.480" – 1.693"	0.394"	100	5O 4043	5O 4043R
1-3/4"	1.598" – 1.811"	0.394"	100	5O 4346	5O 4346R

Oetiker StepLess® Ear Clamps

PRICING CODE

50



FEATURES:

- Special design eliminates steps and/or overlaps on the inner circumference of the clamp for a 360° leak-free seal.
- Because the tongue resides in a groove, the “tongue-in-groove” feature exerts pressure on the assembled parts over 360°, enabling the clamp to apply a continuous radial force completely around the connection’s diameter.
- 360° StepLess®: uniform 360° compression and uniform surface pressure
- Narrow band: concentrates transmission of clamping force, less weight
- Clamp ear: compensates for component tolerances, adjustable surface pressure
- Dimple: increases clamping force, spring-effect compensates for changes in diameter due to thermal expansion
- Specially formed strip edges: reduced risk of damage to parts being clamped
- Prices on larger sizes available on request

SIZE	RANGE	WIDTH	PCS / BOX (BAG)	STAINLESS STEEL	
				PART #	BULK QTY
9/32"	0.228" – 0.276"	0.197"	100	50 0983	10000
5/16"	0.268" – 0.315"	0.197"	100	50 0984	10000
11/32"	0.276" – 0.343"	0.197"	100	50 0985	10000
3/8"	0.307" – 0.374"	0.197"	100	50 0986	9000
25/64"	0.327" – 0.394"	0.197"	100	50 0987	10000
13/32"	0.346" – 0.413"	0.197"	100	50 0988	8000
7/16"	0.378" – 0.445"	0.197"	100	50 0989	8000
29/64"	0.398" – 0.465"	0.197"	100	50 0990	7000
15/32"	0.386" – 0.484"	0.276"	100	50 0992	4000
1/2"	0.425" – 0.524"	0.276"	100	50 0993	4000
17/32"	0.445" – 0.543"	0.276"	100	50 0995	4000
35/64"	0.453" – 0.551"	0.276"	100	50 0997	4000
9/16"	0.472" – 0.571"	0.276"	100	50 0999	3500
5/8"	0.520" – 0.618"	0.276"	100	50 1005	3000
11/16"	0.571" – 0.669"	0.276"	100	50 1009	5000
23/32"	0.602" – 0.728"	0.276"	100	50 1015	2500
3/4"	0.654" – 0.780"	0.276"	100	50 1021	3000
13/16"	0.701" – 0.827"	0.276"	100	50 1029	2000
7/8"	0.764" – 0.890"	0.276"	100	50 1041	2500
15/16"	0.823" – 0.949"	0.276"	100	50 1058	3500
1-1/16"	0.945" – 1.067"	0.276"	100	50 1087	2500
1-1/8"	1.000" – 1.126"	0.276"	100	50 1103	2000
1-3/16"	1.059" – 1.185"	0.276"	100	50 1136	3000

* Part number denoted with a “B” as the final character, e.g. 500983B

Oetiker Tools and Kits

PRICING CODE 50

	PART #	DESCRIPTION
	50 1098-SA	Standard Jaw Pincers Single Action
	50 1098-CA	Standard Jaw Pincers Compound Action
	50 1099-CA	Side Jaw Pincers Compound Action
	50 1096/10	Heavy Duty Ratchet Pincers
	50 HCC 2000	Hand Clamp Cutter Tool
	50 SK-1098R	Stainless 2 Ear Clamp Service Kit

Cable Ties – Standard

PRICING CODE

5G



FEATURES:

- Self-locking ties are easily secured with hand or tool
- Government recognized qualified products
- Complete stock in both natural and black colors
- UL recognized = E150214
- Made of Nylon 6/6
- Self-extinguishing 94V-2
- Usable up to 185°F (85°C)
- Applicable to MIL-SPECs MS3367-4, MS3367-5, MS3367-1, MS3367-7, MS3367-2, MS3367-3, MS3367-6

NOTES:

- Standard Bags of 100 Pcs.

PART #	APPROX. WIDTH IN. (MM)	APPROX. LENGTH IN. (MM)	MAX BUNDLE DIAMETER IN. (MM)	MIN. LOOP TENSILE STRENGTH LB. (KG)
5G GT-18S1	0.10" (2.5)	3-1/8" (80)	5/8" (17)	18 (8)
5G GT-18S3	0.10" (2.5)	4" (100)	7/8" (22)	18 (8)
5G GT-18M1	0.10" (2.5)	5-5/8" (142)	1-3/8" (35)	18 (8)
5G GT-18M2	0.10" (2.5)	6-3/8" (160)	1-9/16" (40)	18 (8)
5G GT-18L	0.10" (2.5)	8" (203)	2" (50)	18 (8)
5G GT-40S	0.14" (3.6)	5-7/8" (150)	1-3/8" (35)	40 (18)
5G GT-40M	0.14" (3.6)	8" (203)	2" (50)	40 (18)
5G GT-40L	0.14" (3.6)	11-5/8" (295)	3" (77)	40 (18)
5G GT-50S1	0.19" (4.8)	6-3/8" (162)	1-9/16" (40)	50 (23)
5G GT-50S2	0.19" (4.8)	7-3/8" (188)	1-3/4" (45)	50 (23)
5G GT-50M	0.19" (4.8)	11-1/2" (292)	3" (77)	50 (23)
5G GT-50L1	0.19" (4.8)	14-1/2" (368)	4" (102)	50 (23)
5G GT-50L2	0.19" (4.8)	17" (430)	4-1/2" (115)	50 (23)
5G GT-120S	0.30" (7.6)	8" (200)	2" (57)	120 (54)
5G GT-120M	0.30" (7.6)	14-1/2" (368)	4" (102)	120 (54)
5G GT-120L	0.30" (7.6)	28" (710)	7-1/2" (190)	120 (54)
5G GT-175S	0.35" (9)	20-7/8" (530)	6" (152)	175 (9.5)
5G GT-175M	0.35" (9)	25-3/4" (655)	7-1/2" (194)	175 (9.5)
5G GT-175L1	0.35" (9)	28" (710)	8" (229)	175 (9.5)
5G GT-175L3	0.35" (9)	36" (912)	10-1/3" (263)	175 (9.5)

* Black color denoted by adding "BL" to the part number, e.g. 5GGT-18S1BL

Cable Ties – Specialized

PRICING CODE | 5G

SCREW MOUNT FEATURES:

- These screw mount ties do away with the need for separate mounting devices.
- Mount bundle secured by screw or bolt.
- Made of Nylon 6/6.

MARKER TIES FEATURES:

- These marker ties enable wrapping and identifying in one action a group of cables or wiring.
- Made of Nylon 6/6.

SCREW MOUNT TIES



PART #	APPROX. WIDTH IN. (MM)	APPROX. LENGTH IN. (MM)	SCREW SIZE NO.
5G GS-18	0.10" (2.5)	4-3/8" (110)	#4
5G GS-40	0.14" (3.6)	6-1/8" (156)	#8
5G GS-50S	0.19" (4.8)	8" (205)	#10
5G GS-50M	0.19" (4.8)	11-1/2" (300)	#10
5G GS-50L	0.19" (4.8)	14-1/2" (370)	#10
5G GS-120	0.30" (7.6)	15" (380)	1/4"

MARKER TIES



PART #	APPROX. WIDTH IN. (MM)	APPROX. LENGTH IN. (MM)	MARKING PAD SIZE L X W (IN. X IN.)
5G GM-18	0.10" (2.5)	3-7/8" (98)	1" X 0.3"
5G GM-50S	0.19" (4.8)	7-3/8" (188)	1.1" X 0.5"
5G GM-50M	0.19" (4.8)	10-5/8" (270)	1.1" X 0.5"
5G GM-50L	0.19" (4.8)	13-3/8" (340)	1.1" X 0.5"

RELEASABLE TIES



PART #	APPROX. WIDTH IN. (MM)	APPROX. LENGTH IN. (MM)
5G GR-75S	7-7/8" (200)	0.30" (7.6)
5G GR-75M	11-3/4" (300)	0.30" (7.6)

Brass Ferrules

PRICING CODE

7F



NOTE:

- Other Sizes Available Upon Request
- Use 7FFA for Aluminum Ferrules, call for pricing

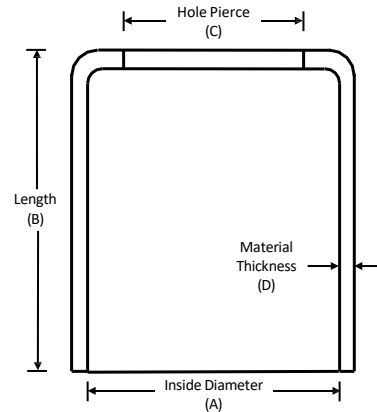

DIMENSION TOLERANCE

Dimension	Parameter	Tolerance
A	INSIDE DIAMETER	+ .005"/- .005"
B	LENGTH	+ .015"/- .015"
C	HOLE PIERCE	+ .003"/- .003"
D	MATERIAL THICKNESS	+ .003"/- .005"

PART #	A - I.D.	B - LENGTH	C - HOLE	D - METAL THICKNESS	BAG QTY
7F FB-500-L	0.500"	0.718"	0.328"	0.025"	100
7F FB-525-L	0.525"	0.718"	0.406"	0.025"	100
7F FB-550-L	0.550"	0.718"	0.406"	0.025"	100
7F FB-575-L	0.575"	0.968"	0.406"	0.025"	100
7F FB-600-L	0.600"	0.968"	0.453"	0.025"	100
7F FB-625-L	0.625"	0.968"	0.453"	0.025"	100
7F FB-650-L	0.650"	0.968"	0.453"	0.025"	100
7F FB-675-L	0.675"	0.968"	0.500"	0.025"	100
7F FB-700-L	0.700"	0.968"	0.500"	0.025"	100
7F FB-725-L	0.725"	0.968"	0.500"	0.025"	100
7F FB-750-L	0.750"	0.968"	0.500"	0.025"	100
7F FB-775-L	0.775"	0.968"	0.593"	0.025"	100

Continued on next page...

Brass Ferrules

PRICING CODE

7F



NOTE:

- Other Sizes Available Upon Request
- Use 7FFA for Aluminum Ferrules, call for pricing

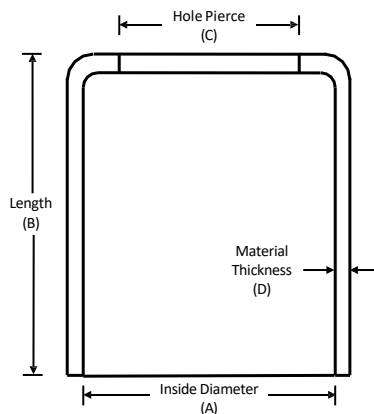

DIMENSION TOLERANCE

Dimension	Parameter	Tolerance
A	INSIDE DIAMETER	+ .005"/- .005"
B	LENGTH	+ .015"/- .015"
C	HOLE PIERCE	+ .003"/- .003"
D	MATERIAL THICKNESS	+ .003"/- .005"

PART #	A - I.D.	B - LENGTH	C - HOLE	D - METAL THICKNESS	BAG QTY
7F FB-800-L	0.800"	0.968"	0.593"	0.025"	100
7F FB-825-L	0.825"	0.968"	0.687"	0.025"	100
7F FB-850-L	0.850"	0.968"	0.687"	0.025"	100
7F FB-875-L	0.875"	0.968"	0.750"	0.025"	100
7F FB-900-L	0.900"	0.968"	0.750"	0.025"	100
7F FB-925-L	0.925"	0.968"	0.750"	0.025"	100
7F FB-950-L	0.950"	0.968"	0.750"	0.025"	100
7F FB-975-L	0.975"	0.968"	0.875"	0.040"	100
7F FB-1025-L	1.025"	0.968"	0.875"	0.040"	100
7F FB-1050-L	1.050"	0.968"	0.875"	0.040"	100
7F FB-1075-L	1.075"	0.968"	0.875"	0.040"	100
7F FB-1100-L	1.100"	0.968"	0.875"	0.040"	100

VALVES STYLES

PRICING CODE	DESCRIPTION	PAGE
6J	John Guest Polypropylene Shut-Off Valves: White	F1
6J	John Guest Polypropylene Shut-Off Valves: Black	F3
6J	John Guest Acetal Shut Off Valves: Gray	F4
6J-PL / 6J-PF	John Guest Plumbing Fitting Shut Off Valves	F5
6J	John Guest Acetal Check Valves	F6
6J	John Guest Angle Stop Adapter Valves	F7
6J-SB	Shark Bite Brass Ball Valves & Check Valves	F9
6S	Specialty Valves	F11
6R	Brass Ball Valves: Style 54 – Full Port	F53
6R	Lead Free Brass Ball Valves: Style 54 – Full Port	F54
6R	Lead Free Brass Ball Valves: Style 42 – Full Port Sweat	F55
6R	Brass Ball Valves: Style 93 – Full Port Hot-Forged Brass Exhaust Ball Valves With Lockable Handles	F56
6R	RuB Miniature Ball Valves	F57
6M	Stainless Steel Ball Valves	F59
6T	Polypropylene Ball Valves	F63
6Q	PVC Ball Valves	F65
6B	PVC Spring Check Valves	F67
6A	Needle & Misc Brass Valves	F69
6A	Shut Off Cocks	F71
6A	Drain Cocks & Drain Valves	F73

**THIS PAGE IS
INTENTIONALLY
LEFT BLANK**

John Guest Polypropylene Shut-Off Valves: White

PRICING CODE

6J

The PPSV Range of Shut-Off Valve is offered for tube sizes 1/4" O.D. and 3/8" O.D., produced in polypropylene and fitted with EPDM O-rings. Polypropylene has the advantage of being more chemically resistant than acetal. The valves are for use with potable water.

FEATURES:

- White Body with Blue Handles
- Pressure Rated 150psi
- Working Temp. 33°F - 150°F
- Food Grade Polypropylene, EPDM O-Ring & Acetal Collet
- With Stainless Steel Grippers

APPLICATIONS:

- Suitable for Medium Pressure
- Ideal for Use in Pure Water Applications

STRAIGHT PUSH-CONNECT X PUSH-CONNECT SHUT-OFF VALVES

PART #	JG PART #	DESCRIPTION	SIZE
6J V140140-GG	PPSV040808W	Straight Thru - Guest x Guest	1/4"
6J V8MM8MM-GG	PPMSV040808W	Straight Thru - Guest x Guest	5/16" x 8MM
6J V380380-GG	PPSV041212W	Straight Thru - Guest x Guest	3/8"

STRAIGHT PUSH-CONNECT X MPT SHUT-OFF VALVES

PART #	JG PART #	DESCRIPTION	SIZE
6J V140140-MG	PPSV010822W	Straight Thru - Male x Guest	1/4"
6J V380380-MG	PPSV011223W	Straight Thru - Male x Guest	3/8"

* Bulk available in 100 pieces/package, applied automatically.



John Guest

Polypropylene Shut-Off Valves: White



PRICING CODE

6J

STRAIGHT PUSH-CONNECT X FPT SHUT-OFF VALVES



PART #	JG PART #	DESCRIPTION	SIZE
6J V380380-FG	PPSV451223W	Straight Thru - Female x Guest	3/8"

ELBOW PUSH-CONNECT X FPT SHUT-OFF VALVES



PART #	JG PART #	DESCRIPTION	SIZE
6J V140140E-FG	PPSV500822W	Elbow - Female x Guest	1/4"-90
6J V380140E-FG	PPSV501222W	Elbow - Female x Guest	3/8" X 1/4"-90

MOUNTING BRACKET



PART #	JG PART #	SIZE O.D.
6J SVMC-06	SVMC-06	1/4"
6J SVMC-10	SVMC-10	3/8"

* Bulk available in 100 pieces/package, applied automatically.



John Guest

Polypropylene Shut-Off Valves: Black



PRICING CODE

6J

FEATURES:

- Black Body with Blue Handles
- Pressure Rated 150psi
- Working Temp. 33°F - 140°F
- Food Grade Polypropylene, EPDM O-Ring
- With Stainless Steel Grippers

APPLICATIONS:

- Suitable for Medium Pressure
- Ideal for Use with potable water, beverage dispensing & agricultural applications

STRAIGHT PUSH-CONNECT X PUSH-CONNECT SHUT-OFF VALVES

	PART #	JG PART #	DESCRIPTION	SIZE
	6J V140140B-GG	PPSV040808E	Straight Thru - Guest x Guest	1/4"
	6J V380380B-GG	PPSV041212E	Straight Thru - Guest x Guest	3/8"

STRAIGHT PUSH-CONNECT X FPT SHUT-OFF VALVES

	PART #	JG PART #	DESCRIPTION	SIZE
	6J V380380B-FG	PPSV451223E	Straight Thru - Guest x Female	3/8"



John Guest

Acetal Shut Off Valves: Gray



PRICING CODE

6J / 6J-PF

FEATURES:

- Working Pressures and Temperatures
- Max. 150 psi at 70°F (Max 10 bar at 20°C)
- Max 60 psi at 140°F (Max 4 bar at 60°C)
- Min. 34°F/1°C

APPLICATIONS:

Specifically manufactured in white acetal with EPDM 'O'-rings, these valves have been developed to satisfy the requirements of the US Recreational Vehicles (RV) and Mobile Home (MH) markets. The valves are for hot and cold water only.

STRAIGHT PUSH-CONNECT X PUSH-CONNECT SHUT-OFF VALVES

	PART #	JG PART #	DESCRIPTION	SIZE
	6J SHV380380-GG	PISV0412CS	Straight Thru - Guest x Guest - Short Handle	3/8"
	6J LHV380380-GG	PISV0412S	Straight Thru - Guest x Guest - Long Handle	3/8"
	6J LHV120120-GG	PISV0416S	Straight Thru - Guest x Guest - Long Handle	1/2"

STRAIGHT SHUT-OFF VALVES

	PART #	JG PART #	SIZE CTS	BAG QTY
	6J PFV120120-GG	NC2390	1/2"	1

BY-PASS VALVES

	PART #	JG PART #	SIZE CTS	BAG QTY
	6J PFV3WBP120RH	NC2391-RH	1/2"	1
	6J PFV3WBP120LH	NC2391-LH	1/2"	1

RH: Right-hand w/ gray handle. LH: Left-hand w/ black handle.



John Guest Plumbing Fitting Shut Off Valves



PRICING CODE | 6J-PL / 6J-PF

FEATURES:

- Includes indicator arrow showing off position and 2 interchangeable buttons for color coding hot & cold water.
- Firm 1/4 turn handle, prevents unwanted movement
- These valves have been designed to allow temporary servicing of downstream equipment and must only be used in the fully open or fully closed position
- UV stabilized

DO NOT USE THESE VALVES:

- In a partially open position to control flow
- To provide a permanent termination
- Without tubing assembled or plugged (or threaded connections sealed)
- As a tap or faucet

BLACK PROLOCK SHUT OFF VALVE



PART #	JG PART #	SIZE CTS	BAG QTY	BOX QTY
6J PLV120120B-GG	PSEISV20EP	1/2" X 1/2"	1	100
6J PLV340340B-GG	PSEISV28EP	3/4" X 3/4"	1	75

WHITE SPEEDFIT SHUT OFF VALVE



PART #	JG PART #	SIZE CTS	BAG QTY	BOX QTY
6J PFPPV120120-GG	PSEISV20P	1/2" X 1/2"	1	100
6J PFPPV340340-GG	PSEISV28P	3/4" X 3/4"	1	75



John Guest

Acetal Check Valves



PRICING CODE

8J

FEATURES:

- Super Speedfit Single Check Valves allow flow in one direction
- For liquids only

WHITE ACETAL



PART #	JG PART #	TUBE O.D.	CRACK PRESSURE PSI	BAG QTY	BOX QTY
8J CV140	1/4SCV	1/4"	0.3	10	300
8J CV140-5	NC2718	1/4"	5	10	300
8J CV516	5/16SCV	5/16"	0.3	10	300
8J CV380	3/8SCV	3/8"	0.3	1	80
8J CV120	1/2SCV	1/2"	1.5	10	100

BLACK ACETAL



PART #	JG PART #	TUBE O.D.	CRACK PRESSURE PSI	BAG QTY	BOX QTY
8J CV140B	NC2718E	1/4"	5	10	300

John Guest Angle Stop Adapter Valves

PRICING CODE

6J

The ASVPP Range of inch-size Angle Stop Adapter Valves is offered in white polypropylene with food grade EPDM O-rings. Our Angle Stop Adapter Valves connects between your valve and riser, to the main water supply line, for applications in Reverse Osmosis, Filtration Systems, Automatic Coffee Brewers, Ice-makers, and many more. FOR COLD WATER SUPPLY ONLY.

FEATURES:

- Lead-Free
- JG push-in connection
- Can be rotated for better positions
- 90° handle movement between on and off positions
- Polypropylene body construction
- Sturdy nickel-plated brass threads

WORKING PRESSURES AND TEMPERATURES:

150 psi at 70°F (10 bar at 20°C)

LEAD FREE BRASS

PART #	JG PART #	DESCRIPTION
6J VASLF38M38FC14	ASVPP1LF	3/8" Male Comp X 3/8" Female Comp X 1/4" Push-Connect Tube O.D.
6J VASLF38M38FC38	ASVPP2LF	3/8" Male Comp X 3/8" Female Comp X 3/8" Push-Connect Tube O.D.

LEAD FREE BRASS W/ ADAPTER

PART #	JG PART #	DESCRIPTION
6J VASLF12M12FC14	ASVPP5LF	1/2" Male/Female NPS Adapter X 1/2" Comp X 1/4" Push-Connect Tube O.D.
6J VASLF12M12FC38	ASVPP6LF	1/2" Male/Female NPS Adapter X 1/2" Comp X 3/8" Push-Connect Tube O.D.

John Guest Angle Stop Adapter Valves

PRICING CODE

6J

The PASV Range of all plastic inch size Angle Stop Valves is offered in Polypropylene with Polysulphone NPSM Male Threads. The valve is also available with a Female Conversion adapter.

FEATURES:

- Lead-Free
- JG push-in connection
- Can be rotated for better positions
- 90° handle movement between on and off positions
- Polypropylene body construction

WORKING PRESSURES AND TEMPERATURES:

145 psi at 70°F (10 bar at 20°C)

POLYPROPYLENE WITH POLYSULPHONE NPSM MALE THREADS

PART #	JG PART #	DESCRIPTION
6J VASP38M38FC14	PASVPP1	3/8" Male Comp X 3/8" Female Comp X 1/4" Push-Connect Tube O.D.
6J VASP38M38FC38	PASVPP2	3/8" Male Comp X 3/8" Female Comp X 3/8" Push-Connect Tube O.D.



POLYPROPYLENE WITH POLYSULPHONE NPSM MALE THREADS AND ADAPTER

PART #	JG PART #	DESCRIPTION
6J VASP12M12FC14	PASVPP5	1/2" Male/Female NPS Adapter X 1/2" Female Comp X 1/4" Push-Connect Tube O.D.
6J VASP12M12FC38	PASVPP6	1/2" Male/Female NPS Adapter X 1/2" Female Comp X 3/8" Push-Connect Tube O.D.

SharkBite® Brass Ball Valves and Check Valves



PRICING CODE | **6SB**

PRODUCT	PART #	SB PART #	DESCRIPTION	BAG QTY
Ball Valves				
	6SB V120SB120SB	22222-0000LF	1/2" X 1/2"	12
	6SB V340SB340SB	22185-0000LF	3/4" X 3/4"	12
	6SB V100SB100SB	22223-0000LF	1" X 1"	6
Check Valves				
	6SB CV120	U2008-0000LF	1/2" X 1/2"	6
	6SB CV340	U2016-0000LF	3/4" X 3/4"	6
	6SB CV100	U2020-0000LF	1" X 1"	3

**THIS PAGE IS
INTENTIONALLY
LEFT BLANK**

Specialty Valves: 1-Way

PRICING CODE

6S

Calculate your part number using the key below. 6S should precede your part number. (SAMPLE: 6SBRS-025-4F4F-BT)

BRS	025	4F	4F	BT
MATERIAL OPTIONS	MODEL OPTIONS	INLET OPTIONS	OUTLET OPTIONS	SEAL TYPE OPTIONS
BRS - Brass	025 - 1/4" Body 036 - 3/8" Body 050 - 1/2" Body 075 - 3/4" Body	4F - 1/4" FPT 6F - 3/8" FPT 8F - 1/2" FPT 12F - 3/4" FPT 12FGH - 3/4" Female Garden Hose	2F - 1/8" FPT 4F - 1/4" FPT 6F - 3/8" FPT 7F - 7/16" FPT 8F - 1/2" FPT 12F - 3/4" FPT 4M - 1/4" MPT 6M - 3/8" MPT 4B - 1/4" Hose Barb MN - 1/16-16 Male Nozzle Thread 12MGH - 3/4" Male Garden Hose	BT - Buna Teflon ET - EPT Teflon FT - Viton® Teflon

* Call for Quote

1-WAY FEMALE X FEMALE



PART #	BUNA TEFLON (-BT)	EPT TEFLON (-ET)	VITON® TEFLON (-FT)
6S BRS-025-4F2F	6S BRS-025-4F2F-BT	6S BRS-025-4F2F-ET	6S BRS-025-4F2F-FT
6S BRS-025-4F4F	6S BRS-025-4F4F-BT	6S BRS-025-4F4F-ET	6S BRS-025-4F4F-FT
6S BRS-025-4F7F	6S BRS-025-4F7F-BT	6S BRS-025-4F7F-ET	6S BRS-025-4F7F-FT
6S BRS-036-6F6F	6S BRS-036-6F6F-BT	6S BRS-036-6F6F-ET	6S BRS-036-6F6F-FT
6S BRS-050-8F8F	6S BRS-050-8F8F-BT	6S BRS-050-8F8F-ET	6S BRS-050-8F8F-FT
6S BRS-075-12F12F	6S BRS-075-12F12F-BT	6S BRS-075-12F12F-ET	6S BRS-075-12F12F-FT

1-WAY FEMALE X MALE



PART #	BUNA TEFLON (-BT)	EPT TEFLON (-ET)	VITON® TEFLON (-FT)
6S BRS-025-4F4M	6S BRS-025-4F4M-BT	6S BRS-025-4F4M-ET	6S BRS-025-4F4M-FT
6S BRS-036-6F6M	6S BRS-036-6F6M-BT	6S BRS-036-6F6M-ET	6S BRS-036-6F6M-FT

1-WAY FEMALE X HOSE BARB



PART #	BUNA TEFLON (-BT)	EPT TEFLON (-ET)	VITON® TEFLON (-FT)
6S BRS-025-4F4B	6S BRS-025-4F4B-BT	6S BRS-025-4F4B-ET	6S BRS-025-4F4B-FT

Specialty Valves: 1-Way

PRICING CODE

6S

1-WAY FEMALE X MALE GARDEN HOSE



PART #	BUNA TEFLON (-BT)	EPT TEFLON (-ET)	VITON® TEFLON (-FT)
6S BRS-075-12F12MGH	6S BRS-075-12F12MGH-BT	6S BRS-075-12F12MGH-ET	6S BRS-075-12F12MGH-FT

1-WAY FEMALE GARDEN HOSE X MALE GARDEN HOSE



PART #	BUNA TEFLON (-BT)	EPT TEFLON (-ET)	VITON® TEFLON (-FT)
6S BRS-075-12FGH12MGH	6S BRS-075-12FGH12MGH-BT	6S BRS-075-12FGH12MGH-ET	6S BRS-075-12FGH12MGH-FT

1-WAY FEMALE X MALE NOZZLE THREAD



PART #	BUNA TEFLON (-BT)	EPT TEFLON (-ET)	VITON® TEFLON (-FT)
6S BRS-025-4FMN	6S BRS-025-4FMN-BT	6S BRS-025-4FMN-ET	6S BRS-025-4FMN-FT

MOUNTING BRACKET



PART #

6S MB-025

Specialty Valves: 2-Way

PRICING CODE

6S

Calculate your part number using the key below. 6S should precede your part number. (SAMPLE: 6SBRS-025-4F4F-BT)

BRS	025	4F	4F	BT
MATERIAL OPTIONS	MODEL OPTIONS	INLET OPTIONS	OUTLET OPTIONS	SEAL TYPE OPTIONS
BRS (Brass)	012 - 1/8" Body 027 - 1/4" Body 038 - 3/8" Body 052 - 1/2" Body	2F - 1/8" FPT 4F - 1/4" FPT 6F - 3/8" FPT 8F - 1/2" FPT 2M - 1/8" MPT 4M - 1/4" MPT 6M - 3/8" MPT 8M - 1/2" MPT 4B - 1/4" Hose Barb 5B - 5/16" Hose Barb 6B - 3/8" Hose Barb 4C - 1/4" Compression 6C - 3/8" Compression 4MFL - 1/4" Male Flare 6MFL - 3/8" Male Flare 4FFL - 1/4" Female Flare MN - 11/16-16 Male Nozzle Thread	2F - 1/8" FPT 4F - 1/4" FPT 6F - 3/8" FPT 8F - 1/2" FPT 2M - 1/8" MPT 4M - 1/4" MPT 6M - 3/8" MPT 8M - 1/2" MPT 4B - 1/4" Hose Barb 6B - 3/8" Hose Barb 4C - 1/4" Compression 6C - 3/8" Compression 4MFL - 1/4" Male Flare 6MFL - 3/8" Male Flare	BT - Buna Teflon ET - EPT Teflon FT - Viton® Teflon

2-WAY FEMALE X FEMALE



PART #	BUNA TEFLON (-BT)	EPT TEFLON (-ET)	VITON® TEFLON (-FT)
6S BRS-012-2F2F	6S BRS-012-2F2F-BT	6S BRS-012-2F2F-ET	6S BRS-012-2F2F-FT
6S BRS-012-4F2F	6S BRS-012-4F2F-BT	6S BRS-012-4F2F-ET	6S BRS-012-4F2F-FT
6S BRS-027-4F4F	6S BRS-027-4F4F-BT	6S BRS-027-4F4F-ET	6S BRS-027-4F4F-FT
6S BRS-038-4F4F	6S BRS-038-4F4F-BT	6S BRS-038-4F4F-ET	6S BRS-038-4F4F-FT
6S BRS-038-4F6F	6S BRS-038-4F6F-BT	6S BRS-038-4F6F-ET	6S BRS-038-4F6F-FT
6S BRS-038-6F4F	6S BRS-038-6F4F-BT	6S BRS-038-6F4F-ET	6S BRS-038-6F4F-FT
6S BRS-038-6F6F	6S BRS-038-6F6F-BT	6S BRS-038-6F6F-ET	6S BRS-038-6F6F-FT
6S BRS-052-8F8F	6S BRS-052-8F8F-BT	6S BRS-052-8F8F-ET	6S BRS-052-8F8F-FT

Specialty Valves: 2-Way

PRICING CODE

6S

2-WAY FEMALE X MALE



PART #	BUNA TEFLON (-BT)	EPT TEFLON (-ET)	VITON® TEFLON (-FT)
6S BRS-012-2F2M	6S BRS-012-2F2M-BT	6S BRS-012-2F2M-ET	6S BRS-012-2F2M-FT
6S BRS-012-4F2M	6S BRS-012-4F2M-BT	6S BRS-012-4F2M-ET	6S BRS-012-4F2M-FT
6S BRS-027-4F2M	6S BRS-027-4F2M-BT	6S BRS-027-4F2M-ET	6S BRS-027-4F2M-FT
6S BRS-027-4F4M	6S BRS-027-4F4M-BT	6S BRS-027-4F4M-ET	6S BRS-027-4F4M-FT
6S BRS-038-4F6M	6S BRS-038-4F6M-BT	6S BRS-038-4F6M-ET	6S BRS-038-4F6M-FT
6S BRS-038-6F6M	6S BRS-038-6F6M-BT	6S BRS-038-6F6M-ET	6S BRS-038-6F6M-FT
6S BRS-052-8F8M	6S BRS-052-8F8M-BT	6S BRS-052-8F8M-ET	6S BRS-052-8F8M-FT

2-WAY FEMALE X COMPRESSION



PART #	BUNA TEFLON (-BT)	EPT TEFLON (-ET)	VITON® TEFLON (-FT)
6S BRS-027-4F4C	6S BRS-027-4F4C-BT	6S BRS-027-4F4C-ET	6S BRS-027-4F4C-FT
6S BRS-027-4F6C	6S BRS-027-4F6C-BT	6S BRS-027-4F6C-ET	6S BRS-027-4F6C-FT

2-WAY FEMALE X HOSE BARB



PART #	BUNA TEFLON (-BT)	EPT TEFLON (-ET)	VITON® TEFLON (-FT)
6S BRS-027-4F4B	6S BRS-027-4F4B-BT	6S BRS-027-4F4B-ET	6S BRS-027-4F4B-FT
6S BRS-027-4F6B	6S BRS-027-4F6B-BT	6S BRS-027-4F6B-ET	6S BRS-027-4F6B-FT

2-WAY FEMALE X MALE FLARE



PART #	BUNA TEFLON (-BT)	EPT TEFLON (-ET)	VITON® TEFLON (-FT)
6S BRS-027-4F4MFL	6S BRS-027-4F4MFL-BT	6S BRS-027-4F4MFL-ET	6S BRS-027-4F4MFL-FT
6S BRS-027-4F6MFL	6S BRS-027-4F6MFL-BT	6S BRS-027-4F6MFL-ET	6S BRS-027-4F6MFL-FT

Specialty Valves: 2-Way

PRICING CODE

6S

2-WAY MALE X FEMALE



PART #	BUNA TEFLON (-BT)	EPT TEFLON (-ET)	VITON® TEFLON (-FT)
6S BRS-012-2M2F	6S BRS-012-2M2F-BT	6S BRS-012-2M2F-ET	6S BRS-012-2M2F-FT
6S BRS-012-4M2F	6S BRS-012-4M2F-BT	6S BRS-012-4M2F-ET	6S BRS-012-4M2F-FT
6S BRS-027-2M4F	6S BRS-027-2M4F-BT	6S BRS-027-2M4F-ET	6S BRS-027-2M4F-FT
6S BRS-027-4M4F	6S BRS-027-4M4F-BT	6S BRS-027-4M4F-ET	6S BRS-027-4M4F-FT
6S BRS-038-4M4F	6S BRS-038-4M4F-BT	6S BRS-038-4M4F-ET	6S BRS-038-4M4F-FT
6S BRS-038-4M6F	6S BRS-038-4M6F-BT	6S BRS-038-4M6F-ET	6S BRS-038-4M6F-FT
6S BRS-038-6M4F	6S BRS-038-6M4F-BT	6S BRS-038-6M4F-ET	6S BRS-038-6M4F-FT
6S BRS-038-6M6F	6S BRS-038-6M6F-BT	6S BRS-038-6M6F-ET	6S BRS-038-6M6F-FT

2-WAY MALE X MALE



PART #	BUNA TEFLON (-BT)	EPT TEFLON (-ET)	VITON® TEFLON (-FT)
6S BRS-012-2M2M	6S BRS-012-2M2M-BT	6S BRS-012-2M2M-ET	6S BRS-012-2M2M-FT
6S BRS-012-4M2M	6S BRS-012-4M2M-BT	6S BRS-012-4M2M-ET	6S BRS-012-4M2M-FT
6S BRS-027-2M2M	6S BRS-027-2M2M-BT	6S BRS-027-2M2M-ET	6S BRS-027-2M2M-FT
6S BRS-027-2M4M	6S BRS-027-2M4M-BT	6S BRS-027-2M4M-ET	6S BRS-027-2M4M-FT
6S BRS-027-4M2M	6S BRS-027-4M2M-BT	6S BRS-027-4M2M-ET	6S BRS-027-4M2M-FT
6S BRS-027-4M4M	6S BRS-027-4M4M-BT	6S BRS-027-4M4M-ET	6S BRS-027-4M4M-FT
6S BRS-038-6M6M	6S BRS-038-6M6M-BT	6S BRS-038-6M6M-ET	6S BRS-038-6M6M-FT

2-WAY MALE X HOSE BARB



PART #	BUNA TEFLON (-BT)	EPT TEFLON (-ET)	VITON® TEFLON (-FT)
6S BRS-027-2M4B	6S BRS-027-2M4B-BT	6S BRS-027-2M4B-ET	6S BRS-027-2M4B-FT
6S BRS-027-2M6B	6S BRS-027-2M6B-BT	6S BRS-027-2M6B-ET	6S BRS-027-2M6B-FT
6S BRS-027-4M4B	6S BRS-027-4M4B-BT	6S BRS-027-4M4B-ET	6S BRS-027-4M4B-FT
6S BRS-027-4M6B	6S BRS-027-4M6B-BT	6S BRS-027-4M6B-ET	6S BRS-027-4M6B-FT

2-WAY MALE X COMPRESSION



PART #	BUNA TEFLON (-BT)	EPT TEFLON (-ET)	VITON® TEFLON (-FT)
6S BRS-027-2M4C	6S BRS-027-2M4C-BT	6S BRS-027-2M4C-ET	6S BRS-027-2M4C-FT
6S BRS-027-2M6C	6S BRS-027-2M6C-BT	6S BRS-027-2M6C-ET	6S BRS-027-2M6C-FT
6S BRS-027-4M4C	6S BRS-027-4M4C-BT	6S BRS-027-4M4C-ET	6S BRS-027-4M4C-FT
6S BRS-027-4M6C	6S BRS-027-4M6C-BT	6S BRS-027-4M6C-ET	6S BRS-027-4M6C-FT

Specialty Valves: 2-Way

PRICING CODE

6S

2-WAY MALE X MALE FLARE



PART #	BUNA TEFLON (-BT)	EPT TEFLON (-ET)	VITON® TEFLON (-FT)
6S BRS-027-2M4MFL	6S BRS-027-2M4MFL-BT	6S BRS-027-2M4MFL-ET	6S BRS-027-2M4MFL-FT
6S BRS-027-2M6MFL	6S BRS-027-2M6MFL	6S BRS-027-2M6MFL-ET	6S BRS-027-2M6MFL-FT
6S BRS-027-4M4MFL	6S BRS-027-4M4MFL	6S BRS-027-4M4MFL-ET	6S BRS-027-4M4MFL-FT
6S BRS-027-4M6MFL	6S BRS-027-4M6MFL	6S BRS-027-4M6MFL-ET	6S BRS-027-4M6MFL-FT

2-WAY MALE FLARE X COMPRESSION



PART #	BUNA TEFLON (-BT)	EPT TEFLON (-ET)	VITON® TEFLON (-FT)
6S BRS-027-4MFL4C	6S BRS-027-4MFL4C-BT	6S BRS-027-4MFL4C-ET	6S BRS-027-4MFL4C-FT
6S BRS-027-4MFL6C	6S BRS-027-4MFL6C-BT	6S BRS-027-4MFL6C-ET	6S BRS-027-4MFL6C-FT
6S BRS-027-6MFL4C	6S BRS-027-6MFL4C-BT	6S BRS-027-6MFL4C-ET	6S BRS-027-6MFL4C-FT
6S BRS-027-6MFL6C	6S BRS-027-6MFL6C-BT	6S BRS-027-6MFL6C-ET	6S BRS-027-6MFL6C-FT

2-WAY MALE FLARE X HOSE BARB



PART #	BUNA TEFLON (-BT)	EPT TEFLON (-ET)	VITON® TEFLON (-FT)
6S BRS-027-4MFL4B	6S BRS-027-4MFL4B-BT	6S BRS-027-4MFL4B-ET	6S BRS-027-4MFL4B-FT
6S BRS-027-4MFL6B	6S BRS-027-4MFL6B-BT	6S BRS-027-4MFL6B-ET	6S BRS-027-4MFL6B-FT
6S BRS-027-6MFL4B	6S BRS-027-6MFL4B-BT	6S BRS-027-6MFL4B-ET	6S BRS-027-6MFL4B-FT
6S BRS-027-6MFL6B	6S BRS-027-6MFL6B-BT	6S BRS-027-6MFL6B-ET	6S BRS-027-6MFL6B-FT

2-WAY MALE FLARE X MALE FLARE



PART #	BUNA TEFLON (-BT)	EPT TEFLON (-ET)	VITON® TEFLON (-FT)
6S BRS-027-4MFL4MFL	6S BRS-027-4MFL4MFL-BT	6S BRS-027-4MFL4MFL-ET	6S BRS-027-4MFL4MFL-FT
6S BRS-027-4MFL6MFL	6S BRS-027-4MFL6MFL-BT	6S BRS-027-4MFL6MFL-ET	6S BRS-027-4MFL6MFL-FT
6S BRS-027-6MFL4MFL	6S BRS-027-6MFL4MFL-BT	6S BRS-027-6MFL4MFL-ET	6S BRS-027-6MFL4MFL-FT
6S BRS-027-6MFL6MFL	6S BRS-027-6MFL6MFL-BT	6S BRS-027-6MFL6MFL-ET	6S BRS-027-6MFL6MFL-FT

Specialty Valves: 2-Way

PRICING CODE

6S

2-WAY MALE FLARE X FEMALE



PART #	BUNA TEFLON (-BT)	EPT TEFLON (-ET)	VITON® TEFLON (-FT)
6S BRS-012-4MFL2F	6S BRS-012-4MFL2F-BT	6S BRS-012-4MFL2F-ET	6S BRS-012-4MFL2F-FT
6S BRS-012-6MFL2F	6S BRS-012-6MFL2F-BT	6S BRS-012-6MFL2F-ET	6S BRS-012-6MFL2F-FT
6S BRS-027-4MFL4F	6S BRS-027-4MFL4F-BT	6S BRS-027-4MFL4F-ET	6S BRS-027-4MFL4F-FT
6S BRS-027-6MFL4F	6S BRS-027-6MFL4F-BT	6S BRS-027-6MFL4F-ET	6S BRS-027-6MFL4F-FT

2-WAY MALE FLARE X MALE



PART #	BUNA TEFLON (-BT)	EPT TEFLON (-ET)	VITON® TEFLON (-FT)
6S BRS-012-4MFL2M	6S BRS-012-4MFL2M-BT	6S BRS-012-4MFL2M-ET	6S BRS-012-4MFL2M-FT
6S BRS-012-6MFL2M	6S BRS-012-6MFL2M-BT	6S BRS-012-6MFL2M-ET	6S BRS-012-6MFL2M-FT
6S BRS-027-4MFL4M	6S BRS-027-4MFL4M-BT	6S BRS-027-4MFL4M-ET	6S BRS-027-4MFL4M-FT
6S BRS-027-4MFL6M	6S BRS-027-4MFL6M-BT	6S BRS-027-4MFL6M-ET	6S BRS-027-4MFL6M-FT
6S BRS-027-6MFL4M	6S BRS-027-6MFL4M-BT	6S BRS-027-6MFL4M-ET	6S BRS-027-6MFL4M-FT
6S BRS-027-6MFL6M	6S BRS-027-6MFL6M-BT	6S BRS-027-6MFL6M-ET	6S BRS-027-6MFL6M-FT

2-WAY FEMALE FLARE X COMPRESSION



PART #	BUNA TEFLON (-BT)	EPT TEFLON (-ET)	VITON® TEFLON (-FT)
6S BRS-027-4FFL4C	6S BRS-027-4FFL4C-BT	6S BRS-027-4FFL4C-ET	6S BRS-027-4FFL4C-FT
6S BRS-027-4FFL6C	6S BRS-027-4FFL6C-BT	6S BRS-027-4FFL6C-ET	6S BRS-027-4FFL6C-FT

2-WAY FEMALE FLARE X HOSE BARB



PART #	BUNA TEFLON (-BT)	EPT TEFLON (-ET)	VITON® TEFLON (-FT)
6S BRS-027-4FFL4B	6S BRS-027-4FFL4B-BT	6S BRS-027-4FFL4B-ET	6S BRS-027-4FFL4B-FT
6S BRS-027-4FFL6B	6S BRS-027-4FFL6B-BT	6S BRS-027-4FFL6B-ET	6S BRS-027-4FFL6B-FT

2-WAY FEMALE FLARE X MALE FLARE



PART #	BUNA TEFLON (-BT)	EPT TEFLON (-ET)	VITON® TEFLON (-FT)
6S BRS-027-4FFL4MFL	6S BRS-027-4FFL4MFL-BT	6S BRS-027-4FFL4MFL-ET	6S BRS-027-4FFL4MFL-FT
6S BRS-027-4FFL6MFL	6S BRS-027-4FFL6MFL-BT	6S BRS-027-4FFL6MFL-ET	6S BRS-027-4FFL6MFL-FT

Specialty Valves: 2-Way

PRICING CODE

6S

2-WAY FEMALE FLARE X FEMALE



PART #	BUNA TEFLON (-BT)	EPT TEFLON (-ET)	VITON® TEFLON (-FT)
6S BRS-012-4FFL2F	6S BRS-012-4FFL2F-BT	6S BRS-012-4FFL2F-ET	6S BRS-012-4FFL2F-FT
6S BRS-027-4FFL4F	6S BRS-027-4FFL4F-BT	6S BRS-027-4FFL4F-ET	6S BRS-027-4FFL4F-FT

2-WAY FEMALE FLARE X MALE



PART #	BUNA TEFLON (-BT)	EPT TEFLON (-ET)	VITON® TEFLON (-FT)
6S BRS-012-4FFL2M	6S BRS-012-4FFL2M-BT	6S BRS-012-4FFL2M-ET	6S BRS-012-4FFL2M-FT
6S BRS-027-4FFL4M	6S BRS-027-4FFL4M-BT	6S BRS-027-4FFL4M-ET	6S BRS-027-4FFL4M-FT
6S BRS-027-4FFL6M	6S BRS-027-4FFL6M-BT	6S BRS-027-4FFL6M-ET	6S BRS-027-4FFL6M-FT

2-WAY COMPRESSION X FEMALE



PART #	BUNA TEFLON (-BT)	EPT TEFLON (-ET)	VITON® TEFLON (-FT)
6S BRS-012-4C2F	6S BRS-012-4C2F-BT	6S BRS-012-4C2F-ET	6S BRS-012-4C2F-FT
6S BRS-027-4C4F	6S BRS-027-4C4F-BT	6S BRS-027-4C4F-ET	6S BRS-027-4C4F-FT
6S BRS-038-6C4F	6S BRS-038-6C4F-BT	6S BRS-038-6C4F-ET	6S BRS-038-6C4F-FT
6S BRS-038-6C6F	6S BRS-038-6C6F-BT	6S BRS-038-6C6F-ET	6S BRS-038-6C6F-FT

2-WAY COMPRESSION X MALE



PART #	BUNA TEFLON (-BT)	EPT TEFLON (-ET)	VITON® TEFLON (-FT)
6S BRS-012-4C2M	6S BRS-012-4C2M-BT	6S BRS-012-4C2M-ET	6S BRS-012-4C2M-FT
6S BRS-027-4C4M	6S BRS-027-4C4M-BT	6S BRS-027-4C4M-ET	6S BRS-027-4C4M-FT
6S BRS-027-4C6M	6S BRS-027-4C6M-BT	6S BRS-027-4C6M-ET	6S BRS-027-4C6M-FT
6S BRS-038-6C6M	6S BRS-038-6C6M-BT	6S BRS-038-6C6M-ET	6S BRS-038-6C6M-FT

2-WAY COMPRESSION X COMPRESSION



PART #	BUNA TEFLON (-BT)	EPT TEFLON (-ET)	VITON® TEFLON (-FT)
6S BRS-027-4C4C	6S BRS-027-4C4C-BT	6S BRS-027-4C4C-ET	6S BRS-027-4C4C-FT
6S BRS-027-4C6C	6S BRS-027-4C6C-BT	6S BRS-027-4C6C-ET	6S BRS-027-4C6C-FT

Specialty Valves: 2-Way

PRICING CODE

6S

2-WAY COMPRESSION X HOSE BARB



PART #	BUNA TEFLON (-BT)	EPT TEFLON (-ET)	VITON® TEFLON (-FT)
6S BRS-027-4C4B	6S BRS-027-4C4B-BT	6S BRS-027-4C4B-ET	6S BRS-027-4C4B-FT
6S BRS-027-4C6B	6S BRS-027-4C6B-BT	6S BRS-027-4C6B-ET	6S BRS-027-4C6B-FT

2-WAY COMPRESSION X MALE FLARE



PART #	BUNA TEFLON (-BT)	EPT TEFLON (-ET)	VITON® TEFLON (-FT)
6S BRS-027-4C4MFL	6S BRS-027-4C4MFL-BT	6S BRS-027-4C4MFL-ET	6S BRS-027-4C4MFL-FT
6S BRS-027-4C6MFL	6S BRS-027-4C6MFL-BT	6S BRS-027-4C6MFL-ET	6S BRS-027-4C6MFL-FT

2-WAY HOSE BARB X FEMALE



PART #	BUNA TEFLON (-BT)	EPT TEFLON (-ET)	VITON® TEFLON (-FT)
6S BRS-012-4B2F	6S BRS-012-4B2F-BT	6S BRS-012-4B2F-ET	6S BRS-012-4B2F-FT
6S BRS-012-5B2F	6S BRS-012-5B2F-BT	6S BRS-012-5B2F-ET	6S BRS-012-5B2F-FT
6S BRS-012-6B2F	6S BRS-012-6B2F-BT	6S BRS-012-6B2F-ET	6S BRS-012-6B2F-FT
6S BRS-027-4B4F	6S BRS-027-4B4F-BT	6S BRS-027-4B4F-ET	6S BRS-027-4B4F-FT
6S BRS-027-5B4F	6S BRS-027-5B4F-BT	6S BRS-027-5B4F-ET	6S BRS-027-5B4F-FT
6S BRS-027-6B4F	6S BRS-027-6B4F-BT	6S BRS-027-6B4F-ET	6S BRS-027-6B4F-FT
6S BRS-038-6B4F	6S BRS-038-6B4F-BT	6S BRS-038-6B4F-ET	6S BRS-038-6B4F-FT
6S BRS-038-6B6F	6S BRS-038-6B6F-BT	6S BRS-038-6B6F-ET	6S BRS-038-6B6F-FT

2-WAY HOSE BARB X MALE



PART #	BUNA TEFLON (-BT)	EPT TEFLON (-ET)	VITON® TEFLON (-FT)
6S BRS-027-4B2M	6S BRS-027-4B2M-BT	6S BRS-027-4B2M-ET	6S BRS-027-4B2M-FT
6S BRS-027-4B4M	6S BRS-027-4B4M-BT	6S BRS-027-4B4M-ET	6S BRS-027-4B4M-FT
6S BRS-027-5B2M	6S BRS-027-5B2M-BT	6S BRS-027-5B2M-ET	6S BRS-027-5B2M-FT
6S BRS-027-5B4M	6S BRS-027-5B4M-BT	6S BRS-027-5B4M-ET	6S BRS-027-5B4M-FT
6S BRS-027-6B2M	6S BRS-027-6B2M-BT	6S BRS-027-6B2M-ET	6S BRS-027-6B2M-FT
6S BRS-027-6B4M	6S BRS-027-6B4M-BT	6S BRS-027-6B4M-ET	6S BRS-027-6B4M-FT
6S BRS-038-6B4M	6S BRS-038-6B4M-BT	6S BRS-038-6B4M-ET	6S BRS-038-6B4M-FT
6S BRS-038-6B6M	6S BRS-038-6B6M-BT	6S BRS-038-6B6M-ET	6S BRS-038-6B6M-FT

Specialty Valves: 2-Way

PRICING CODE

6S

2-WAY HOSE BARB X COMPRESSION



PART #	BUNA TEFLON (-BT)	EPT TEFLON (-ET)	VITON® TEFLON (-FT)
6S BRS-027-5B6C	6S BRS-027-5B6C-BT	6S BRS-027-5B6C-ET	6S BRS-027-5B6C-FT
6S BRS-027-6B6C	6S BRS-027-6B6C-BT	6S BRS-027-6B6C-ET	6S BRS-027-6B6C-FT

2-WAY HOSE BARB X MALE FLARE



PART #	BUNA TEFLON (-BT)	EPT TEFLON (-ET)	VITON® TEFLON (-FT)
6S BRS-027-4B4MFL	6S BRS-027-4B4MFL-BT	6S BRS-027-4B4MFL-ET	6S BRS-027-4B4MFL-FT
6S BRS-027-4B6MFL	6S BRS-027-4B6MFL-BT	6S BRS-027-4B6MFL-ET	6S BRS-027-4B6MFL-FT
6S BRS-027-5B4MFL	6S BRS-027-5B4MFL-BT	6S BRS-027-5B4MFL-ET	6S BRS-027-5B4MFL-FT
6S BRS-027-5B6MFL	6S BRS-027-5B6MFL-BT	6S BRS-027-5B6MFL-ET	6S BRS-027-5B6MFL-FT
6S BRS-027-6B4MFL	6S BRS-027-6B4MFL-BT	6S BRS-027-6B4MFL-ET	6S BRS-027-6B4MFL-FT
6S BRS-027-6B6MFL	6S BRS-027-6B6MFL-BT	6S BRS-027-6B6MFL-ET	6S BRS-027-6B6MFL-FT

2-WAY MALE NOZZLE THREAD X FEMALE



PART #	BUNA TEFLON (-BT)	EPT TEFLON (-ET)	VITON® TEFLON (-FT)
6S BRS-012-MN2F	6S BRS-012-MN2F-BT	6S BRS-012-MN2F-ET	6S BRS-012-MN2F-FT

2-WAY MALE NOZZLE THREAD X MALE



PART #	BUNA TEFLON (-BT)	EPT TEFLON (-ET)	VITON® TEFLON (-FT)
6S BRS-012-MN2M	6S BRS-012-MN2M-BT	6S BRS-012-MN2M-ET	6S BRS-012-MN2M-FT
6S BRS-027-MN2M	6S BRS-027-MN2M-BT	6S BRS-027-MN2M-ET	6S BRS-027-MN2M-FT
6S BRS-027-MN4M	6S BRS-027-MN4M-BT	6S BRS-027-MN4M-ET	6S BRS-027-MN4M-FT

Specialty Valves: 2-Way

PRICING CODE

6S

2-WAY MALE NOZZLE THREAD X COMPRESSION



PART #	BUNA TEFLON (-BT)	EPT TEFLON (-ET)	VITON® TEFLON (-FT)
6S BRS-027-MN4C	6S BRS-027-MN4C-BT	6S BRS-027-MN4C-ET	6S BRS-027-MN4C-FT
6S BRS-027-MN6C	6S BRS-027-MN6C-BT	6S BRS-027-MN6C-ET	6S BRS-027-MN6C-FT

2-WAY MALE NOZZLE THREAD X HOSE BARB



PART #	BUNA TEFLON (-BT)	EPT TEFLON (-ET)	VITON® TEFLON (-FT)
6S BRS-027-MN4B	6S BRS-027-MN4B-BT	6S BRS-027-MN4B-ET	6S BRS-027-MN4B-FT
6S BRS-027-MN6B	6S BRS-027-MN6B-BT	6S BRS-027-MN6B-ET	6S BRS-027-MN6B-FT

2-WAY MALE NOZZLE THREAD X MALE FLARE



PART #	BUNA TEFLON (-BT)	EPT TEFLON (-ET)	VITON® TEFLON (-FT)
6S BRS-027-MN4MFL	6S BRS-027-MN4MFL-BT	6S BRS-027-MN4MFL-ET	6S BRS-027-MN4MFL-FT
6S BRS-027-MN6MFL	6S BRS-027-MN6MFL-BT	6S BRS-027-MN6MFL-ET	6S BRS-027-MN6MFL-FT

Specialty Valves: Plastic Ball Valves – Series 638

PRICING CODE

6S



NOTES:

- Materials: Body, ball, handle, ends - PVC
- Buna-N seals standard, ethylene propylene or fluoroelastomer seals available.
- For Technical Assistance, please call or fax our Customer Service Department.
- NSF LISTED COMPONENT

Calculate your part number using the key below. 6S should precede your part number. (SAMPLE: 6SPVC-638-4B4B-B)

PVC	638	4B	4B	B
MATERIAL OPTIONS	MODEL OPTIONS	INLET OPTIONS	OUTLET OPTIONS	SEAL TYPE OPTIONS
PVC - Gray PVC (Standard)	638	4F - 1/4" FPT	4F - 1/4" FPT	B - Buna
WPVC - White PVC*		6F - 3/8" FPT	6F - 3/8" FPT	E - EPDM
WFP - White Poly*		8F - 1/2" FPT	8F - 1/2" FPT	F - Vitor®*
BFP - Black Poly*		2M - 1/8" MPT	2M - 1/8" MPT	
		4M - 1/4" MPT	4M - 1/4" MPT	
		6M - 3/8" MPT	6M - 3/8" MPT	
		8M - 1/2" MPT	8M - 1/2" MPT	
		4B - 1/4" Hose Barb	4B - 1/4" Hose Barb	
		6B - 3/8" Hose Barb	6B - 3/8" Hose Barb	
		8B - 1/2" Hose Barb	8B - 1/2" Hose Barb	
		4C - 1/4" Push-Connect	4C - 1/4" Push-Connect	
		6C - 3/8" Push-Connect	6C - 3/8" Push-Connect	
		TB - 3/8" to 5/8" Tapered Barb	TB - 3/8" to 5/8" Tapered Barb	
		6BIB - 3/8" Smooth Barb *	6BIB - 3/8" Smooth Barb *	

*Call for pricing

638 PVC FEMALE X FEMALE



PART #	BUNA (-B)	EPDM (-E)
6S PVC-638-4F4F	6S PVC-638-4F4F-B	6S PVC-638-4F4F-E
6S PVC-638-4F6F	6S PVC-638-4F6F-B	6S PVC-638-4F6F-E
6S PVC-638-4F8F	6S PVC-638-4F8F-B	6S PVC-638-4F8F-E
6S PVC-638-6F4F	6S PVC-638-6F4F-B	6S PVC-638-6F4F-E
6S PVC-638-6F6F	6S PVC-638-6F6F-B	6S PVC-638-6F6F-E
6S PVC-638-6F8F	6S PVC-638-6F8F-B	6S PVC-638-6F8F-E
6S PVC-638-8F4F	6S PVC-638-8F4F-B	6S PVC-638-8F4F-E
6S PVC-638-8F6F	6S PVC-638-8F6F-B	6S PVC-638-8F6F-E
6S PVC-638-8F8F	6S PVC-638-8F8F-B	6S PVC-638-8F8F-E

Specialty Valves: Plastic Ball Valves – Series 638

PRICING CODE **6S**

638 PVC FEMALE X MALE



PART #	BUNA (-B)	EPDM (-E)
6S PVC-638-4F4M	6S PVC-638-4F4M-B	6S PVC-638-4F4M-E
6S PVC-638-4F6M	6S PVC-638-4F6M-B	6S PVC-638-4F6M-E
6S PVC-638-4F8M	6S PVC-638-4F8M-B	6S PVC-638-4F8M-E
6S PVC-638-6F4M	6S PVC-638-6F4M-B	6S PVC-638-6F4M-E
6S PVC-638-6F6M	6S PVC-638-6F6M-B	6S PVC-638-6F6M-E
6S PVC-638-6F8M	6S PVC-638-6F8M-B	6S PVC-638-6F8M-E
6S PVC-638-8F4M	6S PVC-638-8F4M-B	6S PVC-638-8F4M-E
6S PVC-638-8F6M	6S PVC-638-8F6M-B	6S PVC-638-8F6M-E
6S PVC-638-8F8M	6S PVC-638-8F8M-B	6S PVC-638-8F8M-E

638 PVC FEMALE X HOSE BARB



PART #	BUNA (-B)	EPDM (-E)
6S PVC-638-4F4B	6S PVC-638-4F4B-B	6S PVC-638-4F4B-E
6S PVC-638-4F6B	6S PVC-638-4F6B-B	6S PVC-638-4F6B-E
6S PVC-638-4F8B	6S PVC-638-4F8B-B	6S PVC-638-4F8B-E
6S PVC-638-6F4B	6S PVC-638-6F4B-B	6S PVC-638-6F4B-E
6S PVC-638-6F6B	6S PVC-638-6F6B-B	6S PVC-638-6F6B-E
6S PVC-638-6F8B	6S PVC-638-6F8B-B	6S PVC-638-6F8B-E
6S PVC-638-8F4B	6S PVC-638-8F4B-B	6S PVC-638-8F4B-E
6S PVC-638-8F6B	6S PVC-638-8F6B-B	6S PVC-638-8F6B-E
6S PVC-638-8F8B	6S PVC-638-8F8B-B	6S PVC-638-8F8B-E

638 PVC FEMALE X PUSH-CONNECT



PART #	BUNA (-B)	EPDM (-E)
6S PVC-638-4F4C	6S PVC-638-4F4C-B	6S PVC-638-4F4C-E
6S PVC-638-4F6C	6S PVC-638-4F6C-B	6S PVC-638-4F6C-E
6S PVC-638-6F4C	6S PVC-638-6F4C-B	6S PVC-638-6F4C-E
6S PVC-638-6F6C	6S PVC-638-6F6C-B	6S PVC-638-6F6C-E
6S PVC-638-8F4C	6S PVC-638-8F4C-B	6S PVC-638-8F4C-E
6S PVC-638-8F6C	6S PVC-638-8F6C-B	6S PVC-638-8F6C-E

638 PVC FEMALE X TAPERED BARB



PART #	BUNA (-B)	EPDM (-E)
6S PVC-638-4FTB	6S PVC-638-4FTB-B	6S PVC-638-4FTB-E
6S PVC-638-6FTB	6S PVC-638-6FTB-B	6S PVC-638-6FTB-E
6S PVC-638-8FTB	6S PVC-638-8FTB-B	6S PVC-638-8FTB-E

Specialty Valves: Plastic Ball Valves – Series 638

PRICING CODE

6S

638 PVC MALE X FEMALE



PART #	BUNA (-B)	EPDM (-E)
6S PVC-638-2M4F	6S PVC-638-2M4F-B	6S PVC-638-2M4F-E
6S PVC-638-2M6F	6S PVC-638-2M6F-B	6S PVC-638-2M6F-E
6S PVC-638-2M8F	6S PVC-638-2M8F-B	6S PVC-638-2M8F-E
6S PVC-638-4M4F	6S PVC-638-4M4F-B	6S PVC-638-4M4F-E
6S PVC-638-4M6F	6S PVC-638-4M6F-B	6S PVC-638-4M6F-E
6S PVC-638-4M8F	6S PVC-638-4M8F-B	6S PVC-638-4M8F-E
6S PVC-638-6M4F	6S PVC-638-6M4F-B	6S PVC-638-6M4F-E
6S PVC-638-6M6F	6S PVC-638-6M6F-B	6S PVC-638-6M6F-E
6S PVC-638-6M8F	6S PVC-638-6M8F-B	6S PVC-638-6M8F-E

638 PVC MALE X MALE



PART #	BUNA (-B)	EPDM (-E)
6S PVC-638-2M2M	6S PVC-638-2M2M-B	6S PVC-638-2M2M-E
6S PVC-638-2M4M	6S PVC-638-2M4M-B	6S PVC-638-2M4M-E
6S PVC-638-2M6M	6S PVC-638-2M6M-B	6S PVC-638-2M6M-E
6S PVC-638-4M2M	6S PVC-638-4M2M-B	6S PVC-638-4M2M-E
6S PVC-638-4M4M	6S PVC-638-4M4M-B	6S PVC-638-4M4M-E
6S PVC-638-4M6M	6S PVC-638-4M6M-B	6S PVC-638-4M6M-E
6S PVC-638-6M2M	6S PVC-638-6M2M-B	6S PVC-638-6M2M-E
6S PVC-638-6M4M	6S PVC-638-6M4M-B	6S PVC-638-6M4M-E
6S PVC-638-6M6M	6S PVC-638-6M6M-B	6S PVC-638-6M6M-E

638 PVC MALE X HOSE BARB



PART #	BUNA (-B)	EPDM (-E)
6S PVC-638-2M4B	6S PVC-638-2M4B-B	6S PVC-638-2M4B-E
6S PVC-638-2M6B	6S PVC-638-2M6B-B	6S PVC-638-2M6B-E
6S PVC-638-2M8B	6S PVC-638-2M8B-B	6S PVC-638-2M8B-E
6S PVC-638-4M4B	6S PVC-638-4M4B-B	6S PVC-638-4M4B-E
6S PVC-638-4M6B	6S PVC-638-4M6B-B	6S PVC-638-4M6B-E
6S PVC-638-4M8B	6S PVC-638-4M8B-B	6S PVC-638-4M8B-E
6S PVC-638-6M4B	6S PVC-638-6M4B-B	6S PVC-638-6M4B-E
6S PVC-638-6M6B	6S PVC-638-6M6B-B	6S PVC-638-6M6B-E
6S PVC-638-6M8B	6S PVC-638-6M8B-B	6S PVC-638-6M8B-E

Specialty Valves: Plastic Ball Valves – Series 638

PRICING CODE

6S

638 PVC MALE X PUSH-CONNECT



PART #	BUNA (-B)	EPDM (-E)
6S PVC-638-2M4C	6S PVC-638-2M4C-B	6S PVC-638-2M4C-E
6S PVC-638-2M6C	6S PVC-638-2M6C-B	6S PVC-638-2M6C-E
6S PVC-638-4M4C	6S PVC-638-4M4C-B	6S PVC-638-4M4C-E
6S PVC-638-4M6C	6S PVC-638-4M6C-B	6S PVC-638-4M6C-E
6S PVC-638-6M4C	6S PVC-638-6M4C-B	6S PVC-638-6M4C-E
6S PVC-638-6M6C	6S PVC-638-6M6C-B	6S PVC-638-6M6C-E

638 PVC MALE X TAPERED BARB



PART #	BUNA (-B)	EPDM (-E)
6S PVC-638-2MTB	6S PVC-638-2MTB-B	6S PVC-638-2MTB-E
6S PVC-638-4MTB	6S PVC-638-4MTB-B	6S PVC-638-4MTB-E
6S PVC-638-6MTB	6S PVC-638-6MTB-B	6S PVC-638-6MTB-E

638 PVC HOSE BARB X FEMALE



PART #	BUNA (-B)	EPDM (-E)
6S PVC-638-4B4F	6S PVC-638-4B4F-B	6S PVC-638-4B4F-E
6S PVC-638-4B6F	6S PVC-638-4B6F-B	6S PVC-638-4B6F-E
6S PVC-638-4B8F	6S PVC-638-4B8F-B	6S PVC-638-4B8F-E
6S PVC-638-6B4F	6S PVC-638-6B4F-B	6S PVC-638-6B4F-E
6S PVC-638-6B6F	6S PVC-638-6B6F-B	6S PVC-638-6B6F-E
6S PVC-638-6B8F	6S PVC-638-6B8F-B	6S PVC-638-6B8F-E
6S PVC-638-8B4F	6S PVC-638-8B4F-B	6S PVC-638-8B4F-E
6S PVC-638-8B6F	6S PVC-638-8B6F-B	6S PVC-638-8B6F-E
6S PVC-638-8B8F	6S PVC-638-8B8F-B	6S PVC-638-8B8F-E

638 PVC HOSE BARB X MALE



PART #	BUNA (-B)	EPDM (-E)
6S PVC-638-4B2M	6S PVC-638-4B2M-B	6S PVC-638-4B2M-E
6S PVC-638-4B4M	6S PVC-638-4B4M-B	6S PVC-638-4B4M-E
6S PVC-638-4B6M	6S PVC-638-4B6M-B	6S PVC-638-4B6M-E
6S PVC-638-6B2M	6S PVC-638-6B2M-B	6S PVC-638-6B2M-E
6S PVC-638-6B4M	6S PVC-638-6B4M-B	6S PVC-638-6B4M-E
6S PVC-638-6B6M	6S PVC-638-6B6M-B	6S PVC-638-6B6M-E
6S PVC-638-8B2M	6S PVC-638-8B2M-B	6S PVC-638-8B2M-E
6S PVC-638-8B4M	6S PVC-638-8B4M-B	6S PVC-638-8B4M-E
6S PVC-638-8B6M	6S PVC-638-8B6M-B	6S PVC-638-8B6M-E

Specialty Valves: Plastic Ball Valves – Series 638

PRICING CODE

6S

638 PVC HOSE BARB X HOSE BARB



PART #	BUNA (-B)	EPDM (-E)
6S PVC-638-4B4B	6S PVC-638-4B4B-B	6S PVC-638-4B4B-E
6S PVC-638-4B6B	6S PVC-638-4B6B-B	6S PVC-638-4B6B-E
6S PVC-638-4B8B	6S PVC-638-4B8B-B	6S PVC-638-4B8B-E
6S PVC-638-6B4B	6S PVC-638-6B4B-B	6S PVC-638-6B4B-E
6S PVC-638-6B6B	6S PVC-638-6B6B-B	6S PVC-638-6B6B-E
6S PVC-638-6B8B	6S PVC-638-6B8B-B	6S PVC-638-6B8B-E
6S PVC-638-8B4B	6S PVC-638-8B4B-B	6S PVC-638-8B4B-E
6S PVC-638-8B6B	6S PVC-638-8B6B-B	6S PVC-638-8B6B-E
6S PVC-638-8B8B	6S PVC-638-8B8B-B	6S PVC-638-8B8B-E

638 PVC HOSE BARB X PUSH-CONNECT



PART #	BUNA (-B)	EPDM (-E)
6S PVC-638-4B4C	6S PVC-638-4B4C-B	6S PVC-638-4B4C-E
6S PVC-638-4B6C	6S PVC-638-4B6C-B	6S PVC-638-4B6C-E
6S PVC-638-6B4C	6S PVC-638-6B4C-B	6S PVC-638-6B4C-E
6S PVC-638-6B6C	6S PVC-638-6B6C-B	6S PVC-638-6B6C-E
6S PVC-638-8B4C	6S PVC-638-8B4C-B	6S PVC-638-8B4C-E
6S PVC-638-8B6C	6S PVC-638-8B6C-B	6S PVC-638-8B6C-E

638 PVC HOSE BARB X TAPERED BARB



PART #	BUNA (-B)	EPDM (-E)
6S PVC-638-4BTB	6S PVC-638-4BTB-B	6S PVC-638-4BTB-E
6S PVC-638-6BTB	6S PVC-638-6BTB-B	6S PVC-638-6BTB-E
6S PVC-638-8BTB	6S PVC-638-8BTB-B	6S PVC-638-8BTB-E

638 PVC PUSH-CONNECT X FEMALE



PART #	BUNA (-B)	EPDM (-E)
6S PVC-638-4C4F	6S PVC-638-4C4F-B	6S PVC-638-4C4F-E
6S PVC-638-4C6F	6S PVC-638-4C6F-B	6S PVC-638-4C6F-E
6S PVC-638-4C8F	6S PVC-638-4C8F-B	6S PVC-638-4C8F-E
6S PVC-638-6C4F	6S PVC-638-6C4F-B	6S PVC-638-6C4F-E
6S PVC-638-6C6F	6S PVC-638-6C6F-B	6S PVC-638-6C6F-E
6S PVC-638-6C8F	6S PVC-638-6C8F-B	6S PVC-638-6C8F-E

Specialty Valves: Plastic Ball Valves – Series 638

PRICING CODE

6S

638 PVC PUSH-CONNECT X MALE



PART #	BUNA (-B)	EPDM (-E)
6S PVC-638-4C2M	6S PVC-638-4C2M-B	6S PVC-638-4C2M-E
6S PVC-638-4C4M	6S PVC-638-4C4M-B	6S PVC-638-4C4M-E
6S PVC-638-4C6M	6S PVC-638-4C6M-B	6S PVC-638-4C6M-E
6S PVC-638-6C2M	6S PVC-638-6C2M-B	6S PVC-638-6C2M-E
6S PVC-638-6C4M	6S PVC-638-6C4M-B	6S PVC-638-6C4M-E
6S PVC-638-6C6M	6S PVC-638-6C6M-B	6S PVC-638-6C6M-E

638 PVC PUSH-CONNECT X HOSE BARB



PART #	BUNA (-B)	EPDM (-E)
6S PVC-638-4C4B	6S PVC-638-4C4B-B	6S PVC-638-4C4B-E
6S PVC-638-4C6B	6S PVC-638-4C6B-B	6S PVC-638-4C6B-E
6S PVC-638-4C8B	6S PVC-638-4C8B-B	6S PVC-638-4C8B-E
6S PVC-638-6C4B	6S PVC-638-6C4B-B	6S PVC-638-6C4B-E
6S PVC-638-6C6B	6S PVC-638-6C6B-B	6S PVC-638-6C6B-E
6S PVC-638-6C8B	6S PVC-638-6C8B-B	6S PVC-638-6C8B-E

638 PVC PUSH-CONNECT X PUSH-CONNECT



PART #	BUNA (-B)	EPDM (-E)
6S PVC-638-4C4C	6S PVC-638-4C4C-B	6S PVC-638-4C4C-E
6S PVC-638-4C6C	6S PVC-638-4C6C-B	6S PVC-638-4C6C-E
6S PVC-638-6C6C	6S PVC-638-6C6C-B	6S PVC-638-6C6C-E
6S PVC-638-6C4C	6S PVC-638-6C4C-B	6S PVC-638-6C4C-E

638 PVC PUSH-CONNECT X TAPERED BARB



PART #	BUNA (-B)	EPDM (-E)
6S PVC-638-4CTB	6S PVC-638-4CTB-B	6S PVC-638-4CTB-E
6S PVC-638-6CTB	6S PVC-638-6CTB-B	6S PVC-638-6CTB-E

Specialty Valves: Plastic Ball Valves – Series 638

PRICING CODE

6S

638 PVC TAPERED BARB X FEMALE



PART #	BUNA (-B)	EPDM (-E)
6S PVC-638-TB4F	6S PVC-638-TB4F-B	6S PVC-638-TB4F-E
6S PVC-638-TB6F	6S PVC-638-TB6F-B	6S PVC-638-TB6F-E
6S PVC-638-TB8F	6S PVC-638-TB8F-B	6S PVC-638-TB8F-E

638 PVC TAPERED BARB X MALE



PART #	BUNA (-B)	EPDM (-E)
6S PVC-638-TB2M	6S PVC-638-TB2M-B	6S PVC-638-TB2M-E
6S PVC-638-TB4M	6S PVC-638-TB4M-B	6S PVC-638-TB4M-E
6S PVC-638-TB6M	6S PVC-638-TB6M-B	6S PVC-638-TB6M-E

638 PVC TAPERED BARB X HOSE BARB



PART #	BUNA (-B)	EPDM (-E)
6S PVC-638-TB4B	6S PVC-638-TB4B-B	6S PVC-638-TB4B-E
6S PVC-638-TB6B	6S PVC-638-TB6B-B	6S PVC-638-TB6B-E
6S PVC-638-TB8B	6S PVC-638-TB8B-B	6S PVC-638-TB8B-E

638 PVC TAPERED BARB X PUSH-CONNECT



PART #	BUNA (-B)	EPDM (-E)
6S PVC-638-TB4C	6S PVC-638-TB4C-B	6S PVC-638-TB4C-E
6S PVC-638-TB6C	6S PVC-638-TB6C-B	6S PVC-638-TB6C-E

638 PVC TAPERED BARB X TAPERED BARB



PART #	BUNA (-B)	EPDM (-E)
6S PVC-638-TBTB	6S PVC-638-TBTB-B	6S PVC-638-TBTB-E

Specialty Valves: Plastic Ball Valves – Series 657

PRICING CODE

6S



NOTES:

- Materials: Body, ball, handle, ends - PVC
- Buna-N seals standard, ethylene propylene or fluoroelastomer seals available.
- For Technical Assistance, please call or fax our Customer Service Department.
- NSF LISTED COMPONENT

Calculate your part number using the key below. 6S should precede your part number. (SAMPLE: 6SPVC-638-4B4B-B)

PVC	638	4B	4B	B
MATERIAL OPTIONS	MODEL OPTIONS	INLET OPTIONS	OUTLET OPTIONS	SEAL TYPE OPTIONS
PVC - Gray PVC (Standard)	657	4F - 1/4" FPT	4F - 1/4" FPT	B - Buna
WPVC - White PVC*		6F - 3/8" FPT	6F - 3/8" FPT	E - EPDM
WFP - White Poly*		8F - 1/2" FPT	8F - 1/2" FPT	F - Vitor®*
BFP - Black Poly*		2M - 1/8" MPT	2M - 1/8" MPT	
		4M - 1/4" MPT	4M - 1/4" MPT	
		6M - 3/8" MPT	6M - 3/8" MPT	
		8M - 1/2" MPT	8M - 1/2" MPT	
		4B - 1/4" Hose Barb	4B - 1/4" Hose Barb	
		6B - 3/8" Hose Barb	6B - 3/8" Hose Barb	
		8B - 1/2" Hose Barb	8B - 1/2" Hose Barb	
		4C - 1/4" Push-Connect	4C - 1/4" Push-Connect	
		6C - 3/8" Push-Connect	6C - 3/8" Push-Connect	
		TB - 3/8" to 5/8" Tapered Barb	TB - 3/8" to 5/8" Tapered Barb	

*Call for pricing

657 PVC FEMALE X FEMALE



PART #	BUNA (-B)	EPDM (-E)
6S PVC-657-4F4F	6S PVC-657-4F4F-B	6S PVC-657-4F4F-E
6S PVC-657-4F6F	6S PVC-657-4F6F-B	6S PVC-657-4F6F-E
6S PVC-657-4F8F	6S PVC-657-4F8F-B	6S PVC-657-4F8F-E
6S PVC-657-6F4F	6S PVC-657-6F4F-B	6S PVC-657-6F4F-E
6S PVC-657-6F6F	6S PVC-657-6F6F-B	6S PVC-657-6F6F-E
6S PVC-657-6F8F	6S PVC-657-6F8F-B	6S PVC-657-6F8F-E
6S PVC-657-8F4F	6S PVC-657-8F4F-B	6S PVC-657-8F4F-E
6S PVC-657-8F6F	6S PVC-657-8F6F-B	6S PVC-657-8F6F-E
6S PVC-657-8F8F	6S PVC-657-8F8F-B	6S PVC-657-8F8F-E

Specialty Valves: Plastic Ball Valves – Series 657

PRICING CODE

6S

657 PVC FEMALE X MALE



PART #	BUNA (-B)	EPDM (-E)
6S PVC-657-4F4M	6S PVC-657-4F4M-B	6S PVC-657-4F4M-E
6S PVC-657-4F6M	6S PVC-657-4F6M-B	6S PVC-657-4F6M-E
6S PVC-657-4F8M	6S PVC-657-4F8M-B	6S PVC-657-4F8M-E
6S PVC-657-6F4M	6S PVC-657-6F4M-B	6S PVC-657-6F4M-E
6S PVC-657-6F6M	6S PVC-657-6F6M-B	6S PVC-657-6F6M-E
6S PVC-657-6F8M	6S PVC-657-6F8M-B	6S PVC-657-6F8M-E
6S PVC-657-8F4M	6S PVC-657-8F4M-B	6S PVC-657-8F4M-E
6S PVC-657-8F6M	6S PVC-657-8F6M-B	6S PVC-657-8F6M-E
6S PVC-657-8F8M	6S PVC-657-8F8M-B	6S PVC-657-8F8M-E

657 PVC FEMALE X HOSE BARB



PART #	BUNA (-B)	EPDM (-E)
6S PVC-657-4F4B	6S PVC-657-4F4B-B	6S PVC-657-4F4B-E
6S PVC-657-4F6B	6S PVC-657-4F6B-B	6S PVC-657-4F6B-E
6S PVC-657-4F8B	6S PVC-657-4F8B-B	6S PVC-657-4F8B-E
6S PVC-657-6F4B	6S PVC-657-6F4B-B	6S PVC-657-6F4B-E
6S PVC-657-6F6B	6S PVC-657-6F6B-B	6S PVC-657-6F6B-E
6S PVC-657-6F8B	6S PVC-657-6F8B-B	6S PVC-657-6F8B-E
6S PVC-657-8F4B	6S PVC-657-8F4B-B	6S PVC-657-8F4B-E
6S PVC-657-8F6B	6S PVC-657-8F6B-B	6S PVC-657-8F6B-E
6S PVC-657-8F8B	6S PVC-657-8F8B-B	6S PVC-657-8F8B-E

657 PVC FEMALE X PUSH-CONNECT



PART #	BUNA (-B)	EPDM (-E)
6S PVC-657-4F4C	6S PVC-657-4F4C-B	6S PVC-657-4F4C-E
6S PVC-657-4F6C	6S PVC-657-4F6C-B	6S PVC-657-4F6C-E
6S PVC-657-6F4C	6S PVC-657-6F4C-B	6S PVC-657-6F4C-E
6S PVC-657-6F6C	6S PVC-657-6F6C-B	6S PVC-657-6F6C-E
6S PVC-657-8F4C	6S PVC-657-8F4C-B	6S PVC-657-8F4C-E
6S PVC-657-8F6C	6S PVC-657-8F6C-B	6S PVC-657-8F6C-E

657 PVC FEMALE X TAPERED BARB



PART #	BUNA (-B)	EPDM (-E)
6S PVC-657-4FTB	6S PVC-657-4FTB-B	6S PVC-657-4FTB-E
6S PVC-657-6FTB	6S PVC-657-6FTB-B	6S PVC-657-6FTB-E
6S PVC-657-8FTB	6S PVC-657-8FTB-B	6S PVC-657-8FTB-E

Specialty Valves: Plastic Ball Valves – Series 657

PRICING CODE

6S

657 PVC MALE X FEMALE



PART #	BUNA (-B)	EPDM (-E)
6S PVC-657-2M4F	6S PVC-657-2M4F-B	6S PVC-657-2M4F-E
6S PVC-657-2M6F	6S PVC-657-2M6F-B	6S PVC-657-2M6F-E
6S PVC-657-2M8F	6S PVC-657-2M8F-B	6S PVC-657-2M8F-E
6S PVC-657-4M4F	6S PVC-657-4M4F-B	6S PVC-657-4M4F-E
6S PVC-657-4M6F	6S PVC-657-4M6F-B	6S PVC-657-4M6F-E
6S PVC-657-4M8F	6S PVC-657-4M8F-B	6S PVC-657-4M8F-E
6S PVC-657-6M4F	6S PVC-657-6M4F-B	6S PVC-657-6M4F-E
6S PVC-657-6M6F	6S PVC-657-6M6F-B	6S PVC-657-6M6F-E
6S PVC-657-6M8F	6S PVC-657-6M8F-B	6S PVC-657-6M8F-E

657 PVC MALE X MALE



PART #	BUNA (-B)	EPDM (-E)
6S PVC-657-2M2M	6S PVC-657-2M2M-B	6S PVC-657-2M2M-E
6S PVC-657-2M4M	6S PVC-657-2M4M-B	6S PVC-657-2M4M-E
6S PVC-657-2M6M	6S PVC-657-2M6M-B	6S PVC-657-2M6M-E
6S PVC-657-4M2M	6S PVC-657-4M2M-B	6S PVC-657-4M2M-E
6S PVC-657-4M4M	6S PVC-657-4M4M-B	6S PVC-657-4M4M-E
6S PVC-657-4M6M	6S PVC-657-4M6M-B	6S PVC-657-4M6M-E
6S PVC-657-6M2M	6S PVC-657-6M2M-B	6S PVC-657-6M2M-E
6S PVC-657-6M4M	6S PVC-657-6M4M-B	6S PVC-657-6M4M-E
6S PVC-657-6M6M	6S PVC-657-6M6M-B	6S PVC-657-6M6M-E

657 PVC MALE X HOSE BARB



PART #	BUNA (-B)	EPDM (-E)
6S PVC-657-2M4B	6S PVC-657-2M4B-B	6S PVC-657-2M4B-E
6S PVC-657-2M6B	6S PVC-657-2M6B-B	6S PVC-657-2M6B-E
6S PVC-657-2M8B	6S PVC-657-2M8B-B	6S PVC-657-2M8B-E
6S PVC-657-4M4B	6S PVC-657-4M4B-B	6S PVC-657-4M4B-E
6S PVC-657-4M6B	6S PVC-657-4M6B-B	6S PVC-657-4M6B-E
6S PVC-657-4M8B	6S PVC-657-4M8B-B	6S PVC-657-4M8B-E
6S PVC-657-6M4B	6S PVC-657-6M4B-B	6S PVC-657-6M4B-E
6S PVC-657-6M6B	6S PVC-657-6M6B-B	6S PVC-657-6M6B-E
6S PVC-657-6M8B	6S PVC-657-6M8B-B	6S PVC-657-6M8B-E

Specialty Valves: Plastic Ball Valves – Series 657

PRICING CODE

6S

657 PVC MALE X PUSH-CONNECT



PART #	BUNA (-B)	EPDM (-E)
6S PVC-657-2M4C	6S PVC-657-2M4C-B	6S PVC-657-2M4C-E
6S PVC-657-2M6C	6S PVC-657-2M6C-B	6S PVC-657-2M6C-E
6S PVC-657-4M4C	6S PVC-657-4M4C-B	6S PVC-657-4M4C-E
6S PVC-657-4M6C	6S PVC-657-4M6C-B	6S PVC-657-4M6C-E
6S PVC-657-6M4C	6S PVC-657-6M4C-B	6S PVC-657-6M4C-E
6S PVC-657-6M6C	6S PVC-657-6M6C-B	6S PVC-657-6M6C-E

657 PVC MALE X TAPERED BARB



PART #	BUNA (-B)	EPDM (-E)
6S PVC-657-2MTB	6S PVC-657-2MTB-B	6S PVC-657-2MTB-E
6S PVC-657-4MTB	6S PVC-657-4MTB-B	6S PVC-657-4MTB-E
6S PVC-657-6MTB	6S PVC-657-6MTB-B	6S PVC-657-6MTB-E

657 PVC HOSE BARB X FEMALE



PART #	BUNA (-B)	EPDM (-E)
6S PVC-657-4B4F	6S PVC-657-4B4F-B	6S PVC-657-4B4F-E
6S PVC-657-4B6F	6S PVC-657-4B6F-B	6S PVC-657-4B6F-E
6S PVC-657-4B8F	6S PVC-657-4B8F-B	6S PVC-657-4B8F-E
6S PVC-657-6B4F	6S PVC-657-6B4F-B	6S PVC-657-6B4F-E
6S PVC-657-6B6F	6S PVC-657-6B6F-B	6S PVC-657-6B6F-E
6S PVC-657-6B8F	6S PVC-657-6B8F-B	6S PVC-657-6B8F-E
6S PVC-657-8B4F	6S PVC-657-8B4F-B	6S PVC-657-8B4F-E
6S PVC-657-8B6F	6S PVC-657-8B6F-B	6S PVC-657-8B6F-E
6S PVC-657-8B8F	6S PVC-657-8B8F-B	6S PVC-657-8B8F-E

657 PVC HOSE BARB X MALE



PART #	BUNA (-B)	EPDM (-E)
6S PVC-657-4B2M	6S PVC-657-4B2M-B	6S PVC-657-4B2M-E
6S PVC-657-4B4M	6S PVC-657-4B4M-B	6S PVC-657-4B4M-E
6S PVC-657-4B6M	6S PVC-657-4B6M-B	6S PVC-657-4B6M-E
6S PVC-657-6B2M	6S PVC-657-6B2M-B	6S PVC-657-6B2M-E
6S PVC-657-6B4M	6S PVC-657-6B4M-B	6S PVC-657-6B4M-E
6S PVC-657-6B6M	6S PVC-657-6B6M-B	6S PVC-657-6B6M-E
6S PVC-657-8B2M	6S PVC-657-8B2M-B	6S PVC-657-8B2M-E
6S PVC-657-8B4M	6S PVC-657-8B4M-B	6S PVC-657-8B4M-E
6S PVC-657-8B6M	6S PVC-657-8B6M-B	6S PVC-657-8B6M-E

Specialty Valves: Plastic Ball Valves – Series 657

PRICING CODE | 6S

657 PVC HOSE BARB X HOSE BARB



PART #	BUNA (-B)	EPDM (-E)
6S PVC-657-4B4B	6S PVC-657-4B4B-B	6S PVC-657-4B4B-E
6S PVC-657-4B6B	6S PVC-657-4B6B-B	6S PVC-657-4B6B-E
6S PVC-657-4B8B	6S PVC-657-4B8B-B	6S PVC-657-4B8B-E
6S PVC-657-6B4B	6S PVC-657-6B4B-B	6S PVC-657-6B4B-E
6S PVC-657-6B6B	6S PVC-657-6B6B-B	6S PVC-657-6B6B-E
6S PVC-657-6B8B	6S PVC-657-6B8B-B	6S PVC-657-6B8B-E
6S PVC-657-8B4B	6S PVC-657-8B4B-B	6S PVC-657-8B4B-E
6S PVC-657-8B6B	6S PVC-657-8B6B-B	6S PVC-657-8B6B-E
6S PVC-657-8B8B	6S PVC-657-8B8B-B	6S PVC-657-8B8B-E

657 PVC HOSE BARB X PUSH-CONNECT



PART #	BUNA (-B)	EPDM (-E)
6S PVC-657-4B4C	6S PVC-657-4B4C-B	6S PVC-657-4B4C-E
6S PVC-657-4B6C	6S PVC-657-4B6C-B	6S PVC-657-4B6C-E
6S PVC-657-6B4C	6S PVC-657-6B4C-B	6S PVC-657-6B4C-E
6S PVC-657-6B6C	6S PVC-657-6B6C-B	6S PVC-657-6B6C-E
6S PVC-657-8B4C	6S PVC-657-8B4C-B	6S PVC-657-8B4C-E
6S PVC-657-8B6C	6S PVC-657-8B6C-B	6S PVC-657-8B6C-E

657 PVC HOSE BARB X TAPERED BARB



PART #	BUNA (-B)	EPDM (-E)
6S PVC-657-4BTB	6S PVC-657-4BTB-B	6S PVC-657-4BTB-E
6S PVC-657-6BTB	6S PVC-657-6BTB-B	6S PVC-657-6BTB-E
6S PVC-657-8BTB	6S PVC-657-8BTB-B	6S PVC-657-8BTB-E

657 PVC PUSH-CONNECT X FEMALE



PART #	BUNA (-B)	EPDM (-E)
6S PVC-657-4C4F	6S PVC-657-4C4F-B	6S PVC-657-4C4F-E
6S PVC-657-4C6F	6S PVC-657-4C6F-B	6S PVC-657-4C6F-E
6S PVC-657-4C8F	6S PVC-657-4C8F-B	6S PVC-657-4C8F-E
6S PVC-657-6C4F	6S PVC-657-6C4F-B	6S PVC-657-6C4F-E
6S PVC-657-6C6F	6S PVC-657-6C6F-B	6S PVC-657-6C6F-E
6S PVC-657-6C8F	6S PVC-657-6C8F-B	6S PVC-657-6C8F-E

Specialty Valves: Plastic Ball Valves – Series 657

PRICING CODE | 6S

657 PVC PUSH-CONNECT X MALE



PART #	BUNA (-B)	EPDM (-E)
6S PVC-657-4C2M	6S PVC-657-4C2M-B	6S PVC-657-4C2M-E
6S PVC-657-4C4M	6S PVC-657-4C4M-B	6S PVC-657-4C4M-E
6S PVC-657-4C6M	6S PVC-657-4C6M-B	6S PVC-657-4C6M-E
6S PVC-657-6C2M	6S PVC-657-6C2M-B	6S PVC-657-6C2M-E
6S PVC-657-6C4M	6S PVC-657-6C4M-B	6S PVC-657-6C4M-E
6S PVC-657-6C6M	6S PVC-657-6C6M-B	6S PVC-657-6C6M-E

657 PVC PUSH-CONNECT X HOSE BARB



PART #	BUNA (-B)	EPDM (-E)
6S PVC-657-4C4B	6S PVC-657-4C4B-B	6S PVC-657-4C4B-E
6S PVC-657-4C6B	6S PVC-657-4C6B-B	6S PVC-657-4C6B-E
6S PVC-657-4C8B	6S PVC-657-4C8B-B	6S PVC-657-4C8B-E
6S PVC-657-6C4B	6S PVC-657-6C4B-B	6S PVC-657-6C4B-E
6S PVC-657-6C6B	6S PVC-657-6C6B-B	6S PVC-657-6C6B-E
6S PVC-657-6C8B	6S PVC-657-6C8B-B	6S PVC-657-6C8B-E

657 PVC PUSH-CONNECT X PUSH-CONNECT



PART #	BUNA (-B)	EPDM (-E)
6S PVC-657-4C4C	6S PVC-657-4C4C-B	6S PVC-657-4C4C-E
6S PVC-657-6C6C	6S PVC-657-6C6C-B	6S PVC-657-6C6C-E

657 PVC PUSH-CONNECT X TAPERED BARB



PART #	BUNA (-B)	EPDM (-E)
6S PVC-657-4CTB	6S PVC-657-4CTB-B	6S PVC-657-4CTB-E
6S PVC-657-6CTB	6S PVC-657-6CTB-B	6S PVC-657-6CTB-E

657 PVC TAPERED BARB X FEMALE



PART #	BUNA (-B)	EPDM (-E)
6S PVC-657-TB4F	6S PVC-657-TB4F-B	6S PVC-657-TB4F-E
6S PVC-657-TB6F	6S PVC-657-TB6F-B	6S PVC-657-TB6F-E
6S PVC-657-TB8F	6S PVC-657-TB8F-B	6S PVC-657-TB8F-E

Specialty Valves: Plastic Ball Valves – Series 657

PRICING CODE | 6S

657 PVC TAPERED BARB X MALE



PART #	BUNA (-B)	EPDM (-E)
6S PVC-657-TB2M	6S PVC-657-TB2M-B	6S PVC-657-TB2M-E
6S PVC-657-TB4M	6S PVC-657-TB4M-B	6S PVC-657-TB4M-E
6S PVC-657-TB6M	6S PVC-657-TB6M-B	6S PVC-657-TB6M-E

657 PVC TAPERED BARB X HOSE BARB



PART #	BUNA (-B)	EPDM (-E)
6S PVC-657-TB4B	6S PVC-657-TB4B-B	6S PVC-657-TB4B-E
6S PVC-657-TB6B	6S PVC-657-TB6B-B	6S PVC-657-TB6B-E
6S PVC-657-TB8B	6S PVC-657-TB8B-B	6S PVC-657-TB8B-E

657 PVC TAPERED BARB X PUSH-CONNECT



PART #	BUNA (-B)	EPDM (-E)
6S PVC-657-TB4C	6S PVC-657-TB4C-B	6S PVC-657-TB4C-E
6S PVC-657-TB6C	6S PVC-657-TB6C-B	6S PVC-657-TB6C-E

657 PVC TAPERED BARB X TAPERED BARB



PART #	BUNA (-B)	EPDM (-E)
6S PVC-657-TBTB	6S PVC-657-TBTB-B	6S PVC-657-TBTB-E

Specialty Valves: Plastic Ball Valves – Series 226

PRICING CODE **6S**

FEATURES, APPLICATIONS AND/OR NOTES:

- Materials: Body, ball, handle, ends - PVC
- Buna-N seals standard, ethylene propylene or fluoroelastomer seals available.
- For Technical Assistance, please call or fax our Customer Service Department.

Calculate your part number using the key below. 6S should precede your part number. (SAMPLE: 6SPVC-226-4F4F-E)

PVC	226	4F	4F	E
MATERIAL OPTIONS	MODEL OPTIONS	INLET OPTIONS	OUTLET OPTIONS	SEAL TYPE OPTIONS
PVC - Gray PVC (Standard)	226	2F - 1/8" FPT	2F - 1/8" FPT	B - Buna
WPVC - White PVC*		4F - 1/4" FPT	4F - 1/4" FPT	E - EPDM
WFP - White Poly*		2M - 1/8" MPT	2M - 1/8" MPT	F - Viton®
WN - White Nylon*		4M - 1/4" MPT	4M - 1/4" MPT	
BN - Black Nylon*		2B - 1/8" Hose Barb	2B - 1/8" Hose Barb	
PVDF - Black PVDF*		4B - 1/4" Hose Barb	4B - 1/4" Hose Barb	
		5B - 5/16" (8mm) Hose Barb	5B - 5/16" (8mm) Hose Barb	
		6B - 3/8" Hose Barb	6B - 3/8" Hose Barb	
		8B - 1/2" Hose Barb	8B - 1/2" Hose Barb	
		4C - 1/4" Push-Connect	4C - 1/4" Push-Connect	
		6C - 3/8" Push-Connect	6C - 3/8" Push-Connect	
		6BIB - 3/8" Smooth Barb *	6BIB - 3/8" Smooth Barb *	

*Call for pricing

226 PVC FEMALE X FEMALE



PART #	BUNA (-B)	EPDM (-E)	VITON® (-F)
6S PVC-226-2F2F	6S PVC-226-2F2F-B	6S PVC-226-2F2F-E	6S PVC-226-2F2F-F
6S PVC-226-2F4F	6S PVC-226-2F4F-B	6S PVC-226-2F4F-E	6S PVC-226-2F4F-F
6S PVC-226-4F2F	6S PVC-226-4F2F-B	6S PVC-226-4F2F-E	6S PVC-226-4F2F-F
6S PVC-226-4F4F	6S PVC-226-4F4F-B	6S PVC-226-4F4F-E	6S PVC-226-4F4F-F

226 PVC FEMALE X MALE



PART #	BUNA (-B)	EPDM (-E)	VITON® (-F)
6S PVC-226-2F2M	6S PVC-226-2F2M-B	6S PVC-226-2F2M-E	6S PVC-226-2F2M-F
6S PVC-226-2F4M	6S PVC-226-2F4M-B	6S PVC-226-2F4M-E	6S PVC-226-2F4M-F
6S PVC-226-4F2M	6S PVC-226-4F2M-B	6S PVC-226-4F2M-E	6S PVC-226-4F2M-F
6S PVC-226-4F4M	6S PVC-226-4F4M-B	6S PVC-226-4F4M-E	6S PVC-226-4F4M-F

Specialty Valves: Plastic Ball Valves – Series 226

PRICING CODE

6S

226 PVC FEMALE X HOSE BARB

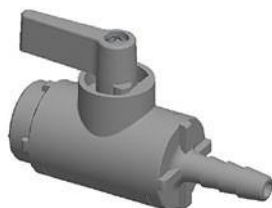

PART #	BUNA (-B)	EPDM (-E)	VITON® (-F)
6S PVC-226-2F2B	6S PVC-226-2F2B-B	6S PVC-226-2F2B-E	6S PVC-226-2F2B-F
6S PVC-226-2F4B	6S PVC-226-2F4B-B	6S PVC-226-2F4B-E	6S PVC-226-2F4B-F
6S PVC-226-2F5B	6S PVC-226-2F5B-B	6S PVC-226-2F5B-E	6S PVC-226-2F5B-F
6S PVC-226-2F6B	6S PVC-226-2F6B-B	6S PVC-226-2F6B-E	6S PVC-226-2F6B-F
6S PVC-226-2F8B	6S PVC-226-2F8B-B	6S PVC-226-2F8B-E	6S PVC-226-2F8B-F
6S PVC-226-4F2B	6S PVC-226-4F2B-B	6S PVC-226-4F2B-E	6S PVC-226-4F2B-F
6S PVC-226-4F4B	6S PVC-226-4F4B-B	6S PVC-226-4F4B-E	6S PVC-226-4F4B-F
6S PVC-226-4F5B	6S PVC-226-4F5B-B	6S PVC-226-4F5B-E	6S PVC-226-4F5B-F
6S PVC-226-4F6B	6S PVC-226-4F6B-B	6S PVC-226-4F6B-E	6S PVC-226-4F6B-F
6S PVC-226-4F8B	6S PVC-226-4F8B-B	6S PVC-226-4F8B-E	6S PVC-226-4F8B-F

226 PVC FEMALE X PUSH-CONNECT



PART #	BUNA (-B)	EPDM (-E)	VITON® (-F)
6S PVC-226-2F4C	6S PVC-226-2F4C-B	6S PVC-226-2F4C-E	6S PVC-226-2F4C-F
6S PVC-226-2F6C	6S PVC-226-2F6C-B	6S PVC-226-2F6C-E	6S PVC-226-2F6C-F
6S PVC-226-4F4C	6S PVC-226-4F4C-B	6S PVC-226-4F4C-E	6S PVC-226-4F4C-F
6S PVC-226-4F6C	6S PVC-226-4F6C-B	6S PVC-226-4F6C-E	6S PVC-226-4F6C-F

226 PVC MALE X FEMALE



PART #	BUNA (-B)	EPDM (-E)	VITON® (-F)
6S PVC-226-2M2F	6S PVC-226-2M2F-B	6S PVC-226-2M2F-E	6S PVC-226-2M2F-F
6S PVC-226-2M4F	6S PVC-226-2M4F-B	6S PVC-226-2M4F-E	6S PVC-226-2M4F-F
6S PVC-226-4M2F	6S PVC-226-4M2F-B	6S PVC-226-4M2F-E	6S PVC-226-4M2F-F
6S PVC-226-4M4F	6S PVC-226-4M4F-B	6S PVC-226-4M4F-E	6S PVC-226-4M4F-F

226 PVC MALE X MALE



PART #	BUNA (-B)	EPDM (-E)	VITON® (-F)
6S PVC-226-2M2M	6S PVC-226-2M2M-B	6S PVC-226-2M2M-E	6S PVC-226-2M2M-F
6S PVC-226-2M4M	6S PVC-226-2M4M-B	6S PVC-226-2M4M-E	6S PVC-226-2M4M-F
6S PVC-226-4M2M	6S PVC-226-4M2M-B	6S PVC-226-4M2M-E	6S PVC-226-4M2M-F
6S PVC-226-4M4M	6S PVC-226-4M4M-B	6S PVC-226-4M4M-E	6S PVC-226-4M4M-F

Specialty Valves: Plastic Ball Valves – Series 226

PRICING CODE **6S**

226 PVC MALE X HOSE BARB



PART #	BUNA (-B)	EPDM (-E)	VITON® (-F)
6S PVC-226-2M2B	6S PVC-226-2M2B-B	6S PVC-226-2M2B-E	6S PVC-226-2M2B-F
6S PVC-226-2M4B	6S PVC-226-2M4B-B	6S PVC-226-2M4B-E	6S PVC-226-2M4B-F
6S PVC-226-2M5B	6S PVC-226-2M5B-B	6S PVC-226-2M5B-E	6S PVC-226-2M5B-F
6S PVC-226-2M6B	6S PVC-226-2M6B-B	6S PVC-226-2M6B-E	6S PVC-226-2M6B-F
6S PVC-226-2M8B	6S PVC-226-2M8B-B	6S PVC-226-2M8B-E	6S PVC-226-2M8B-F
6S PVC-226-4M2B	6S PVC-226-4M2B-B	6S PVC-226-4M2B-E	6S PVC-226-4M2B-F
6S PVC-226-4M4B	6S PVC-226-4M4B-B	6S PVC-226-4M4B-E	6S PVC-226-4M4B-F
6S PVC-226-4M5B	6S PVC-226-4M5B-B	6S PVC-226-4M5B-E	6S PVC-226-4M5B-F
6S PVC-226-4M6B	6S PVC-226-4M6B-B	6S PVC-226-4M6B-E	6S PVC-226-4M6B-F
6S PVC-226-4M8B	6S PVC-226-4M8B-B	6S PVC-226-4M8B-E	6S PVC-226-4M8B-F

226 PVC MALE X PUSH-CONNECT



PART #	BUNA (-B)	EPDM (-E)	VITON® (-F)
6S PVC-226-2M4C	6S PVC-226-2M4C-B	6S PVC-226-2M4C-E	6S PVC-226-2M4C-F
6S PVC-226-2M6C	6S PVC-226-2M6C-B	6S PVC-226-2M6C-E	6S PVC-226-2M6C-F
6S PVC-226-4M4C	6S PVC-226-4M4C-B	6S PVC-226-4M4C-E	6S PVC-226-4M4C-F
6S PVC-226-4M6C	6S PVC-226-4M6C-B	6S PVC-226-4M6C-E	6S PVC-226-4M6C-F

226 PVC HOSE BARB X FEMALE



PART #	BUNA (-B)	EPDM (-E)	VITON® (-F)
6S PVC-226-2B2F	6S PVC-226-2B2F-B	6S PVC-226-2B2F-E	6S PVC-226-2B2F-F
6S PVC-226-2B4F	6S PVC-226-2B4F-B	6S PVC-226-2B4F-E	6S PVC-226-2B4F-F
6S PVC-226-4B2F	6S PVC-226-4B2F-B	6S PVC-226-4B2F-E	6S PVC-226-4B2F-F
6S PVC-226-4B4F	6S PVC-226-4B4F-B	6S PVC-226-4B4F-E	6S PVC-226-4B4F-F
6S PVC-226-5B2F	6S PVC-226-5B2F-B	6S PVC-226-5B2F-E	6S PVC-226-5B2F-F
6S PVC-226-5B4F	6S PVC-226-5B4F-B	6S PVC-226-5B4F-E	6S PVC-226-5B4F-F
6S PVC-226-6B2F	6S PVC-226-6B2F-B	6S PVC-226-6B2F-E	6S PVC-226-6B2F-F
6S PVC-226-6B4F	6S PVC-226-6B4F-B	6S PVC-226-6B4F-E	6S PVC-226-6B4F-F
6S PVC-226-8B2F	6S PVC-226-8B2F-B	6S PVC-226-8B2F-E	6S PVC-226-8B2F-F
6S PVC-226-8B4F	6S PVC-226-8B4F-B	6S PVC-226-8B4F-E	6S PVC-226-8B4F-F

226 PVC HOSE BARB X MALE



PART #	BUNA (-B)	EPDM (-E)	VITON® (-F)
6S PVC-226-2B2M	6S PVC-226-2B2M-B	6S PVC-226-2B2M-E	6S PVC-226-2B2M-F
6S PVC-226-2B4M	6S PVC-226-2B4M-B	6S PVC-226-2B4M-E	6S PVC-226-2B4M-F
6S PVC-226-4B2M	6S PVC-226-4B2M-B	6S PVC-226-4B2M-E	6S PVC-226-4B2M-F
6S PVC-226-4B4M	6S PVC-226-4B4M-B	6S PVC-226-4B4M-E	6S PVC-226-4B4M-F
6S PVC-226-5B2M	6S PVC-226-5B2M-B	6S PVC-226-5B2M-E	6S PVC-226-5B2M-F
6S PVC-226-5B4M	6S PVC-226-5B4M-B	6S PVC-226-5B4M-E	6S PVC-226-5B4M-F
6S PVC-226-6B2M	6S PVC-226-6B2M-B	6S PVC-226-6B2M-E	6S PVC-226-6B2M-F
6S PVC-226-6B4M	6S PVC-226-6B4M-B	6S PVC-226-6B4M-E	6S PVC-226-6B4M-F
6S PVC-226-8B2M	6S PVC-226-8B2M-B	6S PVC-226-8B2M-E	6S PVC-226-8B2M-F
6S PVC-226-8B4M	6S PVC-226-8B4M-B	6S PVC-226-8B4M-E	6S PVC-226-8B4M-F

Specialty Valves: Plastic Ball Valves – Series 226

PRICING CODE

6S

226 PVC HOSE BARB X HOSE BARB



PART #	BUNA (-B)	EPDM (-E)	VITON® (-F)
6S PVC-226-2B2B	6S PVC-226-2B2B-B	6S PVC-226-2B2B-E	6S PVC-226-2B2B-F
6S PVC-226-2B4B	6S PVC-226-2B4B-B	6S PVC-226-2B4B-E	6S PVC-226-2B4B-F
6S PVC-226-2B5B	6S PVC-226-2B5B-B	6S PVC-226-2B5B-E	6S PVC-226-2B5B-F
6S PVC-226-2B6B	6S PVC-226-2B6B-B	6S PVC-226-2B6B-E	6S PVC-226-2B6B-F
6S PVC-226-2B8B	6S PVC-226-2B8B-B	6S PVC-226-2B8B-E	6S PVC-226-2B8B-F
6S PVC-226-4B2B	6S PVC-226-4B2B-B	6S PVC-226-4B2B-E	6S PVC-226-4B2B-F
6S PVC-226-4B4B	6S PVC-226-4B4B-B	6S PVC-226-4B4B-E	6S PVC-226-4B4B-F
6S PVC-226-4B5B	6S PVC-226-4B5B-B	6S PVC-226-4B5B-E	6S PVC-226-4B5B-F
6S PVC-226-4B6B	6S PVC-226-4B6B-B	6S PVC-226-4B6B-E	6S PVC-226-4B6B-F
6S PVC-226-4B8B	6S PVC-226-4B8B-B	6S PVC-226-4B8B-E	6S PVC-226-4B8B-F
6S PVC-226-5B2B	6S PVC-226-5B2B-B	6S PVC-226-5B2B-E	6S PVC-226-5B2B-F
6S PVC-226-5B4B	6S PVC-226-5B4B-B	6S PVC-226-5B4B-E	6S PVC-226-5B4B-F
6S PVC-226-5B5B	6S PVC-226-5B5B-B	6S PVC-226-5B5B-E	6S PVC-226-5B5B-F
6S PVC-226-5B6B	6S PVC-226-5B6B-B	6S PVC-226-5B6B-E	6S PVC-226-5B6B-F
6S PVC-226-5B8B	6S PVC-226-5B8B-B	6S PVC-226-5B8B-E	6S PVC-226-5B8B-F
6S PVC-226-6B2B	6S PVC-226-6B2B-B	6S PVC-226-6B2B-E	6S PVC-226-6B2B-F
6S PVC-226-6B4B	6S PVC-226-6B4B-B	6S PVC-226-6B4B-E	6S PVC-226-6B4B-F
6S PVC-226-6B5B	6S PVC-226-6B5B-B	6S PVC-226-6B5B-E	6S PVC-226-6B5B-F
6S PVC-226-6B6B	6S PVC-226-6B6B-B	6S PVC-226-6B6B-E	6S PVC-226-6B6B-F
6S PVC-226-6B8B	6S PVC-226-6B8B-B	6S PVC-226-6B8B-E	6S PVC-226-6B8B-F
6S PVC-226-8B2B	6S PVC-226-8B2B-B	6S PVC-226-8B2B-E	6S PVC-226-8B2B-F
6S PVC-226-8B4B	6S PVC-226-8B4B-B	6S PVC-226-8B4B-E	6S PVC-226-8B4B-F
6S PVC-226-8B5B	6S PVC-226-8B5B-B	6S PVC-226-8B5B-E	6S PVC-226-8B5B-F
6S PVC-226-8B6B	6S PVC-226-8B6B-B	6S PVC-226-8B6B-E	6S PVC-226-8B6B-F
6S PVC-226-8B8B	6S PVC-226-8B8B-B	6S PVC-226-8B8B-E	6S PVC-226-8B8B-F

226 PVC HOSE BARB X PUSH-CONNECT



PART #	BUNA (-B)	EPDM (-E)	VITON® (-F)
6S PVC-226-2B4C	6S PVC-226-2B4C-B	6S PVC-226-2B4C-E	6S PVC-226-2B4C-F
6S PVC-226-2B6C	6S PVC-226-2B6C-B	6S PVC-226-2B6C-E	6S PVC-226-2B6C-F
6S PVC-226-4B4C	6S PVC-226-4B4C-B	6S PVC-226-4B4C-E	6S PVC-226-4B4C-F
6S PVC-226-4B6C	6S PVC-226-4B6C-B	6S PVC-226-4B6C-E	6S PVC-226-4B6C-F
6S PVC-226-5B4C	6S PVC-226-5B4C-B	6S PVC-226-5B4C-E	6S PVC-226-5B4C-F
6S PVC-226-5B6C	6S PVC-226-5B6C-B	6S PVC-226-5B6C-E	6S PVC-226-5B6C-F
6S PVC-226-6B4C	6S PVC-226-6B4C-B	6S PVC-226-6B4C-E	6S PVC-226-6B4C-F
6S PVC-226-6B6C	6S PVC-226-6B6C-B	6S PVC-226-6B6C-E	6S PVC-226-6B6C-F
6S PVC-226-8B4C	6S PVC-226-8B4C-B	6S PVC-226-8B4C-E	6S PVC-226-8B4C-F
6S PVC-226-8B6C	6S PVC-226-8B6C-B	6S PVC-226-8B6C-E	6S PVC-226-8B6C-F

Specialty Valves: Plastic Ball Valves – Series 226

PRICING CODE

6S

226 PVC PUSH-CONNECT X FEMALE



PART #	BUNA (-B)	EPDM (-E)	VITON® (-F)
6S PVC-226-4C2F	6S PVC-226-4C2F-B	6S PVC-226-4C2F-E	6S PVC-226-4C2F-F
6S PVC-226-4C4F	6S PVC-226-4C4F-B	6S PVC-226-4C4F-E	6S PVC-226-4C4F-F

226 PVC PUSH-CONNECT X MALE



PART #	BUNA (-B)	EPDM (-E)	VITON® (-F)
6S PVC-226-4C2M	6S PVC-226-4C2M-B	6S PVC-226-4C2M-E	6S PVC-226-4C2M-F
6S PVC-226-4C4M	6S PVC-226-4C4M-B	6S PVC-226-4C4M-E	6S PVC-226-4C4M-F

226 PVC PUSH-CONNECT X HOSE BARB



PART #	BUNA (-B)	EPDM (-E)	VITON® (-F)
6S PVC-226-4C2B	6S PVC-226-4C2B-B	6S PVC-226-4C2B-E	6S PVC-226-4C2B-F
6S PVC-226-4C4B	6S PVC-226-4C4B-B	6S PVC-226-4C4B-E	6S PVC-226-4C4B-F
6S PVC-226-4C5B	6S PVC-226-4C5B-B	6S PVC-226-4C5B-E	6S PVC-226-4C5B-F
6S PVC-226-4C6B	6S PVC-226-4C6B-B	6S PVC-226-4C6B-E	6S PVC-226-4C6B-F
6S PVC-226-4C8B	6S PVC-226-4C8B-B	6S PVC-226-4C8B-E	6S PVC-226-4C8B-F

226 PVC PUSH-CONNECT X PUSH-CONNECT



PART #	BUNA (-B)	EPDM (-E)	VITON® (-F)
6S PVC-226-4C4C	6S PVC-226-4C4C-B	6S PVC-226-4C4C-E	6S PVC-226-4C4C-F
6S PVC-226-4C6C	6S PVC-226-4C6C-B	6S PVC-226-4C6C-E	6S PVC-226-4C6C-F

Specialty Valves: Plastic Check Valves – Series 426

PRICING CODE

6S



FEATURES, APPLICATIONS AND/OR NOTES:

- The 426 series PVC valve operates in any position, horizontal or vertical, and is available in mix or matched end combination.
- Standard cracking pressure 1 psi (optional 1/3, 3 or 7 psi available) with a maximum operating pressure of 125 psi and a maximum operating temperature of 140° F.
- Buna seals standard, ethylene propylene or fluoroelastomer seals available.
- Guided stainless steel or teflon ball with O-Quad ring seat. Available with hastelloy springs.
- For technical assistance, custom springs, and end combinations, please call.
- NSF LISTED COMPONENT

Calculate your part number using the key below. 6S should precede your part number. (SAMPLE: 6SPVC-426-4F4F-E1/3)

PVC	-	426	-	4F	-	4F	-	E	-	1/3
MATERIAL OPTIONS		MODEL OPTIONS		INLET OPTIONS		OUTLET OPTIONS		SEAL TYPE OPTIONS		CRACKING PRESSURE OPTIONS
PVC - Gray PVC (Standard)		426		2F - 1/8" FPT		2F - 1/8" FPT		B - Buna		1/3 PSI
WPVC - White PVC*				4F - 1/4" FPT		4F - 1/4" FPT		E - EPDM		1 PSI (Standard)
WFP - White Poly*				2M - 1/8" MPT		2M - 1/8" MPT		F - Viton®		1.5 PSI
WN - White Nylon*				4M - 1/4" MPT		4M - 1/4" MPT				3 PSI
BN - Black Nylon*				2B - 1/8" Hose Barb		2B - 1/8" Hose Barb				5 PSI
PVDF - Black PVDF*				4B - 1/4" Hose Barb		4B - 1/4" Hose Barb				7 PSI
				5B - 5/16" (8mm) Hose Barb		5B - 5/16" (8mm) Hose Barb				10 PSI
				6B - 3/8" Hose Barb		6B - 3/8" Hose Barb				12 PSI
				8B - 1/2" Hose Barb		8B - 1/2" Hose Barb				
				4C - 1/4" Push-Connect		4C - 1/4" Push-Connect				
				6C - 3/8" Push-Connect		6C - 3/8" Push-Connect				
				6BIB - 3/8" Smooth Barb		6BIB - 3/8" Smooth Barb				

*Call for pricing

426 PVC FEMALE X FEMALE



PART #	BUNA (-B)	EPDM (-E)	VITON® (-F)
6S PVC-426-2F2F	6S PVC-426-2F2F-B	6S PVC-426-2F2F-E	6S PVC-426-2F2F-F
6S PVC-426-2F4F	6S PVC-426-2F4F-B	6S PVC-426-2F4F-E	6S PVC-426-2F4F-F
6S PVC-426-4F2F	6S PVC-426-4F2F-B	6S PVC-426-4F2F-E	6S PVC-426-4F2F-F
6S PVC-426-4F4F	6S PVC-426-4F4F-B	6S PVC-426-4F4F-E	6S PVC-426-4F4F-F

426 PVC FEMALE X MALE



PART #	BUNA (-B)	EPDM (-E)	VITON® (-F)
6S PVC-426-2F2M	6S PVC-426-2F2M-B	6S PVC-426-2F2M-E	6S PVC-426-2F2M-F
6S PVC-426-2F4M	6S PVC-426-2F4M-B	6S PVC-426-2F4M-E	6S PVC-426-2F4M-F
6S PVC-426-4F2M	6S PVC-426-4F2M-B	6S PVC-426-4F2M-E	6S PVC-426-4F2M-F
6S PVC-426-4F4M	6S PVC-426-4F4M-B	6S PVC-426-4F4M-E	6S PVC-426-4F4M-F

Specialty Valves: Plastic Check Valves – Series 426

PRICING CODE

6S

426 PVC FEMALE X HOSE BARB



PART #	BUNA (-B)	EPDM (-E)	VITON® (-F)
6S PVC-426-2F2B	6S PVC-426-2F2B-B	6S PVC-426-2F2B-E	6S PVC-426-2F2B-F
6S PVC-426-2F4B	6S PVC-426-2F4B-B	6S PVC-426-2F4B-E	6S PVC-426-2F4B-F
6S PVC-426-2F5B	6S PVC-426-2F5B-B	6S PVC-426-2F5B-E	6S PVC-426-2F5B-F
6S PVC-426-2F6B	6S PVC-426-2F6B-B	6S PVC-426-2F6B-E	6S PVC-426-2F6B-F
6S PVC-426-2F8B	6S PVC-426-2F8B-B	6S PVC-426-2F8B-E	6S PVC-426-2F8B-F
6S PVC-426-4F2B	6S PVC-426-4F2B-B	6S PVC-426-4F2B-E	6S PVC-426-4F2B-F
6S PVC-426-4F4B	6S PVC-426-4F4B-B	6S PVC-426-4F4B-E	6S PVC-426-4F4B-F
6S PVC-426-4F5B	6S PVC-426-4F5B-B	6S PVC-426-4F5B-E	6S PVC-426-4F5B-F
6S PVC-426-4F6B	6S PVC-426-4F6B-B	6S PVC-426-4F6B-E	6S PVC-426-4F6B-F
6S PVC-426-4F8B	6S PVC-426-4F8B-B	6S PVC-426-4F8B-E	6S PVC-426-4F8B-F

426 PVC FEMALE X PUSH-CONNECT



PART #	BUNA (-B)	EPDM (-E)	VITON® (-F)
6S PVC-426-2F4C	6S PVC-426-2F4C-B	6S PVC-426-2F4C-E	6S PVC-426-2F4C-F
6S PVC-426-2F6C	6S PVC-426-2F6C-B	6S PVC-426-2F6C-E	6S PVC-426-2F6C-F
6S PVC-426-4F4C	6S PVC-426-4F4C-B	6S PVC-426-4F4C-E	6S PVC-426-4F4C-F
6S PVC-426-4F6C	6S PVC-426-4F6C-B	6S PVC-426-4F6C-E	6S PVC-426-4F6C-F

426 PVC FEMALE X SMOOTH BARB



PART #	BUNA (-B)	EPDM (-E)	VITON® (-F)
6S PVC-426-2F6BIB	6S PVC-426-2F6BIB-B	6S PVC-426-2F6BIB-E	6S PVC-426-2F6BIB-F
6S PVC-426-4F6BIB	6S PVC-426-4F6BIB-B	6S PVC-426-4F6BIB-E	6S PVC-426-4F6BIB-F

426 PVC MALE X FEMALE



PART #	BUNA (-B)	EPDM (-E)	VITON® (-F)
6S PVC-426-2M2F	6S PVC-426-2M2F-B	6S PVC-426-2M2F-E	6S PVC-426-2M2F-F
6S PVC-426-2M4F	6S PVC-426-2M4F-B	6S PVC-426-2M4F-E	6S PVC-426-2M4F-F
6S PVC-426-4M2F	6S PVC-426-4M2F-B	6S PVC-426-4M2F-E	6S PVC-426-4M2F-F
6S PVC-426-4M4F	6S PVC-426-4M4F-B	6S PVC-426-4M4F-E	6S PVC-426-4M4F-F

Specialty Valves: Plastic Check Valves – Series 426

PRICING CODE

6S

426 PVC MALE X MALE



PART #	BUNA (-B)	EPDM (-E)	VITON® (-F)
6S PVC-426-2M2M	6S PVC-426-2M2M-B	6S PVC-426-2M2M-E	6S PVC-426-2M2M-F
6S PVC-426-2M4M	6S PVC-426-2M4M-B	6S PVC-426-2M4M-E	6S PVC-426-2M4M-F
6S PVC-426-4M2M	6S PVC-426-4M2M-B	6S PVC-426-4M2M-E	6S PVC-426-4M2M-F
6S PVC-426-4M4M	6S PVC-426-4M4M-B	6S PVC-426-4M4M-E	6S PVC-426-4M4M-F

426 PVC MALE X HOSE BARB



PART #	BUNA (-B)	EPDM (-E)	VITON® (-F)
6S PVC-426-2M2B	6S PVC-426-2M2B-B	6S PVC-426-2M2B-E	6S PVC-426-2M2B-F
6S PVC-426-2M4B	6S PVC-426-2M4B-B	6S PVC-426-2M4B-E	6S PVC-426-2M4B-F
6S PVC-426-2M5B	6S PVC-426-2M5B-B	6S PVC-426-2M5B-E	6S PVC-426-2M5B-F
6S PVC-426-2M6B	6S PVC-426-2M6B-B	6S PVC-426-2M6B-E	6S PVC-426-2M6B-F
6S PVC-426-2M8B	6S PVC-426-2M8B-B	6S PVC-426-2M8B-E	6S PVC-426-2M8B-F
6S PVC-426-4M2B	6S PVC-426-4M2B-B	6S PVC-426-4M2B-E	6S PVC-426-4M2B-F
6S PVC-426-4M4B	6S PVC-426-4M4B-B	6S PVC-426-4M4B-E	6S PVC-426-4M4B-F
6S PVC-426-4M5B	6S PVC-426-4M5B-B	6S PVC-426-4M5B-E	6S PVC-426-4M5B-F
6S PVC-426-4M6B	6S PVC-426-4M6B-B	6S PVC-426-4M6B-E	6S PVC-426-4M6B-F
6S PVC-426-4M8B	6S PVC-426-4M8B-B	6S PVC-426-4M8B-E	6S PVC-426-4M8B-F

426 PVC MALE X PUSH-CONNECT



PART #	BUNA (-B)	EPDM (-E)	VITON® (-F)
6S PVC-426-2M4C	6S PVC-426-2M4C-B	6S PVC-426-2M4C-E	6S PVC-426-2M4C-F
6S PVC-426-2M6C	6S PVC-426-2M6C-B	6S PVC-426-2M6C-E	6S PVC-426-2M6C-F
6S PVC-426-4M4C	6S PVC-426-4M4C-B	6S PVC-426-4M4C-E	6S PVC-426-4M4C-F
6S PVC-426-4M6C	6S PVC-426-4M6C-B	6S PVC-426-4M6C-E	6S PVC-426-4M6C-F

426 PVC MALE X SMOOTH BARB



PART #	BUNA (-B)	EPDM (-E)	VITON® (-F)
6S PVC-426-2M6BIB	6S PVC-426-2M6BIB-B	6S PVC-426-2M6BIB-E	6S PVC-426-2M6BIB-F
6S PVC-426-4M6BIB	6S PVC-426-4M6BIB-B	6S PVC-426-4M6BIB-E	6S PVC-426-4M6BIB-F

Specialty Valves: Plastic Check Valves – Series 426

PRICING CODE

6S

426 PVC HOSE BARB X FEMALE



PART #	BUNA (-B)	EPDM (-E)	VITON® (-F)
6S PVC-426-2B2F	6S PVC-426-2B2F-B	6S PVC-426-2B2F-E	6S PVC-426-2B2F-F
6S PVC-426-2B4F	6S PVC-426-2B4F-B	6S PVC-426-2B4F-E	6S PVC-426-2B4F-F
6S PVC-426-4B2F	6S PVC-426-4B2F-B	6S PVC-426-4B2F-E	6S PVC-426-4B2F-F
6S PVC-426-4B4F	6S PVC-426-4B4F-B	6S PVC-426-4B4F-E	6S PVC-426-4B4F-F
6S PVC-426-5B2F	6S PVC-426-5B2F-B	6S PVC-426-5B2F-E	6S PVC-426-5B2F-F
6S PVC-426-5B4F	6S PVC-426-5B4F-B	6S PVC-426-5B4F-E	6S PVC-426-5B4F-F
6S PVC-426-6B2F	6S PVC-426-6B2F-B	6S PVC-426-6B2F-E	6S PVC-426-6B2F-F
6S PVC-426-6B4F	6S PVC-426-6B4F-B	6S PVC-426-6B4F-E	6S PVC-426-6B4F-F
6S PVC-426-8B2F	6S PVC-426-8B2F-B	6S PVC-426-8B2F-E	6S PVC-426-8B2F-F
6S PVC-426-8B4F	6S PVC-426-8B4F-B	6S PVC-426-8B4F-E	6S PVC-426-8B4F-F

426 PVC HOSE BARB X MALE



PART #	BUNA (-B)	EPDM (-E)	VITON® (-F)
6S PVC-426-2B2M	6S PVC-426-2B2M-B	6S PVC-426-2B2M-E	6S PVC-426-2B2M-F
6S PVC-426-2B4M	6S PVC-426-2B4M-B	6S PVC-426-2B4M-E	6S PVC-426-2B4M-F
6S PVC-426-4B2M	6S PVC-426-4B2M-B	6S PVC-426-4B2M-E	6S PVC-426-4B2M-F
6S PVC-426-4B4M	6S PVC-426-4B4M-B	6S PVC-426-4B4M-E	6S PVC-426-4B4M-F
6S PVC-426-5B2M	6S PVC-426-5B2M-B	6S PVC-426-5B2M-E	6S PVC-426-5B2M-F
6S PVC-426-5B4M	6S PVC-426-5B4M-B	6S PVC-426-5B4M-E	6S PVC-426-5B4M-F
6S PVC-426-6B2M	6S PVC-426-6B2M-B	6S PVC-426-6B2M-E	6S PVC-426-6B2M-F
6S PVC-426-6B4M	6S PVC-426-6B4M-B	6S PVC-426-6B4M-E	6S PVC-426-6B4M-F
6S PVC-426-8B2M	6S PVC-426-8B2M-B	6S PVC-426-8B2M-E	6S PVC-426-8B2M-F
6S PVC-426-8B4M	6S PVC-426-8B4M-B	6S PVC-426-8B4M-E	6S PVC-426-8B4M-F

426 PVC HOSE BARB X HOSE BARB



PART #	BUNA (-B)	EPDM (-E)	VITON® (-F)
6S PVC-426-2B2B	6S PVC-426-2B2B-B	6S PVC-426-2B2B-E	6S PVC-426-2B2B-F
6S PVC-426-2B4B	6S PVC-426-2B4B-B	6S PVC-426-2B4B-E	6S PVC-426-2B4B-F
6S PVC-426-2B5B	6S PVC-426-2B5B-B	6S PVC-426-2B5B-E	6S PVC-426-2B5B-F
6S PVC-426-2B6B	6S PVC-426-2B6B-B	6S PVC-426-2B6B-E	6S PVC-426-2B6B-F
6S PVC-426-2B8B	6S PVC-426-2B8B-B	6S PVC-426-2B8B-E	6S PVC-426-2B8B-F
6S PVC-426-4B2B	6S PVC-426-4B2B-B	6S PVC-426-4B2B-E	6S PVC-426-4B2B-F
6S PVC-426-4B4B	6S PVC-426-4B4B-B	6S PVC-426-4B4B-E	6S PVC-426-4B4B-F
6S PVC-426-4B5B	6S PVC-426-4B5B-B	6S PVC-426-4B5B-E	6S PVC-426-4B5B-F
6S PVC-426-4B6B	6S PVC-426-4B6B-B	6S PVC-426-4B6B-E	6S PVC-426-4B6B-F
6S PVC-426-4B8B	6S PVC-426-4B8B-B	6S PVC-426-4B8B-E	6S PVC-426-4B8B-F
6S PVC-426-5B2B	6S PVC-426-5B2B-B	6S PVC-426-5B2B-E	6S PVC-426-5B2B-F
6S PVC-426-5B4B	6S PVC-426-5B4B-B	6S PVC-426-5B4B-E	6S PVC-426-5B4B-F
6S PVC-426-5B5B	6S PVC-426-5B5B-B	6S PVC-426-5B5B-E	6S PVC-426-5B5B-F
6S PVC-426-5B6B	6S PVC-426-5B6B-B	6S PVC-426-5B6B-E	6S PVC-426-5B6B-F

Continued on next page...

Specialty Valves: Plastic Check Valves – Series 426

PRICING CODE

6S

426 PVC HOSE BARB X HOSE BARB *continued*



PART #	BUNA (-B)	EPDM (-E)	VITON® (-F)
6S PVC-426-5B8B	6S PVC-426-5B8B-B	6S PVC-426-5B8B-E	6S PVC-426-5B8B-F
6S PVC-426-6B2B	6S PVC-426-6B2B-B	6S PVC-426-6B2B-E	6S PVC-426-6B2B-F
6S PVC-426-6B4B	6S PVC-426-6B4B-B	6S PVC-426-6B4B-E	6S PVC-426-6B4B-F
6S PVC-426-6B5B	6S PVC-426-6B5B-B	6S PVC-426-6B5B-E	6S PVC-426-6B5B-F
6S PVC-426-6B6B	6S PVC-426-6B6B-B	6S PVC-426-6B6B-E	6S PVC-426-6B6B-F
6S PVC-426-6B8B	6S PVC-426-6B8B-B	6S PVC-426-6B8B-E	6S PVC-426-6B8B-F
6S PVC-426-8B2B	6S PVC-426-8B2B-B	6S PVC-426-8B2B-E	6S PVC-426-8B2B-F
6S PVC-426-8B4B	6S PVC-426-8B4B-B	6S PVC-426-8B4B-E	6S PVC-426-8B4B-F
6S PVC-426-8B5B	6S PVC-426-8B5B-B	6S PVC-426-8B5B-E	6S PVC-426-8B5B-F
6S PVC-426-8B6B	6S PVC-426-8B6B-B	6S PVC-426-8B6B-E	6S PVC-426-8B6B-F
6S PVC-426-8B8B	6S PVC-426-8B8B-B	6S PVC-426-8B8B-E	6S PVC-426-8B8B-F

426 PVC HOSE BARB X PUSH-CONNECT



PART #	BUNA (-B)	EPDM (-E)	VITON® (-F)
6S PVC-426-2B4C	6S PVC-426-2B4C-B	6S PVC-426-2B4C-E	6S PVC-426-2B4C-F
6S PVC-426-2B6C	6S PVC-426-2B6C-B	6S PVC-426-2B6C-E	6S PVC-426-2B6C-F
6S PVC-426-4B4C	6S PVC-426-4B4C-B	6S PVC-426-4B4C-E	6S PVC-426-4B4C-F
6S PVC-426-4B6C	6S PVC-426-4B6C-B	6S PVC-426-4B6C-E	6S PVC-426-4B6C-F
6S PVC-426-5B4C	6S PVC-426-5B4C-B	6S PVC-426-5B4C-E	6S PVC-426-5B4C-F
6S PVC-426-5B6C	6S PVC-426-5B6C-B	6S PVC-426-5B6C-E	6S PVC-426-5B6C-F
6S PVC-426-6B4C	6S PVC-426-6B4C-B	6S PVC-426-6B4C-E	6S PVC-426-6B4C-F
6S PVC-426-6B6C	6S PVC-426-6B6C-B	6S PVC-426-6B6C-E	6S PVC-426-6B6C-F
6S PVC-426-8B4C	6S PVC-426-8B4C-B	6S PVC-426-8B4C-E	6S PVC-426-8B4C-F
6S PVC-426-8B6C	6S PVC-426-8B6C-B	6S PVC-426-8B6C-E	6S PVC-426-8B6C-F

426 PVC HOSE BARB X SMOOTH BARB



PART #	BUNA (-B)	EPDM (-E)	VITON® (-F)
6S PVC-426-2B6BIB	6S PVC-426-2B6BIB-B	6S PVC-426-2B6BIB-E	6S PVC-426-2B6BIB-F
6S PVC-426-4B6BIB	6S PVC-426-4B6BIB-B	6S PVC-426-4B6BIB-E	6S PVC-426-4B6BIB-F
6S PVC-426-5B6BIB	6S PVC-426-5B6BIB-B	6S PVC-426-5B6BIB-E	6S PVC-426-5B6BIB-F
6S PVC-426-6B6BIB	6S PVC-426-6B6BIB-B	6S PVC-426-6B6BIB-E	6S PVC-426-6B6BIB-F
6S PVC-426-8B6BIB	6S PVC-426-8B6BIB-B	6S PVC-426-8B6BIB-E	6S PVC-426-8B6BIB-F

426 PVC PUSH-CONNECT X FEMALE



PART #	BUNA (-B)	EPDM (-E)	VITON® (-F)
6S PVC-426-4C2F	6S PVC-426-4C2F-B	6S PVC-426-4C2F-E	6S PVC-426-4C2F-F
6S PVC-426-4C4F	6S PVC-426-4C4F-B	6S PVC-426-4C4F-E	6S PVC-426-4C4F-F

Specialty Valves: Plastic Check Valves – Series 426

PRICING CODE

6S

426 PVC PUSH-CONNECT X MALE



PART #	BUNA (-B)	EPDM (-E)	VITON® (-F)
6S PVC-426-4C2M	6S PVC-426-4C2M-B	6S PVC-426-4C2M-E	6S PVC-426-4C2M-F
6S PVC-426-4C4M	6S PVC-426-4C4M-B	6S PVC-426-4C4M-E	6S PVC-426-4C4M-F

426 PVC PUSH-CONNECT X HOSE BARB



PART #	BUNA (-B)	EPDM (-E)	VITON® (-F)
6S PVC-426-4C2B	6S PVC-426-4C2B-B	6S PVC-426-4C2B-E	6S PVC-426-4C2B-F
6S PVC-426-4C4B	6S PVC-426-4C4B-B	6S PVC-426-4C4B-E	6S PVC-426-4C4B-F
6S PVC-426-4C5B	6S PVC-426-4C5B-B	6S PVC-426-4C5B-E	6S PVC-426-4C5B-F
6S PVC-426-4C6B	6S PVC-426-4C6B-B	6S PVC-426-4C6B-E	6S PVC-426-4C6B-F
6S PVC-426-4C8B	6S PVC-426-4C8B-B	6S PVC-426-4C8B-E	6S PVC-426-4C8B-F

426 PVC PUSH-CONNECT X PUSH-CONNECT



PART #	BUNA (-B)	EPDM (-E)	VITON® (-F)
6S PVC-426-4C4C	6S PVC-426-4C4C-B	6S PVC-426-4C4C-E	6S PVC-426-4C4C-F
6S PVC-426-4C6C	6S PVC-426-4C6C-B	6S PVC-426-4C6C-E	6S PVC-426-4C6C-F

426 PVC PUSH-CONNECT X SMOOTH BARB



PART #	BUNA (-B)	EPDM (-E)	VITON® (-F)
6S PVC-426-6C6BIB	6S PVC-426-6C6BIB-B	6S PVC-426-6C6BIB-E	6S PVC-426-6C6BIB-F
6S PVC-426-4C6BIB	6S PVC-426-4C6BIB-B	6S PVC-426-4C6BIB-E	6S PVC-426-4C6BIB-F

Specialty Valves: Plastic Check Valves – Series 426

PRICING CODE

6S

426 PVC SMOOTH BARB X FEMALE



PART #	BUNA (-B)	EPDM (-E)	VITON® (-F)
6S PVC-426-6BIB2F	6S PVC-426-6BIB2F-B	6S PVC-426-6BIB2F-E	6S PVC-426-6BIB2F-F
6S PVC-426-6BIB4F	6S PVC-426-6BIB4F-B	6S PVC-426-6BIB4F-E	6S PVC-426-6BIB4F-F

426 PVC SMOOTH BARB X MALE



PART #	BUNA (-B)	EPDM (-E)	VITON® (-F)
6S PVC-426-6BIB2M	6S PVC-426-6BIB2M-B	6S PVC-426-6BIB2M-E	6S PVC-426-6BIB2M-F
6S PVC-426-6BIB4M	6S PVC-426-6BIB4M-B	6S PVC-426-6BIB4M-E	6S PVC-426-6BIB4M-F

426 PVC SMOOTH BARB X HOSE BARB



PART #	BUNA (-B)	EPDM (-E)	VITON® (-F)
6S PVC-426-6BIB2B	6S PVC-426-6BIB2B-B	6S PVC-426-6BIB2B-E	6S PVC-426-6BIB2B-F
6S PVC-426-6BIB4B	6S PVC-426-6BIB4B-B	6S PVC-426-6BIB4B-E	6S PVC-426-6BIB4B-F
6S PVC-426-6BIB5B	6S PVC-426-6BIB5B-B	6S PVC-426-6BIB5B-E	6S PVC-426-6BIB5B-F
6S PVC-426-6BIB6B	6S PVC-426-6BIB6B-B	6S PVC-426-6BIB6B-E	6S PVC-426-6BIB6B-F
6S PVC-426-6BIB8B	6S PVC-426-6BIB8B-B	6S PVC-426-6BIB8B-E	6S PVC-426-6BIB8B-F

426 PVC SMOOTH BARB X PUSH-CONNECT



PART #	BUNA (-B)	EPDM (-E)	VITON® (-F)
6S PVC-426-6BIB4C	6S PVC-426-6BIB4C-B	6S PVC-426-6BIB4C-E	6S PVC-426-6BIB4C-F
6S PVC-426-6BIB6C	6S PVC-426-6BIB6C-B	6S PVC-426-6BIB6C-E	6S PVC-426-6BIB6C-F

426 PVC SMOOTH BARB X SMOOTH BARB



PART #	BUNA (-B)	EPDM (-E)	VITON® (-F)
6S PVC-426-6BIB6BIB	6S PVC-426-6BIB6BIB-B	6S PVC-426-6BIB6BIB-E	6S PVC-426-6BIB6BIB-F

Specialty Valves: Polypropylene Check Valves

PRICING CODE | **6S**

FEATURES, APPLICATIONS AND NOTES:

- The 685/687 series polypropylene check valve operates in any position, horizontal or vertical.
- Standard cracking pressure less than 1 psi with a maximum operating pressure of 125 psi.
- Easily disassembled for repair or replacement of seals.
- Stainless steel spring, with guided polypropylene poppet. Hastelloy springs available.

Calculate your part number using the key below. 6S should precede your part number. (SAMPLE: 6SBP-685-8F8F-E1)

BP	-	685	-	8F	-	8F	-	E	-	1
MATERIAL OPTIONS		MODEL OPTIONS		INLET OPTIONS		OUTLET OPTIONS		SEAL TYPE OPTIONS		CRACKING PRESSURE OPTIONS
BP - Black Poly (Standard)		694 - 1/4" Body		4F - 1/4" FPT		4F - 1/4" FPT		B - Buna		1/3 PSI (Standard)
WFP - White Poly*		693 - 3/8" Body		6F - 3/8" FPT		6F - 3/8" FPT		E - EPDM		1 PSI
		685 - 1/2" Body		8F - 1/2" FPT		8F - 1/2" FPT		F - Viton®		3 PSI
		687 - 3/4" Body		12F - 3/4" FPT		12F - 3/4" FPT				7 PSI

*Call for pricing

FEMALE X FEMALE



PART #	CRACKING PRESSURE	BUNA (-B)	EPDM (-E)	VITON® (-F)
6S BP-694-4F4F	1/3 PSI	6S BP-694-4F4F-B	6S BP-694-4F4F-E	6S BP-694-4F4F-F
6S BP-694-4F4F	1,3 or 7 PSI	6S BP-694-4F4F-B	6S BP-694-4F4F-E	6S BP-694-4F4F-F
6S BP-693-6F6F	1/3 PSI	6S BP-693-6F6F-B	6S BP-693-6F6F-E	6S BP-693-6F6F-F
6S BP-693-6F6F	1,3 or 7 PSI	6S BP-693-6F6F-B	6S BP-693-6F6F-E	6S BP-693-6F6F-F
6S BP-685-8F8F	1/3 PSI	6S BP-685-8F8F-B	6S BP-685-8F8F-E	6S BP-685-8F8F-F
6S BP-685-8F8F	1,3 or 7 PSI	6S BP-685-8F8F-B	6S BP-685-8F8F-E	6S BP-685-8F8F-F
6S BP-687-12F12F	1/3 PSI	6S BP-687-12F12F-B	6S BP-687-12F12F-E	6S BP-687-12F12F-F
6S BP-687-12F12F	1,3 or 7 PSI	6S BP-687-12F12F-B	6S BP-687-12F12F-E	6S BP-687-12F12F-F

Specialty Valves: Polypropylene Check Valves

PRICING CODE

6S

FEMALE X MALE



PART #	CRACKING PRESSURE	BUNA (-B)	EPDM (-E)	VITON® (-F)
6S BP-685-8F8M	1/3 PSI	6S BP-685-8F8M-B	6S BP-685-8F8M-E	6S BP-685-8F8M-F
6S BP-685-8F8M	1,3 or 7 PSI	6S BP-685-8F8M-B	6S BP-685-8F8M-E	6S BP-685-8F8M-F

MALE X FEMALE



PART #	CRACKING PRESSURE	BUNA (-B)	EPDM (-E)	VITON® (-F)
6S BP-685-8M8F	1/3 PSI	6S BP-685-8M8F-B	6S BP-685-8M8F-E	6S BP-685-8M8F-F
6S BP-685-8M8F	1,3 or 7 PSI	6S BP-685-8M8F-B	6S BP-685-8M8F-E	6S BP-685-8M8F-F

MALE X MALE



PART #	CRACKING PRESSURE	BUNA (-B)	EPDM (-E)	VITON® (-F)
6S BP-685-8M8M	1/3 PSI	6S BP-685-8M8M-B	6S BP-685-8M8M-E	6S BP-685-8M8M-F
6S BP-685-8M8M	1,3 or 7 PSI	6S BP-685-8M8M-B	6S BP-685-8M8M-E	6S BP-685-8M8M-F

Specialty Valves: Miniature Check Valves

PRICING CODE | 6S

FEATURES, APPLICATIONS AND NOTES:

- The SMC Miniature check valve series is a general purpose check valve which operates in any position, horizontal or vertical.
- Standard cracking pressure 1 psi.
- Guided stainless steel ball and spring.

Calculate your part number using the key below. 6S should precede your part number. (SAMPLE: 6SPP-695-2B2B-E1/2)

PP	695	2B	2B	E	1/3
MATERIAL OPTIONS	MODEL OPTIONS	INLET OPTIONS	OUTLET OPTIONS	SEAL TYPE OPTIONS	CRACKING PRESSURE OPTIONS
PP - Polypropylene (Black)	695	2B - 1/8" Hose Barb	2M - 1/8" MPT	B - Buna	1/2 PSI
WN - White Nylon		3B - 3/16" Hose Barb	4M - 1/4" MPT	E - EPDM	0.7 PSI
PVDF - Black PVDF*		4B - 1/4" Hose Barb	2B - 1/8" Hose Barb	F - Viton®	1 PSI (Standard)
			3B - 3/16" Hose Barb		2 PSI
			4B - 1/4" Hose Barb		

*Call for pricing

MINIATURE CHECK VALVES (PP) HOSE BARB X HOSE BARB



PART #	BUNA (-B)	EPDM (-E)	VITON® (-F)
6S PP-695-2B2B	6S PP-695-2B2B-B	6S PP-695-2B2B-E	6S PP-695-2B2B-F
6S PP-695-2B3B	6S PP-695-2B3B-B	6S PP-695-2B3B-E	6S PP-695-2B3B-F
6S PP-695-2B4B	6S PP-695-2B4B-B	6S PP-695-2B4B-E	6S PP-695-2B4B-F
6S PP-695-3B2B	6S PP-695-3B2B-B	6S PP-695-3B2B-E	6S PP-695-3B2B-F
6S PP-695-3B3B	6S PP-695-3B3B-B	6S PP-695-3B3B-E	6S PP-695-3B3B-F
6S PP-695-3B4B	6S PP-695-3B4B-B	6S PP-695-3B4B-E	6S PP-695-3B4B-F
6S PP-695-4B2B	6S PP-695-4B2B-B	6S PP-695-4B2B-E	6S PP-695-4B2B-F
6S PP-695-4B3B	6S PP-695-4B3B-B	6S PP-695-4B3B-E	6S PP-695-4B3B-F
6S PP-695-4B4B	6S PP-695-4B4B-B	-E6S PP-695-4B4B	6S PP-695-4B4B-F

Specialty Valves: Miniature Check Valves

PRICING CODE

6S

MINIATURE CHECK VALVES (PP) HOSE BARB X MALE



PART #	BUNA (-B)	EPDM (-E)	VITON® (-F)
6S PP-695-2B2M	6S PP-695-2B2M-B	6S PP-695-2B2M-E	6S PP-695-2B2M-F
6S PP-695-3B2M	6S PP-695-3B2M-B	6S PP-695-3B2M-E	6S PP-695-3B2M-F
6S PP-695-4B2M	6S PP-695-4B2M-B	6S PP-695-4B2M-E	6S PP-695-4B2M-F

MINIATURE CHECK VALVES (WN) HOSE BARB X HOSE BARB



PART #	BUNA (-B)	EPDM (-E)	VITON® (-F)
6S WN-695-2B2B	6S WN-695-2B2B-B	6S WN-695-2B2B-E	6S WN-695-2B2B-F
6S WN-695-2B3B	6S WN-695-2B3B-B	6S WN-695-2B3B-E	6S WN-695-2B3B-F
6S WN-695-2B4B	6S WN-695-2B4B-B	6S WN-695-2B4B-E	6S WN-695-2B4B-F
6S WN-695-3B2B	6S WN-695-3B2B-B	6S WN-695-3B2B-E	6S WN-695-3B2B-F
6S WN-695-3B3B	6S WN-695-3B3B-B	6S WN-695-3B3B-E	6S WN-695-3B3B-F
6S WN-695-3B4B	6S WN-695-3B4B-B	6S WN-695-3B4B-E	6S WN-695-3B4B-F
6S WN-695-4B2B	6S WN-695-4B2B-B	6S WN-695-4B2B-E	6S WN-695-4B2B-F
6S WN-695-4B3B	6S WN-695-4B3B-B	6S WN-695-4B3B-E	6S WN-695-4B3B-F
6S WN-695-4B4B	6S WN-695-4B4B-B	6S WN-695-4B4B-E	6S WN-695-4B4B-F

MINIATURE CHECK VALVES (WN) HOSE BARB X MALE



PART #	BUNA (-B)	EPDM (-E)	VITON® (-F)
6S WN-695-2B2M	6S WN-695-2B2M-B	6S WN-695-2B2M-E	6S WN-695-2B2M-F
6S WN-695-3B2M	6S WN-695-3B2M-B	6S WN-695-3B2M-E	6S WN-695-3B2M-F
6S WN-695-4B2M	6S WN-695-4B2M-B	6S WN-695-4B2M-E	6S WN-695-4B2M-F

**THIS PAGE IS
INTENTIONALLY
LEFT BLANK**

Brass Ball Valves: Style 54 – Full Port

PRICING CODE

6R



FEATURES:

- Certified by NSF to NSF/ANSI Standard 6-1/8 1/4"-2"
- UL/FM approved 1/2" - 2"
- CSA approved 1/2" - 3"
- Full port design
- Adjustable stem packing gland
- 2-piece design
- Fluorocarbon elastomer stem O-ring seal
- Bottom loaded, Blowout proof design

PRESSURE RATED AT:

- 600 psi WOG, 150 psi WSP 1/4" - 2"
- 600 psi WOG, 125 psi WSP 1/4" - 3"

NOTE:

Price subject to change without notice

PART #	SIZE
6R B54FP025FF	1/4"
6R B54FP0375FF	3/8"
6R B54FP050FF	1/2"
6R B54FP075FF	3/4"
6R B54FP100FF	1"
6R B54FP125FF	1-1/4"
6R B54FP150FF	1-1/2"
6R B54FP200FF	2"
6R B54FP250FF	2-1/2"
6R B54FP300FF	3"
6R B54FP400FF	4"

Lead Free Brass Ball Valves: Style 54 – Full Port

PRICING CODE

6R



FEATURES:

- Certified by NSF to NSF/ANSI Standard 6 1/8
- UL/FM approved 1/2" -2"
- CSA approved 1/4" - 3"
- Full port design
- Adjustable stem packing gland
- 2-piece design
- PTFE Stem Packing Seal & Seats
- Fluorocarbon elastomer stem O-ring seal
- Bottom loaded, Blowout proof design
- Lead Free

PRESSURE RATED AT:

- 600 WOG, 150 WSP 1/4"- 2"
- 600 WOG, 125 WSP 1/4"- 3"

NOTE:

Price subject to change without notice

PART #	SIZE
6R LFB54FP025FF	1/4"
6R LFB54FP0375FF	3/8"
6R LFB54FP050FF	1/2"
6R LFB54FP075FF	3/4"
6R LFB54FP100FF	1"
6R LFB54FP125FF	1-1/4"
6R LFB54FP150FF	1-1/2"
6R LFB54FP200FF	2"
6R LFB54FP250FF	2-1/2"
6R LFB54FP300FF	3"

Lead Free Brass Ball Valves: Style 42 – Full Port Sweat

PRICING CODE

6R



FEATURES:

- Certified by NSF to NSF/ANSI Standard 6-1/8
- UL/FM approved 1/2" - 2"
- CSA approved 1/4" - 3"
- Full port design
- Adjustable stem packing gland
- 2-piece design
- PTFE Stem Packing Seal & Seats
- Fluorocarbon elastomer stem O-ring seal
- Bottom loaded, Blowout proof design
- Lead Free

PRESSURE RATED AT:

- 600 WOG, 150 WSP 1/4" - 2"
- 600 WOG, 125 WSP 1/4" - 3"

NOTE:

This valve is designed to be soft soldered into lines without disassembly, using a low temperature solder to (420°F / 216°C). Higher temperature solders may damage the seat material. Apply heat with the flame directed AWAY from the center of the valve body. Excessive heat can harm the seats. After soldering, the packing nut may have to be tightened.

PART #	SIZE
6R LFB42FP050SSW	1/2"
6R LFB42FP075SSW	3/4"
6R LFB42FP100SSW	1"
6R LFB42FP125SSW	1-1/4"
6R LFB42FP150SSW	1-1/2"
6R LFB42FP200SSW	2"

Brass Ball Valves: Style 93 – Full Port Hot-Forged Brass Exhaust Ball Valves With Lockable Handles

PRICING CODE **6R**

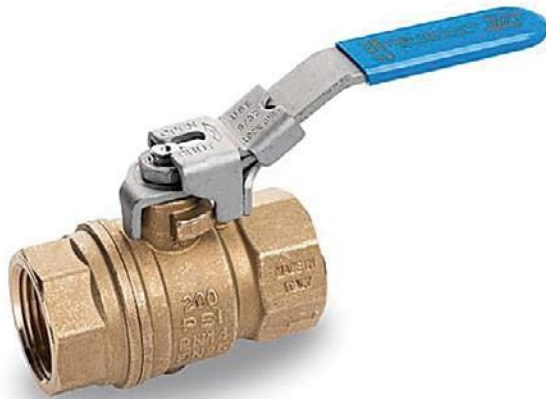

FEATURES:

- Patented Tamper-Proof Lockable Handle
- The Valve Body includes a down-Stream Depressurization Venting Outlet Topped 10-32 UNF to Direct Exhaust Air And Mounting Mufflers For Noise Control
- Blowout Proof Brass Stem
- Dacrotized Carbon Steel Lockable Handle With Hot PVC Deep Coating
- Hot Forged Sand Blasted Brass Body And Cap Sealed With LocTite
- Zero Leakage Guaranteed By 100% Seal Test
- Chrome Plated Brass Ball For Longer Life
- No Metal-To-Metal Moving Parts

PRESSURE RATED AT:

200 PSI / 8 bar Cold Water

TEMPERATURE RANGE:

-4°F to +350°F

PART #	SIZE
6R B93FP025FFLH	1/4"
6R B93FP0375FFLH	3/8"
6R B93FP050FFLH	1/2"
6R B93FP075FFLH	3/4"
6R B93FP100FFLH	1"

RuB Miniature Ball Valves

PRICING CODE

6R

FEATURES:

- One Piece Drawn Sand Blasted Body Brass With Very Compact Design
- UL Approved For Refrigerant Ball Valves In Accordance With UL 207 Standard
- Chrome Plated Brass Ball For Longer Life
- No Metal-To-Metal Moving Parts
- Blowout-Proof Brass Stem With Vitron O-Ring
- Nylon Black Wedge Handle Removable With
- Operating 450 PSI / 30 Bar Cold Water Pressure

TEMPERATURE:

-4°F to +200°F

STYLE 34 – 200 PSI

FEMALE X FEMALE



PART #	SIZE
6R B34SP0125FF	1/8"
6R B34SP025FF	1/4"
6R B34SP0375FF	3/8"
6R B34SP050FF	1/2"

MALE X FEMALE



PART #	SIZE
6R B34SP0125MF	1/8"
6R B34SP025MF	1/4"
6R B34SP0375MF	3/8"
6R B34SP050MF	1/2"

RuB Miniature Ball Valves

PRICING CODE

6R

STYLE 35 – 450 PSI

FEMALE X FEMALE



PART #	SIZE
6R B35SP0125FF	1/8"
6R B35SP025FF	1/4"
6R B35SP0375FF	3/8"
6R B35SP050FF	1/2"

MALE X FEMALE



PART #	SIZE
6R B35SP0125MF	1/8"
6R B35SP025MF	1/4"
6R B35SP0375MF	3/8"
6R B35SP050MF	1/2"

Stainless Steel Ball Valves – 1-PC Reduced Port, 1000 WOG

PRICING CODE

7M



FEATURES:

- 1000 PSI
- Blow-Out Proof Stem
- Pressure Balance Hole in Ball Slot
- Double Reduced Port
- Various Thread Standards Available
- Locking Device Available

PART #	SIZE
7M V-108-04	1/4"
7M V-108-06	3/8"
7M V-108-08	1/2"
7M V-108-12	3/4"
7M V-108-16	1"
7M V-108-20	1-1/4"
7M V-108-24	1-1/2"
7M V-108-32	2"

Stainless Steel Ball Valves – 2-PC Full Port, 1000 WOG

PRICING CODE

7M



FEATURES:

- 1000 PSI
- Blow-Out Proof Stem
- Pressure Balance Hole in Ball Slot
- Full Port
- Various Thread Standards Available
- Locking Handles

PART #	SIZE
7M V-210-FP-04LH	1/4"
7M V-210-FP-06LH	3/8"
7M V-210-FP-08LH	1/2"
7M V-210-FP-12LH	3/4"
7M V-210-FP-16LH	1"
7M V-210-FP-20LH	1-1/4"
7M V-210-FP-24LH	1-1/2"
7M V-210-FP-32LH	2"
7M V-210-FP-48LH	3"

Stainless Steel Ball Valves – 3-PC Full Port, 1000 WOG (Threaded & Socket Weld)

PRICING CODE

7M

**FEATURES:**

- 1000 PSI
- Blow-Out Proof Stem
- Pressure Balance Hole in Ball Slot
- Full Port
- Various Thread Standards Available
- Locking Handles
- Socket ends available, use the prefix 7M SWV-310

PART #	SIZE
7M V-310-FP-04	1/4"
7M V-310-FP-06	3/8"
7M V-310-FP-08	1/2"
7M V-310-FP-12	3/4"
7M V-310-FP-16	1"
7M V-310-FP-20	1-1/4"
7M V-310-FP-24	1-1/2"
7M V-310-FP-32	2"
7M V-310-FP-40	2-1/2"
7M V-310-FP-48	3"

NET PRICES - EFFECTIVE JULY 1, 2022

Stainless Steel Ball Valves – 2-PC Reduced Port 2000/1500 WOG

PRICING CODE

7M

**FEATURES:**

- 2000 PSI in 1/4"-1", 1500 PSI in 1-1/4"-2"
- Blow-Out Proof Stem
- Pressure Balance Hole in Ball Slot
- Various Thread Standards Available
- Locking Device Available

PART #	SIZE
7M V-220-04	1/4"
7M V-220-06	3/8"
7M V-220-08	1/2"
7M V-220-12	3/4"
7M V-220-16	1"
7M V-220-20	1-1/4"
7M V-220-24	1-1/2"
7M V-220-32	2"

NET PRICES - EFFECTIVE JULY 1, 2022

Polypropylene Ball Valves

PRICING CODE

6T

FEATURES:

- Precision molded in glass reinforced polypropylene for strength and chemical resistance
- PTFE seats for smooth and proper sealing characteristics
- Double O-rings in stem area for extra sealing protection
- Interlocking body and end plate to allow easy thread connection when installing valves

SINGLE UNION BALL VALVES



PART #	SIZE
6T UV050FP	1/2" FP
6T PS075FP	3/4" FP
6T PS100FP	1" FP
6T PS125FP	1-1/4" FP
6T PS150FP	1-1/2" FP
6T PS200FP	2" FP

LIST PRICES - EFFECTIVE JULY 1, 2022

Polypropylene Ball Valves

PRICING CODE

6T

FEATURES:

- Precision molded polypropylene is reinforced with fiberglass for additional strength
- FKM seals
- Self-aligning ball moves freely against the PTFE seats for smooth operation. The valve opens and closes with very little pressure on the handle
- Ball is diamond turned, after molding, to make it spherically perfect, which provides precise contact between ball and seats
- PTFE self-lubricating stem bushings and seats cannot stick or bind
- Stainless steel bolts

BOLTED BALL VALVES – STAINLESS STEEL BOLTS



PART #	SIZE
6T B050FP-S	1/2" FP
6T B075FP-S	3/4" FP
6T B100SP-S	1" SP
6T B100FP-S	1" FP
6T B125SP-S	1-1/4" SP
6T B125FP-S	1-1/4" FP
6T B150FP-S	1-1/2" FP
6T B200SP-S	2" SP
6T B200FP-S	2" FP
6T B300SP-S	3" SP
6T B300FP-S	3" FP
6T B400SP-S	4" SP

LIST PRICES - EFFECTIVE JULY 1, 2022

PVC Ball Valves

PRICING CODE

6Q



FEATURES:

- Low cost quarter turn, corrosion free
- FDA & NSF approved material
- 150 psi at 73°F
- EPDM O-Rings

APPLICATIONS:

- Water Plumbing for Industrial, Agricultural and Residential Purposes
- Chemical Supply Line for Waste Water Treatment as well as Chemical Plants

WHITE SCHEDULE 40 BODY – THREADED CONNECTIONS



PART #	SIZE
6Q MTWE 050	1/2"
6Q MTWE 075	3/4"
6Q MTWE 100	1"
6Q MTWE 125	1-1/4"
6Q MTWE 150	1-1/2"
6Q MTWE 200	2"

WHITE SCHEDULE 40 BODY – SOLVENT CONNECTIONS



PART #	SIZE
6Q MSWE 050	1/2"
6Q MSWE 075	3/4"
6Q MSWE 100	1"
6Q MSWE 125	1-1/4"
6Q MSWE 150	1-1/2"
6Q MSWE 200	2"

PVC Ball Valves

PRICING CODE

6Q



GRAY SCHEDULE 80 BODY – THREADED CONNECTIONS



PART #	SIZE
6Q MTGE 050	1/2"
6Q MTGE 075	3/4"
6Q MTGE 100	1"
6Q MTGE 125	1-1/4"
6Q MTGE 150	1-1/2"
6Q MTGE 200	2"

GRAY SCHEDULE 80 BODY – SOLVENT CONNECTIONS



PART #	SIZE
6Q MSGE 050	1/2"
6Q MSGE 075	3/4"
6Q MSGE 100	1"
6Q MSGE 125	1-1/4"
6Q MSGE 150	1-1/2"
6Q MSGE 200	2"

PVC Spring Check Valves

PRICING CODE

6B



FEATURES:

- Maintenance and Corrosion Free
- NSF Approved Materials
- 2lb. Stainless Steel Spring Compiles with All Applicable ASTM & ANSI Standards
- Molded in the U.S.A.

APPLICATIONS:

- Water Plumbing for Residential and Industrial Uses to Stop Back Flow in Swimming Pools, Hot Tubs, Spas, Cooling and Pumping Systems
- Industrial and Agricultural Irrigation

THREADED CONNECTIONS



SIZE	1/2 LB. CRACKING PRESSURE	2 LB. CRACKING PRESSURE	5 LB. CRACKING PRESSURE
	PART #	PART #	PART #
1/2"	6B KC-0500-T	6B KC2-0500-T	6B KC5-0500-T
3/4"	6B KC-0750-T	6B KC2-0750-T	6B KC5-0750-T
1"	6B KC-1000-T	6B KC2-1000-T	6B KC5-1000-T
1-1/4"	6B KC-1250-T	6B KC2-1250-T	6B KC5-1250-T
1-1/2"	6B KC-1500-T	6B KC2-1500-T	6B KC5-1500-T
2"	6B KC-2000-T	6B KC2-2000-T	6B KC5-2000-T

SOLVENT CONNECTIONS



SIZE	1/2 LB. CRACKING PRESSURE	2 LB. CRACKING PRESSURE
	PART #	PART #
1/2"	6B KC-0500-S	6B KC2-0500-S
3/4"	6B KC-0750-S	6B KC2-0750-S
1"	6B KC-1000-S	6B KC2-1000-S
1-1/4"	6B KC-1250-S	6B KC2-1250-S
1-1/2"	6B KC-1500-S	6B KC2-1500-S
2"	6B KC-2000-S	6B KC2-2000-S

**THIS PAGE IS
INTENTIONALLY
LEFT BLANK**

Needle & Misc Brass Valves

PRICING CODE

6A

FEMALE PIPE TO FEMALE PIPE

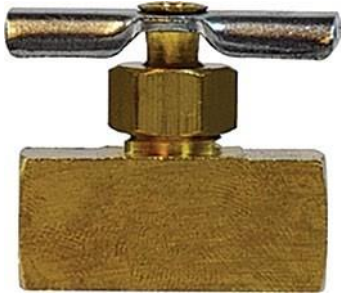

PART #	SIZE
6A 31NV	1/8" X 1/8"
6A 32NV	1/4" X 1/4"

COMPRESSION TO MALE PIPE, ANGLE



PART #	SIZE
6A 103CC	1/4" X 1/8"
6A 103-4CC	1/4" X 1/4"
6A 203CC	5/16" X 1/8"
6A 204CC	5/16" X 1/4"
6A 303CC	3/8" X 1/4"

FEMALE PIPE TO MALE PIPE

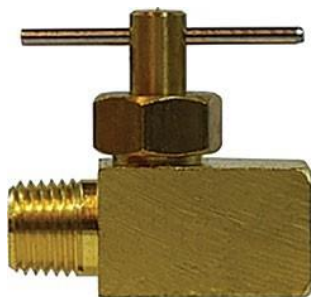

PART #	SIZE
6A 48NV	1/8" X 1/8"
6A 49NV	1/4" X 1/4"

Needle & Misc Brass Valves

PRICING CODE

6A

COMPRESSION TO MALE PIPE

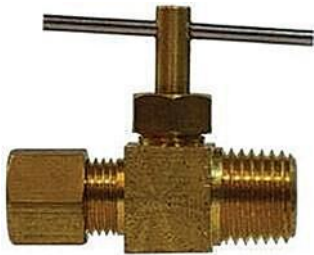

PART #	SIZE
6A 101CP	1/4" X 1/8"
6A 101CP-4	1/4" X 1/4"
6A 143CP	3/8" X 1/4"

FLARE TO FLARE



PART #	SIZE
6A 110SAE	1/4" X 1/4"
6A 115SAE	3/8" X 3/8"

MALE PIPE TO MALE PIPE



PART #	SIZE
6A 108MP	1/8" X 1/8"
6A 110MP	1/4" X 1/4"

COMPRESSION TO COMPRESSION

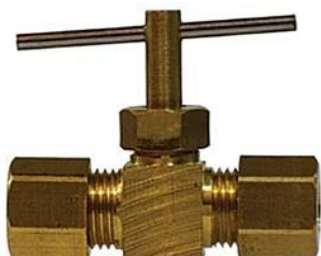

PART #	SIZE
6A 107CC	5/16" X 5/16"
6A 113CC	3/8" X 3/8"

Shut Off Cocks

PRICING CODE | 6A

FEATURES:

- Neoprene "O" Ring seal
- Solid Bottom
- Steel Cadmium Plated Handle
- For use on Fuel Oil, Water, Gas, Air, L.P. Gas, etc.

NOTE:

Price subject to change without notice

COMPRESSION TO MPT



PART #	SIZE
6A 27CSD	1/4" X 1/8"
6A 227CSD	1/4" X 1/4"
6A 57CSD	3/8" X 1/4"

FLARE TO MPT

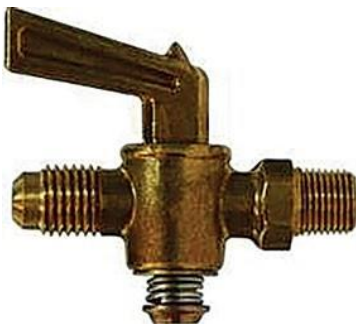

PART #	SIZE
6A 27SD	1/4" X 1/8"
6A 29SD	5/16" X 1/8"
6A 57SD	3/8" X 1/4"
6A 67SD	1/2" X 3/8"

Shut Off Cocks

PRICING CODE

6A

COMPRESSION TO COMPRESSION

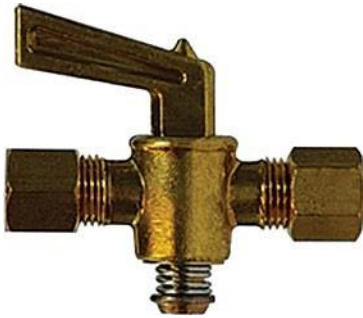

PART #	SIZE
6A 28CSD	1/4" X 1/4"
6A 30CSD	5/16" X 5/16"
6A 58CSD	3/8" X 3/8"
6A 68CSD	1/2" X 1/2"

FLARE TO FLARE

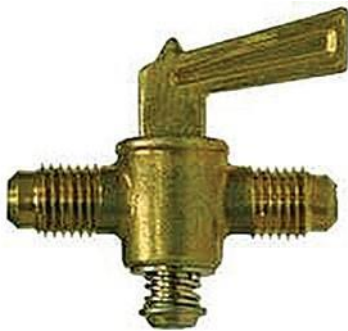

PART #	SIZE
6A 28SD	1/4" X 1/4"
6A 30SD	5/16" X 5/16"
6A 68SD	1/2" X 1/2"

FEMALE PIPE TO FEMALE PIPE

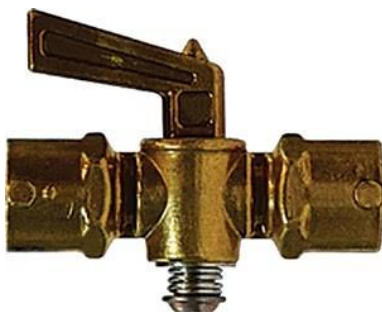

PART #	SIZE
6A 31SD	1/8" X 1/8"
6A 32SD	1/4" X 1/4"
6A 40SD	3/8" X 3/8"

Drain Cocks & Drain Valves

PRICING CODE

6A

DRAIN COCK - INTERNAL SEAT, PIN HANDLE



PART #	SIZE
6A 200D	1/8"
6A 201D	1/4"
6A 202D	3/8"

NEEDLE DRAIN COCK WITH HOSE BIBB



PART #	SIZE
6A 201DH	1/4"

DRAIN COCK - INTERNAL SEAT, WING NUT HANDLE



PART #	SIZE
6A 300D	1/8"

Drain Cocks & Drain Valves

PRICING CODE 6A

DRAIN COCK - EXTERNAL SEAT, RADIATOR TYPE



PART #	SIZE
6A 320D	1/8"
6A 321D	1/4"
6A 322 D	3/8"

T HANDLE DRAIN VALVE



PART #	SIZE
6A 37D	1/8"
6A 38D	1/4"

LEVER HANDLE DRAIN VALVE



PART #	SIZE
6A 41D	1/8"
6A 42D	1/4"
6A 43D	3/8"
6A 44D	1/2"

MISC STYLES

PRICING CODE	DESCRIPTION	PAGE
9R	In-Line Strainers	G1
9R	In-Line Strainer Spare Parts	G6
9R	Suction Screens	G10
9B	Polypropylene Y Strainers	G11
9P	Pressure Gauges	G14
9T	PTFE Thread Tape	G27
2X/8J	Hose & Tubing Cutters	G29
9J	Greases & Lubricants	G31



**THIS PAGE IS
INTENTIONALLY
LEFT BLANK**

In-Line Strainers

PRICING CODE | 9R

FEATURES:

In-line strainers have been the industry standard for cost effective straining and filtering since they were first introduced over thirty years ago.

APPLICATIONS:

- Agricultural Sprayers
- Pressure Washers
- Floor Scrubbers
- Pre-Filters
- Not for use with residential water systems.



Calculate your part number using the key below. 9R should precede your part number. (SAMPLE: 9RN02520VCLPMXM)

N	025	20	V	W	FXF
MATERIAL OPTIONS	INLET / OUTLET SIZE OPTIONS	MESH GAUGE OPTIONS	SEAL MATERIAL OPTIONS	BOWL MATERIAL OPTIONS	INLET / OUTLET TYPE OPTIONS
N - White Nylon	025 - 1/4"	20 - 20 Mesh	V - Viton	W - White Nylon	FXF - Female NPT x Female NPT
P - Black Polypropylene	038 - 3/8"	40 - 40 Mesh	E - EPT	B - Black Polypropylene	MXM - Male NPT x Male NPT*
	050 - 1/2"	80 - 80 Mesh w/ Polypropylene Cage	B - Buna**	C - Clear Nylon	GXG - Push-Connect x Push-Connect*
	075 - 3/4"	120 - 120 Mesh**		WLP - White Nylon Low Profile	
	100 - 1"			BLP - Black Polypropylene Low Profile	
	125 - 1 1/4"			CLP - Clear Nylon Low Profile	
	150 - 1 1/2"				

*Available on Low Profile Bodies

**Call for Pricing

In-Line Strainers

PRICING CODE

9R

WHITE NYLON TOP: WHITE BOWL

	SIZE / THREAD	EPT SEALS			VITON SEALS		
		20 MESH	40 MESH	80 MESH	20 MESH	40 MESH	80 MESH
FXF	3/8"	9RN03820EWF XF	9RN03840EWF XF	9RN03880EWF XF	9RN03820VWF XF	9RN03840VWF XF	9RN03880VWF XF
	1/2"	9RN05020EWF XF	9RN05040EWF XF	9RN05080EWF XF	9RN05020VWF XF	9RN05040VWF XF	9RN05080VWF XF
	3/4"	9RN07520EWF XF	9RN07540EWF XF	9RN07580EWF XF	9RN07520VWF XF	9RN07540VWF XF	9RN07580VWF XF
	1"	9RN10020EWF XF	9RN10040EWF XF	9RN10080EWF XF	9RN10020VWF XF	9RN10040VWF XF	9RN10080VWF XF
	1-1/4"	9RN12520EWF XF	9RN12540EWF XF	9RN12580EWF XF	9RN12520VWF XF	9RN12540VWF XF	9RN12580VWF XF
	1-1/2"	9RN15020EWF XF	9RN15040EWF XF	9RN15080EWF XF	9RN15020VWF XF	9RN15040VWF XF	9RN15080VWF XF

*80 Mesh has outer cage for 1" to 1-1/2" sized strainers
 **50 Mesh is substituted for 40 Mesh on 1-1/2" sized strainers.

WHITE NYLON TOP: CLEAR BOWL

	SIZE / THREAD	EPT SEALS			VITON SEALS		
		20 MESH	40 MESH	80 MESH	20 MESH	40 MESH	80 MESH
FXF	3/8"	9RN03820ECF XF	9RN03840ECF XF	9RN03880ECF XF	9RN03820VCF XF	9RN03840VCF XF	9RN03880VCF XF
	1/2"	9RN05020ECF XF	9RN05040ECF XF	9RN05080ECF XF	9RN05020VCF XF	9RN05040VCF XF	9RN05080VCF XF
	3/4"	9RN07520ECF XF	9RN07540ECF XF	9RN07580ECF XF	9RN07520VCF XF	9RN07540VCF XF	9RN07580VCF XF
	1"	9RN10020ECF XF	9RN10040ECF XF	9RN10080ECF XF	9RN10020VCF XF	9RN10040VCF XF	9RN10080VCF XF
	1-1/4"	9RN12520ECF XF	9RN12540ECF XF	9RN12580ECF XF	9RN12520VCF XF	9RN12540VCF XF	9RN12580VCF XF
	1-1/2"	9RN15020ECF XF	9RN15040ECF XF	9RN15080ECF XF	9RN15020VCF XF	9RN15040VCF XF	9RN15080VCF XF

*80 Mesh has outer cage for 1" to 1-1/2" sized strainers
 **50 Mesh is substituted for 40 Mesh on 1-1/2" sized strainers.

✓ = available

In-Line Strainers

PRICING CODE 9R

WHITE NYLON TOP: WHITE LOW PROFILE BOWL

	SIZE / THREAD	EPT SEALS			VITON SEALS		
		20 MESH	40 MESH	80 MESH	20 MESH	40 MESH	80 MESH
MXM	1/4"	9RN02520EWLPMXM	9RN02540EWLPMXM	9RN02580EWLPMXM	9RN02520VWLPMXM	9RN02540VWLPMXM	9RN02580VWLPMXM
	3/8"	9RN03820EWLPMXM	9RN03840EWLPMXM	9RN03880EWLPMXM	9RN03820VWLPMXM	9RN03840VWLPMXM	9RN03880VWLPMXM
	1/2"	9RN05020EWLPMXM	9RN05040EWLPMXM	9RN05080EWLPMXM	9RN05020VWLPMXM	9RN05040VWLPMXM	9RN05080VWLPMXM
FXF	3/8"	9RN03820EWLPFXF	9RN03840EWLPFXF	9RN03880EWLPFXF	9RN03820VWLPFXF	9RN03840VWLPFXF	9RN03880VWLPFXF
	1/2"	9RN05020EWLPFXF	9RN05040EWLPFXF	9RN05080EWLPFXF	9RN05020VWLPFXF	9RN05040VWLPFXF	9RN05080VWLPFXF
PUSH CONNECT	1/4"	9RN02520EWLPGXG	9RN02540EWLPGXG	9RN02580EWLPGXG	9RN02520VWLPGXG	9RN02540VWLPGXG	9RN02580VWLPGXG
	3/8"	9RN03820EWLPGXG	9RN03840EWLPGXG	9RN03880EWLPGXG	9RN03820VWLPGXG	9RN03840VWLPGXG	9RN03880VWLPGXG

WHITE NYLON TOP: CLEAR LOW PROFILE BOWL

	SIZE / THREAD	EPT SEALS			VITON SEALS		
		20 MESH	40 MESH	80 MESH	20 MESH	40 MESH	80 MESH
MXM	1/4"	9RN02520ECLPMXM	9RN02540ECLPMXM	9RN02580ECLPMXM	9RN02520VCLPMXM	9RN02540VCLPMXM	9RN02580VCLPMXM
	3/8"	9RN03820ECLPMXM	9RN03840ECLPMXM	9RN03880ECLPMXM	9RN03820VCLPMXM	9RN03840VCLPMXM	9RN03880VCLPMXM
	1/2"	9RN05020ECLPMXM	9RN05040ECLPMXM	9RN05080ECLPMXM	9RN05020VCLPMXM	9RN05040VCLPMXM	9RN05080VCLPMXM
FXF	3/8"	9RN03820ECLPFXF	9RN03840ECLPFXF	9RN03880ECLPFXF	9RN03820VCLPFXF	9RN03840VCLPFXF	9RN03880VCLPFXF
	1/2"	9RN05020ECLPFXF	9RN05040ECLPFXF	9RN05080ECLPFXF	9RN05020VCLPFXF	9RN05040VCLPFXF	9RN05080VCLPFXF
PUSH CONNECT	1/4"	9RN02520ECLPGXG	9RN02540ECLPGXG	9RN02580ECLPGXG	9RN02520VCLPGXG	9RN02540VCLPGXG	9RN02580VCLPGXG
	3/8"	9RN03820ECLPGXG	9RN03840ECLPGXG	9RN03880ECLPGXG	9RN03820VCLPGXG	9RN03840VCLPGXG	9RN03880VCLPGXG

In-Line Strainers

PRICING CODE

9R

BLACK POLYPROPYLENE TOP: BLACK BOWL

	SIZE / THREAD	EPT SEALS			VITON SEALS		
		20 MESH	40 MESH	80 MESH	20 MESH	40 MESH	80 MESH
FXF	3/8"	9RP03820EBFXF	9RP03840EBFXF	9RP03880EBFXF	9RP03820VBFXF	9RP03840VBFXF	9RP03880VBFXF
	1/2"	9RP05020EBFXF	9RP05040EBFXF	9RP05080EBFXF	9RP05020VBFXF	9RP05040VBFXF	9RP05080VBFXF
	3/4"	9RP07520EBFXF	9RP07540EBFXF	9RP07580EBFXF	9RP07520VBFXF	9RP07540VBFXF	9RP07580VBFXF
	1"	9RP10020EBFXF	9RP10040EBFXF	9RP10080EBFXF	9RP10020VBFXF	9RP10040VBFXF	9RP10080VBFXF
	1-1/4"	9RP12520EBFXF	9RP12540EBFXF	9RP12580EBFXF	9RP12520VBFXF	9RP12540VBFXF	9RP12580VBFXF
	1-1/2"	9RP15020EBFXF	9RP15040EBFXF	9RP15080EBFXF	9RP15020VBFXF	9RP15040VBFXF	9RP15080VBFXF

*80 Mesh has outer cage for 1" to 1-1/2" sized strainers

**50 Mesh is substituted for 40 Mesh on 1-1/2" sized strainers.

BLACK POLYPROPYLENE TOP: CLEAR BOWL

	SIZE / THREAD	EPT SEALS			VITON SEALS		
		20 MESH	40 MESH	80 MESH	20 MESH	40 MESH	80 MESH
FXF	3/8"	9RP03820ECFXF	9RP03840ECFXF	9RP03880ECFXF	9RP03820VCFXF	9RP03840VCFXF	9RP03880VCFXF
	1/2"	9RP05020ECFXF	9RP05040ECFXF	9RP05080ECFXF	9RP05020VCFXF	9RP05040VCFXF	9RP05080VCFXF
	3/4"	9RP07520ECFXF	9RP07540ECFXF	9RP07580ECFXF	9RP07520VCFXF	9RP07540VCFXF	9RP07580VCFXF
	1"	9RP10020ECFXF	9RP10040ECFXF	9RP10080ECFXF	9RP10020VCFXF	9RP10040VCFXF	9RP10080VCFXF
	1-1/4"	9RP12520ECFXF	9RP12540ECFXF	9RP12580ECFXF	9RP12520VCFXF	9RP12540VCFXF	9RP12580VCFXF
	1-1/2"	9RP15020ECFXF	9RP15040ECFXF	9RP15080ECFXF	9RP15020VCFXF	9RP15040VCFXF	9RP15080VCFXF

*80 Mesh has outer cage for 1" to 1-1/2" sized strainers

**50 Mesh is substituted for 40 Mesh on 1-1/2" sized strainers.

In-Line Strainers

PRICING CODE

9R

BLACK POLYPROPYLENE TOP: BLACK LOW PROFILE BOWL

	SIZE / THREAD	EPT SEALS			VITON SEALS		
		20 MESH	40 MESH	80 MESH	20 MESH	40 MESH	80 MESH
MXM	1/4"	9RP02520EBLPMXM	9RP02540EBLPMXM	9RP02580EBLPMXM	9RP02520VBLPMXM	9RP02540VBLPMXM	9RP02580VBLPMXM
	3/8"	9RP03820EBLPMXM	9RP03840EBLPMXM	9RP03880EBLPMXM	9RP03820VBLPMXM	9RP03840VBLPMXM	9RP03880VBLPMXM
	1/2"	9RP05020EBLPMXM	9RP05040EBLPMXM	9RP05080EBLPMXM	9RP05020VBLPMXM	9RP05040VBLPMXM	9RP05080VBLPMXM
FXF	3/8"	9RP03820EBLPFXF	9RP03840EBLPFXF	9RP03880EBLPFXF	9RP03820VBLPFXF	9RP03840VBLPFXF	9RP03880VBLPFXF
	1/2"	9RP05020EBLPFXF	9RP05040EBLPFXF	9RP05080EBLPFXF	9RP05020VBLPFXF	9RP05040VBLPFXF	9RP05080VBLPFXF
PUSH CONNECT	1/4"	9RP02520EBLPGXG	9RP02540EBLPGXG	9RP02580EBLPGXG	9RP02520VBLPGXG	9RP02540VBLPGXG	9RP02580VBLPGXG
	3/8"	9RP03820EBLPGXG	9RP03840EBLPGXG	9RP03880EBLPGXG	9RP03820VBLPGXG	9RP03840VBLPGXG	9RP03880VBLPGXG

BLACK POLYPROPYLENE TOP: CLEAR LOW PROFILE BOWL

	SIZE / THREAD	EPT SEALS			VITON SEALS		
		20 MESH	40 MESH	80 MESH	20 MESH	40 MESH	80 MESH
MXM	1/4"	9RP02520ECLPMXM	9RP02540ECLPMXM	9RP02580ECLPMXM	9RP02520VCLPMXM	9RP02540VCLPMXM	9RP02580VCLPMXM
	3/8"	9RP03820ECLPMXM	9RP03840ECLPMXM	9RP03880ECLPMXM	9RP03820VCLPMXM	9RP03840VCLPMXM	9RP03880VCLPMXM
	1/2"	9RP05020ECLPMXM	9RP05040ECLPMXM	9RP05080ECLPMXM	9RP05020VCLPMXM	9RP05040VCLPMXM	9RP05080VCLPMXM
FXF	3/8"	9RP03820ECLPFXF	9RP03840ECLPFXF	9RP03880ECLPFXF	9RP03820VCLPFXF	9RP03840VCLPFXF	9RP03880VCLPFXF
	1/2"	9RP05020ECLPFXF	9RP05040ECLPFXF	9RP05080ECLPFXF	9RP05020VCLPFXF	9RP05040VCLPFXF	9RP05080VCLPFXF
PUSH CONNECT	1/4"	9RP02520ECLPGXG	9RP02540ECLPGXG	9RP02580ECLPGXG	9RP02520VCLPGXG	9RP02540VCLPGXG	9RP02580VCLPGXG
	3/8"	9RP03820ECLPGXG	9RP03840ECLPGXG	9RP03880ECLPGXG	9RP03820VCLPGXG	9RP03840VCLPGXG	9RP03880VCLPGXG

In-Line Strainer Spare Parts

PRICING CODE

9R

FEATURES:

In-line strainers have been the industry standard for cost effective straining and filtering since they were first introduced over thirty years ago.

APPLICATIONS:

- Agricultural Sprayers
- Pressure Washers
- Floor Scrubbers
- Pre-Filters
- Not for use with residential water systems.

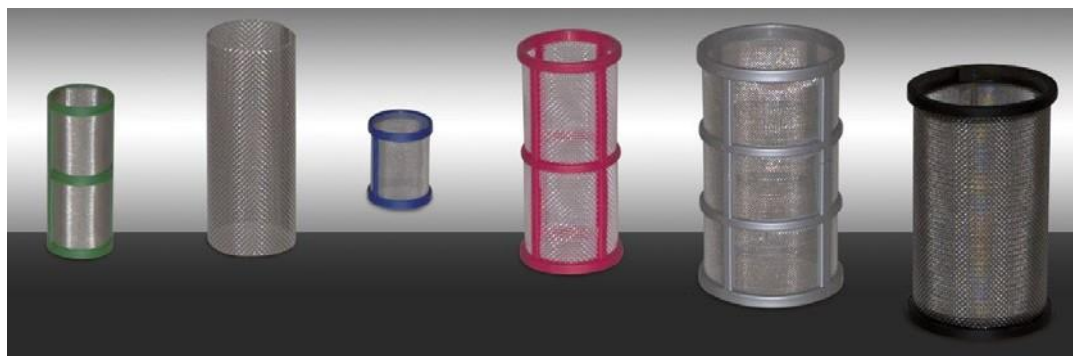

REPLACEMENT STRAINER SCREENS

SIZE	20 MESH	40 MESH	50 MESH	80 MESH
1/2"	9RSM05020LP	9RSM05040LP	9RSM05050LP *	9RSM05080LP
3/4"	9RSM07520	9RSM07540	9RSM07550P	9RSM07580
1"	9RSM10020	9RSM10040	-	9RSM10080P
1-1/4"	9RSM12520	9RSM12540	-	9RSM12580P
1-1/2"	9RSM15020	-	9RSM15050P	9RSM15080P

LP indicates Low Profile, P indicates a polypropylene outer cage
 * 50 Mesh in Low Profile also has poly cage
 Note: Other screen options may be available, call for availability and pricing.

In-Line Strainer Spare Parts

PRICING CODE

9R



REPLACEMENT STRAINER BOWLS

	SIZE	PART NUMBER
White Nylon	1/2"	9RSBWLP
	3/4"	9RSBWSM
	1"	9RSBWLGP
Black Polypropylene	1/2"	9RSBBLP
	3/4"	9RSBBSM
	1"	9RSBBLGP
Clear Nylon	1/2"	9RSBCLP
	3/4"	9RSBCSM
	1"	9RSBCLGP

LP indicates Low Profile

In-Line Strainer Spare Parts

PRICING CODE

9R



REPLACEMENT STRAINER TOPS FOR STANDARD BOWLS

	SIZE	PART NUMBER
Nylon	3/8"	9RSTN038
	1/2"	9RSTN050
	3/4"	9RSTN075
	1"	9RSTN100
	1-1/4"	9RSTN125
	1-1/2"	9RSTN150
Polypropylene	3/8"	9RSTP038
	1/2"	9RSTP050
	3/4"	9RSTP075
	1"	9RSTP100
	1-1/4"	9RSTP125
	1-1/2"	9RSTP150

REPLACEMENT STRAINER TOPS FOR LOW PROFILE BOWLS

	SIZE	BARB	FEMALE	MALE	PUSH-CONNECT
Nylon - Low Profile	1/4"	-	9RSTN025FLP	9RSTN025MLP	9RSTN025GLP
	3/8"	9RSTN038BLP	9RSTN038FLP	9RSTN038MLP	9RSTN038GLP
	1/2"	9RSTN050BLP	9RSTN050FLP	9RSTN050MLP	-
Polypropylene - Low Profile	1/4"	-	9RSTP025FLP	9RSTP025MLP	-
	3/8"	-	9RSTP038FLP	9RSTP038MLP	9RSTP038GLP
	1/2"	-	-	-	-

In-Line Strainer Spare Parts

PRICING CODE

9R

REPLACEMENT STRAINER GASKETS

	SIZE	PART NUMBER
Buna	1/2"	9RSGB050LP
	3/4"	9RSGB075
EPT	1/2"	9RSGE050LP
	3/4"	9RSGE075
	1"	9RSGE100
Viton	1/2"	9RSGV050LP
	3/4"	9RSGV075
	1"	9RSGV100

LP indicates for use with Low Profile

Suction Screens

PRICING CODE

9R

FEATURES:

- We offer a line of PVC* suction strainers in various connection and mesh sizes.
- Our PVC suction strainers are rated for a maximum temperature of 120°F.

APPLICATIONS:

- Pool and Spa Equipment
- Water Softeners
- Floor Cleaning Machinery
- Pressure Washers
- Car Wash Equipment

*Nylon available, call for pricing and availability.

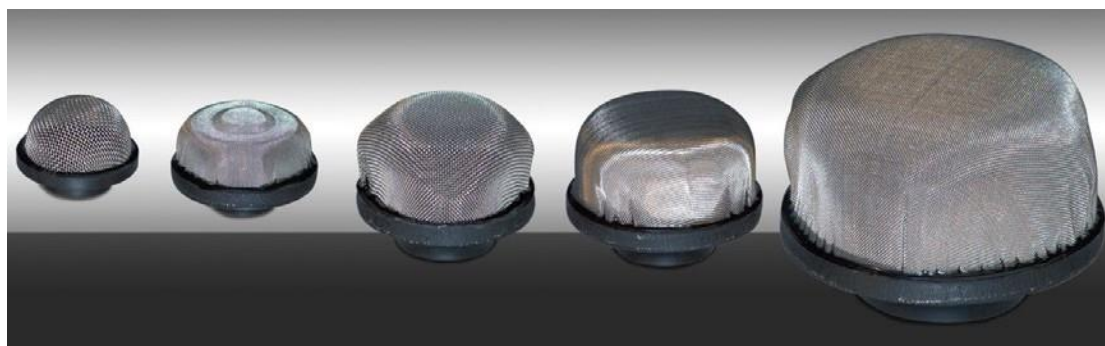

SUCTION SCREENS

THREAD SIZE X MESH SIZE	PART NUMBER
1/4" X 30 MESH	9RSM02530S
1/4" X 40 MESH	9RSM02540S
1/2" X 10 MESH	9RSM05010S
1/2" X 40 MESH	9RSM05040S
3/4" X 40 MESH	9RSM07540S
3/4" X 50 MESH	9RSM07550S
3/4" X 80 MESH	9RSM07580S
1" X 20 MESH	9RSM10020S
1" X 80 MESH	9RSM10080S
1-1/4" X 20 MESH	9RSM12520S
1-1/2" X 80 MESH	9RSM15080S

Polypropylene “Y” Strainers

PRICING CODE

9B

FEATURES:

- Precision Molded Construction
- Corrosion Resistant
- Fiberglass Reinforced
- 75 PSI Sizes 1/2" to 1-1/4"
- 150 PSI Sizes 1-1/2" to 2"

NOTE:

Call for additional mesh options

PART #	SIZE
9B YP050-20	1/2" X 20 MESH
9B YP050-40	1/2" X 40 MESH
9B YP050-80	1/2" X 80/20 MESH
9B YP075-20	3/4" X 20 MESH
9B YP075-40	3/4" X 40 MESH
9B YP075-80	3/4" X 80/20 MESH
9B YP100-20	1" X 20 MESH
9B YP100-40	1" X 40 MESH
9B YP100-80	1" X 80/20 MESH
9B YP125-20	1-1/4" X 20 MESH
9B YP125-40	1-1/4" X 40 MESH
9B YP125-80	1-1/4" X 80/20 MESH
9B YP150-20	1-1/2" X 20 MESH
9B YP150-50	1-1/2" X 50 MESH
9B YP150-80	1-1/2" X 80/20 MESH
9B YP200-20	2" X 20 MESH
9B YP200-50	2" X 50 MESH
9B YP200-80	2" X 80/20 MESH

**THIS PAGE IS
INTENTIONALLY
LEFT BLANK**

Precision Instrument Part Numbering System

PRICING CODE

9P

Calculate your part number using the key below. (SAMPLE: 201L-254E)

2	0	1	L	25	4	E
TYPE SERIES	SPECIAL FEATURES	MOUNTING STYLE	TYPE FILLING	DIAL SIZE	CONN. SIZE	PRESSURE RANGES
1 = Steel Case w/ Chrome Ring Brass Internals	0 = Standard Gauge	1 = Bottom Connection Stem Mounted	D = Dry Gauge- Not Filled	15 = 1 1/2" Diameter	8 = 1/8" NPT Male	A = 30/0"hg Vac CB = 30/0/15 PSI CC = 30/0/30 PSI CD = 30/0/60 PSI
2 = Stainless Steel Case Brass Internals	1 = Removable Ring, Adjustable Pointer	2 = Back Connection Stem Mounted	L = Glycerine Filled	20 = 2" Diameter	4 = 1/4" NPT Male	CE = 30/0/100 PSI CF = 30/0/150 PSI CG = 30/0/200 PSI CH = 30/0/300 PSI
3 = Stainless Steel Case 316 SS Internals		3 = Back Connection U-Clamp, Panel Mounted	S = Silicone Filled	25 = 2 1/2" Diameter	2 = 1/2" NPT Male	B = 0/15 PSI C = 0/30 PSI D = 0/60 PSI E = 0/100 PSI F = 0/160 PSI G = 0/200 PSI H = 0/300 PSI I = 0/400 PSI J = 0/500 PSI K = 0/600 PSI L = 0/800 PSI M = 0/1000 PSI N = 0/1500 PSI O = 0/2000 PSI P = 0/3000 PSI Q = 0/4000 PSI R = 0/5000 PSI S = 0/6000 PSI U = 0/10,000 PSI V = 0/15,000 PSI
4 = Ammonia Gauge Steel SKT, STST Tube		4 = Back Connection Front Flanged, Panel Mounted		35 = 3 1/2" Diameter		
5 = Brass Case Brass Internals		5 = Bottom Connection Back Flanged, Wall Mounted		40 = 4" Diameter		
				45 = 4 1/2" Diameter		
				60 = 6" Diameter		

Pressure Gauges

TYPE 101D | Steel Case, Dry – Bottom Mount

PRICING CODE

9P



FEATURES:

- Steel Case, Chrome Bezel, Plastic Lens
- Brass Tube and Socket, Lower-Mount

CONNECTION SIZES:

- 1/8" Thread Size on 1-1/2" Dial Size
- 1/8" and 1/4" Thread Sizes on 2" Dial Size
- 1/4" Thread Size on 2-1/2" thru 4-1/2" Dial Sizes

NOTES:

- Due to the ongoing import tariffs, a 11.25% surcharge will be applied to all orders, effective 9/4/2019 until further notice.
- 3-1/2-4-1/2": Call for Pricing

PRESSURES	Dial Size		
	1-1/2"	2"	2-1/2"
A = 30/0" hg VAC	9P101D-158A	9P101D-208A	9P101D-254A
CB = 30/0/15 PSI	9P101D-158CB	9P101D-208CB	9P101D-254CB
CC = 30/0/30 PSI	9P101D-158CC	9P101D-208CC	9P101D-254CC
CD = 30/0/60 PSI	9P101D-158CD	9P101D-208CD	9P101D-254CD
CE = 30/0/100 PSI	9P101D-158CE	9P101D-208CE	9P101D-254CE
CF = 30/0/150 PSI	9P101D-158CF	9P101D-208CF	9P101D-254CF
CG = 30/0/200 PSI	9P101D-158CG	9P101D-208CG	9P101D-254CG
CH = 30/0/300 PSI	9P101D-158CH	9P101D-208CH	9P101D-254CH
B = 0/15 PSI	9P101D-158B	9P101D-208B	9P101D-254B
C = 0/30 PSI	9P101D-158C	9P101D-208C	9P101D-254C
D = 0/60 PSI	9P101D-158D	9P101D-208D	9P101D-254D
E = 0/100 PSI	9P101D-158E	9P101D-208E	9P101D-254E
F = 0/160 PSI	9P101D-158F	9P101D-208F	9P101D-254F
G = 0/200 PSI	9P101D-158G	9P101D-208G	9P101D-254G
H = 0/300 PSI	9P101D-158H	9P101D-208H	9P101D-254H
I = 0/400 PSI	9P101D-158I	9P101D-208I	9P101D-254I
J = 0/500 PSI	9P101D-158J	9P101D-208J	9P101D-254J
K = 0/600 PSI	9P101D-158K	9P101D-208K	9P101D-254K
L = 0/800 PSI	X	X	9P101D-254L
M = 0/1000 PSI	X	X	9P101D-254M
N = 0/1500 PSI	X	X	9P101D-254N
O = 0/2000 PSI	X	X	9P101D-254O
P = 0/3000 PSI	X	X	9P101D-254P
Q = 0/4000 PSI	X	X	9P101D-254Q
R = 0/5000 PSI	X	X	9P101D-254R
S = 0/6000 PSI	X	X	9P101D-254S

Pressure Gauges

TYPE 102 D | Steel Case, Dry – Center-Back Mount

PRICING CODE

9P



FEATURES:

- Steel Case, Chrome Bezel, Plastic Lens
- Brass Tube and Socket, Center-Back Mount

CONNECTION SIZES:

- 1/8" Thread Size on 1-1/2" Dial Size
- 1/8" and 1/4" Thread Sizes on 2" Dial Size
- 1/4" Thread Size on 2-1/2" Dial Size

NOTE:

Due to the ongoing import tariffs, a 11.25% surcharge will be applied to all orders, effective 9/4/2019 until further notice.

PRESSURES	Dial Size		
	1-1/2"	2"	2-1/2"
A = 30/0" hg VAC	9P102D-158A	9P102D-208A	9P102D-254A
CB = 30/0/15 PSI	9P102D-158CB	9P102D-208CB	9P102D-254CB
CC = 30/0/30 PSI	9P102D-158CC	9P102D-208CC	9P102D-254CC
CD = 30/0/60 PSI	9P102D-158CD	9P102D-208CD	9P102D-254CD
CE = 30/0/100 PSI	9P102D-158CE	9P102D-208CE	9P102D-254CE
CF = 30/0/150 PSI	9P102D-158CF	9P102D-208CF	9P102D-254CF
CG = 30/0/200 PSI	9P102D-158CG	9P102D-208CG	9P102D-254CG
CH = 30/0/300 PSI	9P102D-158CH	9P102D-208CH	9P102D-254CH
B = 0/15 PSI	9P102D-158B	9P102D-208B	9P102D-254B
C = 0/30 PSI	9P102D-158C	9P102D-208C	9P102D-254C
D = 0/60 PSI	9P102D-158D	9P102D-208D	9P102D-254D
E = 0/100 PSI	9P102D-158E	9P102D-208E	9P102D-254E
F = 0/160 PSI	9P102D-158F	9P102D-208F	9P102D-254F
G = 0/200 PSI	9P102D-158G	9P102D-208G	9P102D-254G
H = 0/300 PSI	9P102D-158H	9P102D-208H	9P102D-254H
I = 0/400 PSI	9P102D-158I	9P102D-208I	9P102D-254I
J = 0/500 PSI	9P102D-158J	9P102D-208J	9P102D-254J
K = 0/600 PSI	9P102D-158K	9P102D-208K	9P102D-254K
L = 0/800 PSI	X	X	9P102D-254L
M = 0/1000 PSI	X	X	9P102D-254M
N = 0/1500 PSI	X	X	9P102D-254N
O = 0/2000 PSI	X	X	9P102D-254O
P = 0/3000 PSI	X	X	9P102D-254P
Q = 0/4000 PSI	X	X	9P102D-254Q
R = 0/5000 PSI	X	X	9P102D-254R
S = 0/6000 PSI	X	X	9P102D-254S

Pressure Gauges

TYPE 103 D | Steel Case, Dry – Center-Back Mount w/ U-Clamp

PRICING CODE

9P



FEATURES:

- Steel Case, Chrome Bezel, Plastic Lens
- Brass Tube and Socket, Center-Back Mount w/ U-Clamp

CONNECTION SIZES:

- 1/8" Thread Size on 1-1/2" Dial Size
- 1/8" and 1/4" Thread Sizes on 2" Dial Size
- 1/4" Thread Size on 2-1/2" and 3-1/2" Dial Sizes

NOTE:

Due to the ongoing import tariffs, a 11.25% surcharge will be applied to all orders, effective 9/4/2019 until further notice.

PRESSURES	Dial Size			
	1-1/2"	2"	2-1/2"	3-1/2"
A = 30/0" hg VAC	9P103D-158A	9P103D-208A	9P103D-254A	9P103D-354A
CB = 30/0/15 PSI	9P103D-158CB	9P103D-208CB	9P103D-254CB	9P103D-354CB
CC = 30/0/30 PSI	9P103D-158CC	9P103D-208CC	9P103D-254CC	9P103D-354CC
CD = 30/0/60 PSI	9P103D-158CD	9P103D-208CD	9P103D-254CD	9P103D-354CD
CE = 30/0/100 PSI	9P103D-158CE	9P103D-208CE	9P103D-254CE	9P103D-354CE
CF = 30/0/150 PSI	9P103D-158CF	9P103D-208CF	9P103D-254CF	9P103D-354CF
CG = 30/0/200 PSI	9P103D-158CG	9P103D-208CG	9P103D-254CG	9P103D-354CG
CH = 30/0/300 PSI	9P103D-158CH	9P103D-208CH	9P103D-254CH	9P103D-354CH
B = 0/15 PSI	9P103D-158B	9P103D-208B	9P103D-254B	9P103D-354B
C = 0/30 PSI	9P103D-158C	9P103D-208C	9P103D-254C	9P103D-354C
D = 0/60 PSI	9P103D-158D	9P103D-208D	9P103D-254D	9P103D-354D
E = 0/100 PSI	9P103D-158E	9P103D-208E	9P103D-254E	9P103D-354E
F = 0/160 PSI	9P103D-158F	9P103D-208F	9P103D-254F	9P103D-354F
G = 0/200 PSI	9P103D-158G	9P103D-208G	9P103D-254G	9P103D-354G
H = 0/300 PSI	9P103D-158H	9P103D-208H	9P103D-254H	9P103D-354H
I = 0/400 PSI	X	X	9P103D-254I	9P103D-354I
J = 0/500 PSI	X	X	9P103D-254J	9P103D-354J
K = 0/600 PSI	X	X	9P103D-254K	9P103D-354K
L = 0/800 PSI	X	X	9P103D-254L	9P103D-354L
M = 0/1000 PSI	X	X	9P103D-254M	9P103D-354M
N = 0/1500 PSI	X	X	9P103D-254N	9P103D-354N
O = 0/2000 PSI	X	X	9P103D-254O	9P103D-354O
P = 0/3000 PSI	X	X	9P103D-254P	9P103D-354P
Q = 0/4000 PSI	X	X	9P103D-254Q	9P103D-354Q
R = 0/5000 PSI	X	X	9P103D-254R	9P103D-354R
S = 0/6000 PSI	X	X	9P103D-254S	9P103D-354S

Pressure Gauges

Type 201 L | Stainless Case, Liquid Filled – Bottom Mount

PRICING CODE **9P**



FEATURES:

- STST Case, Crimped on Bezel, Plastic Lens
- Brass Tube and Socket, Lower-Mount

CONNECTION SIZES:

- 1/4" Thread Size on 2" and 2-1/2" Dial Sizes
- 1/4", 1/2" Thread Size on 4" Dial Size

NOTE:

Due to the ongoing import tariffs, a 11.25% surcharge will be applied to all orders, effective 9/4/2019 until further notice.

PRESSURES	Dial Size		
	2"	2-1/2"	4"
A = 30/0" hg VAC	9P201L-204A	9P201L-254A	9P201L-404A
CB = 30/0/15 PSI	9P201L-204CB	9P201L-254CB	9P201L-404CB
CC = 30/0/30 PSI	9P201L-204CC	9P201L-254CC	9P201L-404CC
CD = 30/0/60 PSI	9P201L-204CD	9P201L-254CD	9P201L-404CD
CE = 30/0/100 PSI	9P201L-204CE	9P201L-254CE	9P201L-404CE
CF = 30/0/150 PSI	9P201L-204CF	9P201L-254CF	9P201L-404CF
CG = 30/0/200 PSI	9P201L-204CG	9P201L-254CG	9P201L-404CG
CH = 30/0/300 PSI	9P201L-204CH	9P201L-254CH	9P201L-404CH
B = 0/15 PSI	9P201L-204B	9P201L-254B	9P201L-404B
C = 0/30 PSI	9P201L-204C	9P201L-254C	9P201L-404C
D = 0/60 PSI	9P201L-204D	9P201L-254D	9P201L-404D
E = 0/100 PSI	9P201L-204E	9P201L-254E	9P201L-404E
F = 0/160 PSI	9P201L-204F	9P201L-254F	9P201L-404F
G = 0/200 PSI	9P201L-204G	9P201L-254G	9P201L-404G
H = 0/300 PSI	9P201L-204H	9P201L-254H	9P201L-404H
I = 0/400 PSI	9P201L-204I	9P201L-254I	9P201L-404I
J = 0/500 PSI	9P201L-204J	9P201L-254J	9P201L-404J
K = 0/600 PSI	9P201L-204K	9P201L-254K	9P201L-404K
L = 0/800 PSI	X	X	9P201L-404L
M = 0/1000 PSI	X	9P201L-254M	9P201L-404M
N = 0/1500 PSI	X	9P201L-254N	9P201L-404N
O = 0/2000 PSI	X	9P201L-254O	9P201L-404O
P = 0/3000 PSI	X	9P201L-254P	9P201L-404P
Q = 0/4000 PSI	X	X	9P201L-404Q
R = 0/5000 PSI	X	9P201L-254R	9P201L-404R
S = 0/6000 PSI	X	9P201L-254S	9P201L-404S
U = 0/10000 PSI	X	9P201L-254U	9P201L-404U
V = 0/15000 PSI	X	X	9P201L-404V

Pressure Gauges

Type 202 L | Stainless Case, Liquid Filled – Center-Back Mount

PRICING CODE **9P**



FEATURES:

- STST Case, Crimped on Bezel, Plastic Lens
- Brass Tube and Socket, Center-Back Mount

CONNECTION SIZES:

- 1/8" Thread Size on 1-1/2" Dial Size
- 1/8", 1/4" Thread Size on 2" Dial Size
- 1/4" Thread Size on 2-1/2" and 4" Dial Sizes
- *212L (Push-Twist on Bezel) Available

NOTE:

Due to the ongoing import tariffs, a 11.25% surcharge will be applied to all orders, effective 9/4/2019 until further notice.

PRESSURES	Dial Size			
	1-1/2"	2"	2-1/2"	4"
A = 30/0" hg VAC	9P202L-158A	9P202L-208A	9P202L-254A	9P202L-404A
CB = 30/0/15 PSI	9P202L-158CB	9P202L-208CB	9P202L-254CB	9P202L-404CB
CC = 30/0/30 PSI	9P202L-158CC	9P202L-208CC	9P202L-254CC	9P202L-404CC
CD = 30/0/60 PSI	9P202L-158CD	9P202L-208CD	9P202L-254CD	9P202L-404CD
CE = 30/0/100 PSI	9P202L-158CE	9P202L-208CE	9P202L-254CE	9P202L-404CE
CF = 30/0/150 PSI	9P202L-158CF	9P202L-208CF	9P202L-254CF	9P202L-404CF
CG = 30/0/200 PSI	9P202L-158CG	9P202L-208CG	9P202L-254CG	9P202L-404CG
CH = 30/0/300 PSI	9P202L-158CH	9P202L-208CH	9P202L-254CH	9P202L-404CH
B = 0/15 PSI	9P202L-158B	9P202L-208B	9P202L-254B	9P202L-404B
C = 0/30 PSI	9P202L-158C	9P202L-208C	9P202L-254C	9P202L-404C
D = 0/60 PSI	9P202L-158D	9P202L-208D	9P202L-254D	9P202L-404D
E = 0/100 PSI	9P202L-158E	9P202L-208E	9P202L-254E	9P202L-404E
F = 0/160 PSI	9P202L-158F	9P202L-208F	9P202L-254F	9P202L-404F
G = 0/200 PSI	9P202L-158G	9P202L-208G	9P202L-254G	9P202L-404G
H = 0/300 PSI	9P202L-158H	9P202L-208H	9P202L-254H	9P202L-404H
I = 0/400 PSI	9P202L-158I	9P202L-208I	9P202L-254I	9P202L-404I
J = 0/500 PSI	9P202L-158J	9P202L-208J	9P202L-254J	9P202L-404J
K = 0/600 PSI	9P202L-158K	9P202L-208K	9P202L-254K	9P202L-404K
L = 0/800 PSI	X	X	9P202L-254L	9P202L-404L
M = 0/1000 PSI	X	X	9P202L-254M	9P202L-404M
N = 0/1500 PSI	X	X	9P202L-254N	9P202L-404N
O = 0/2000 PSI	X	X	9P202L-254O	9P202L-404O
P = 0/3000 PSI	X	X	9P202L-254P	9P202L-404P
Q = 0/4000 PSI	X	X	9P202L-254Q	9P202L-404Q
R = 0/5000 PSI	X	X	9P202L-254R	9P202L-404R
S = 0/6000 PSI	X	X	9P202L-254S	9P202L-404S
U = 0/10000 PSI	X	X	9P202L-254U	9P202L-404U
V = 0/15000 PSI	X	X	9P202L-254V	9P202L-404V

Pressure Gauges

Type 203 L | Stainless Case, Liquid Filled – Center-Back Mount w/ U-Clamp

PRICING CODE **9P**



FEATURES:

- STST Case, Crimped on Bezel, Plastic Lens
- Brass Tube and Socket, Center-Back Mount w/ U-Clamp

CONNECTION SIZES:

- 1/8" Thread Size on 1-1/2" Dial Size
- 1/8", 1/4" Thread Size on 2" Dial Size
- 1/4" Thread Size on 2-1/2" and 4" Dial Sizes

NOTES:

- Due to the ongoing import tariffs, a 11.25% surcharge will be applied to all orders, effective 9/4/2019 until further notice.

PRESSURES	Dial Size			
	1-1/2"	2"	2-1/2"	4"
A = 30/0" hg VAC	9P203L-158A	9P203L-208A	9P203L-254A	9P203L-404A
CB = 30/0/15 PSI	9P203L-158CB	9P203L-208CB	9P203L-254CB	9P203L-404CB
CC = 30/0/30 PSI	9P203L-158CC	9P203L-208CC	9P203L-254CC	9P203L-404CC
CD = 30/0/60 PSI	9P203L-158CD	9P203L-208CD	9P203L-254CD	9P203L-404CD
CE = 30/0/100 PSI	9P203L-158CE	9P203L-208CE	9P203L-254CE	9P203L-404CE
CF = 30/0/150 PSI	9P203L-158CF	9P203L-208CF	9P203L-254CF	9P203L-404CF
CG = 30/0/200 PSI	9P203L-158CG	9P203L-208CG	9P203L-254CG	9P203L-404CG
CH = 30/0/300 PSI	9P203L-158CH	9P203L-208CH	9P203L-254CH	9P203L-404CH
B = 0/15 PSI	9P203L-158B	9P203L-208B	9P203L-254B	9P203L-404B
C = 0/30 PSI	9P203L-158C	9P203L-208C	9P203L-254C	9P203L-404C
D = 0/60 PSI	9P203L-158D	9P203L-208D	9P203L-254D	9P203L-404D
E = 0/100 PSI	9P203L-158E	9P203L-208E	9P203L-254E	9P203L-404E
F = 0/160 PSI	9P203L-158F	9P203L-208F	9P203L-254F	9P203L-404F
G = 0/200 PSI	9P203L-158G	9P203L-208G	9P203L-254G	9P203L-404G
H = 0/300 PSI	9P203L-158H	9P203L-208H	9P203L-254H	9P203L-404H
I = 0/400 PSI	9P203L-158I	9P203L-208I	9P203L-254I	9P203L-404I
J = 0/500 PSI	9P203L-158J	9P203L-208J	9P203L-254J	9P203L-404J
K = 0/600 PSI	9P203L-158K	9P203L-208K	9P203L-254K	9P203L-404K
L = 0/800 PSI	X	X	9P203L-254L	9P203L-404L
M = 0/1000 PSI	X	X	9P203L-254M	9P203L-404M
N = 0/1500 PSI	X	X	9P203L-254N	9P203L-404N
O = 0/2000 PSI	X	X	9P203L-254O	9P203L-404O
P = 0/3000 PSI	X	X	9P203L-254P	9P203L-404P
Q = 0/4000 PSI	X	X	9P203L-254Q	9P203L-404Q
R = 0/5000 PSI	X	X	9P203L-254R	9P203L-404R
S = 0/6000 PSI	X	X	9P203L-254S	9P203L-404S

Pressure Gauges

Type 204 L | Stainless Case, Liquid Filled – Center-Back Mount w/ Panel-Flange

PRICING CODE

9P



FEATURES:

- STST Case, Crimped on Bezel, Plastic Lens
- Brass Tube and Socket, CBM Front Flange

CONNECTION SIZES:

- 1-1/2", 2", 2-1/2", 4" (1/8", 1/4" NPT)
- (1/8", 1/4" NPT) on 2"
- (1/4" NPT) on 2-1/2", 4"

NOTES:

- Due to the ongoing import tariffs, a 11.25% surcharge will be applied to all orders, effective 9/4/2019 until further notice.
- 1-1/2", 2": Call for Pricing

PRESSURES	Dial Size	
	2-1/2"	4"
A = 30/0" hg VAC	9P204L-254A	9P204L-404A
CB = 30/0/15 PSI	9P204L-254CB	9P204L-404CB
CC = 30/0/30 PSI	9P204L-254CC	9P204L-404CC
CD = 30/0/60 PSI	9P204L-254CD	9P204L-404CD
CE = 30/0/100 PSI	9P204L-254CE	9P204L-404CE
CF = 30/0/150 PSI	9P204L-254CF	9P204L-404CF
CG = 30/0/200 PSI	9P204L-254CG	9P204L-404CG
CH = 30/0/300 PSI	9P204L-254CH	9P204L-404CH
B = 0/15 PSI	9P204L-254B	9P204L-404B
C = 0/30 PSI	9P204L-254C	9P204L-404C
D = 0/60 PSI	9P204L-254D	9P204L-404D
E = 0/100 PSI	9P204L-254E	9P204L-404E
F = 0/160 PSI	9P204L-254F	9P204L-404F
G = 0/200 PSI	9P204L-254G	9P204L-404G
H = 0/300 PSI	9P204L-254H	9P204L-404H
I = 0/400 PSI	9P204L-254I	9P204L-404I
J = 0/500 PSI	9P204L-254J	9P204L-404J
K = 0/600 PSI	9P204L-254K	9P204L-404K
L = 0/800 PSI	9P204L-254L	9P204L-404L
M = 0/1000 PSI	9P204L-254M	9P204L-404M
N = 0/1500 PSI	9P204L-254N	9P204L-404N
O = 0/2000 PSI	9P204L-254O	9P204L-404O
P = 0/3000 PSI	9P204L-254P	9P204L-404P
Q = 0/4000 PSI	9P204L-254Q	9P204L-404Q
R = 0/5000 PSI	9P204L-254R	9P204L-404R
S = 0/6000 PSI	9P204L-254S	9P204L-404S
U = 0/10000 PSI	X	9P204L-404U
V = 0/15000 PSI	X	9P204L-404V

Pressure Gauges

Type 301D/L | All Stainless, Liquid Filled or Dry – Bottom Mount

PRICING CODE

9P



FEATURES:

- STST Case, 316STST Tube & Socket
- Lower-Mount w/ Crimped on Bezel
- Plastic Lens

CONNECTION SIZES:

- 1/4" Thread Size on 2-1/2" Dial Size
- 1/4" and 1/2" Thread Size on 4" Dial Size
- *312L (push-Twist on Bezel Available)

NOTE:

Due to the ongoing import tariffs, a 11.25% surcharge will be applied to all orders, effective 9/4/2019 until further notice.

PRESSURES	301D		301L	
	Dial Size 2-1/2"	Dial Size 4"	Dial Size 2-1/2"	Dial Size 4"
A = 30/0" hg VAC	9P301D-254A	9P301D-404A	9P301L-254A	9P301L-404A
CB = 30/0/15 PSI	9P301D-254CB	9P301D-404CB	9P301L-254CB	9P301L-404CB
CC = 30/0/30 PSI	9P301D-254CC	9P301D-404CC	9P301L-254CC	9P301L-404CC
CD = 30/0/60 PSI	9P301D-254CD	9P301D-404CD	9P301L-254CD	9P301L-404CD
CE = 30/0/100 PSI	9P301D-254CE	9P301D-404CE	9P301L-254CE	9P301L-404CE
CF = 30/0/150 PSI	9P301D-254CF	9P301D-404CF	9P301L-254CF	9P301L-404CF
CG = 30/0/200 PSI	9P301D-254CG	9P301D-404CG	9P301L-254CG	9P301L-404CG
CH = 30/0/300 PSI	9P301D-254CH	9P301D-404CH	9P301L-254CH	9P301L-404CH
B = 0/15 PSI	9P301D-254B	9P301D-404B	9P301L-254B	9P301L-404B
C = 0/30 PSI	9P301D-254C	9P301D-404C	9P301L-254C	9P301L-404C
D = 0/60 PSI	9P301D-254D	9P301D-404D	9P301L-254D	9P301L-404D
E = 0/100 PSI	9P301D-254E	9P301D-404E	9P301L-254E	9P301L-404E
F = 0/160 PSI	9P301D-254F	9P301D-404F	9P301L-254F	9P301L-404F
G = 0/200 PSI	9P301D-254G	9P301D-404G	9P301L-254G	9P301L-404G
H = 0/300 PSI	9P301D-254H	9P301D-404H	9P301L-254H	9P301L-404H
I = 0/400 PSI	9P301D-254I	9P301D-404I	9P301L-254I	9P301L-404I
J = 0/500 PSI	9P301D-254J	9P301D-404J	9P301L-254J	9P301L-404J
K = 0/600 PSI	9P301D-254K	9P301D-404K	9P301L-254K	9P301L-404K
L = 0/800 PSI	9P301D-254L	9P301D-404L	9P301L-254L	9P301L-404L
M = 0/1000 PSI	9P301D-254M	9P301D-404M	9P301L-254M	9P301L-404M
N = 0/1500 PSI	9P301D-254N	9P301D-404N	9P301L-254N	9P301L-404N
O = 0/2000 PSI	9P301D-254O	9P301D-404O	9P301L-254O	9P301L-404O
P = 0/3000 PSI	9P301D-254P	9P301D-404P	9P301L-254P	9P301L-404P
Q = 0/4000 PSI	9P301D-254Q	9P301D-404Q	9P301L-254Q	9P301L-404Q
R = 0/5000 PSI	9P301D-254R	9P301D-404R	9P301L-254R	9P301L-404R
S = 0/6000 PSI	9P301D-254S	9P301D-404S	9P301L-254S	9P301L-404S
U = 0/10000 PSI	9P301D-254U	9P301D-404U	9P301L-254U	9P301L-404U
V = 0/15000 PSI	9P301D-254V	9P301D-404V	9P301L-254V	9P301L-404V

Pressure Gauges

Type 302D/L | All Stainless, Liquid Filled or Dry – Center-Back Mount

PRICING CODE

9P



FEATURES:

- STST Case, 316STST Tube & Socket
- Center-Back Mount w/ Crimped on Bezel
- Plastic Lens

CONNECTION SIZES:

- 1/4" Thread Size on 2-1/2" Dial Size
- *312L (push-Twist on Bezel Available)

NOTE:

Due to the ongoing import tariffs, a 11.25% surcharge will be applied to all orders, effective 9/4/2019 until further notice.

PRESSURES	302D	302L
	Dial Size 2-1/2"	Dial Size 2-1/2"
A = 30/0" hg VAC	9P302D-254A	9P302L-254A
CB = 30/0/15 PSI	9P302D-254CB	9P302L-254CB
CC = 30/0/30 PSI	9P302D-254CC	9P302L-254CC
CD = 30/0/60 PSI	9P302D-254CD	9P302L-254CD
CE = 30/0/100 PSI	9P302D-254CE	9P302L-254CE
CF = 30/0/150 PSI	9P302D-254CF	9P302L-254CF
CG = 30/0/200 PSI	9P302D-254CG	9P302L-254CG
CH = 30/0/300 PSI	9P302D-254CH	9P302L-254CH
B = 0/15 PSI	9P302D-254B	9P302L-254B
C = 0/30 PSI	9P302D-254C	9P302L-254C
D = 0/60 PSI	9P302D-254D	9P302L-254D
E = 0/100 PSI	9P302D-254E	9P302L-254E
F = 0/160 PSI	9P302D-254F	9P302L-254F
G = 0/200 PSI	9P302D-254G	9P302L-254G
H = 0/300 PSI	9P302D-254H	9P302L-254H
I = 0/400 PSI	9P302D-254I	9P302L-254I
J = 0/500 PSI	9P302D-254J	9P302L-254J
K = 0/600 PSI	9P302D-254K	9P302L-254K
L = 0/800 PSI	9P302D-254L	9P302L-254L
M = 0/1000 PSI	9P302D-254M	9P302L-254M
N = 0/1500 PSI	9P302D-254N	9P302L-254N
O = 0/2000 PSI	9P302D-254O	9P302L-254O
P = 0/3000 PSI	9P302D-254P	9P302L-254P
Q = 0/4000 PSI	9P302D-254Q	9P302L-254Q
R = 0/5000 PSI	9P302D-254R	9P302L-254R
S = 0/6000 PSI	9P302D-254S	9P302L-254S
U = 0/10000 PSI	9P302D-254U	9P302L-254U
V = 0/15000 PSI	9P302D-254V	9P302L-254V

Pressure Gauges

Type 303D/L | All Stainless, Liquid Filled or Dry – Center-Back Mount w/ U-Clamp

PRICING CODE **9P**



FEATURES:

- STST Case, Crimped on Bezel, Plastic Lens
- Stainless Tube and Socket, Center-Back Mount w/ U-Clamp

CONNECTION SIZES:

1/4" Thread Size on 2-1/2" Dial Size

NOTE:

Due to the ongoing import tariffs, a 11.25% surcharge will be applied to all orders, effective 9/4/2019 until further notice.

PRESSURES	303D	303L
	Dial Size 2-1/2"	Dial Size 2-1/2"
A = 30/0" hg VAC	9P303D-254A	9P303L-254A
CB = 30/0/15 PSI	9P303D-254CB	9P303L-254CB
CC = 30/0/30 PSI	9P303D-254CC	9P303L-254CC
CD = 30/0/60 PSI	9P303D-254CD	9P303L-254CD
CE = 30/0/100 PSI	9P303D-254CE	9P303L-254CE
CF = 30/0/150 PSI	9P303D-254CF	9P303L-254CF
CG = 30/0/200 PSI	9P303D-254CG	9P303L-254CG
CH = 30/0/300 PSI	9P303D-254CH	9P303L-254CH
B = 0/15 PSI	9P303D-254B	9P303L-254B
C = 0/30 PSI	9P303D-254C	9P303L-254C
D = 0/60 PSI	9P303D-254D	9P303L-254D
E = 0/100 PSI	9P303D-254E	9P303L-254E
F = 0/160 PSI	9P303D-254F	9P303L-254F
G = 0/200 PSI	9P303D-254G	9P303L-254G
H = 0/300 PSI	9P303D-254H	9P303L-254H
I = 0/400 PSI	9P303D-254I	9P303L-254I
J = 0/500 PSI	9P303D-254J	9P303L-254J
K = 0/600 PSI	9P303D-254K	9P303L-254K
L = 0/800 PSI	9P303D-254L	9P303L-254L
M = 0/1000 PSI	9P303D-254M	9P303L-254M
N = 0/1500 PSI	9P303D-254N	9P303L-254N
O = 0/2000 PSI	9P303D-254O	9P303L-254O
P = 0/3000 PSI	9P303D-254P	9P303L-254P
Q = 0/4000 PSI	9P303D-254Q	9P303L-254Q
R = 0/5000 PSI	9P303D-254R	9P303L-254R
S = 0/6000 PSI	9P303D-254S	9P303L-254S
U = 0/10000 PSI	9P303D-254U	9P303L-254U
V = 0/15000 PSI	9P303D-254V	9P303L-254V

Pressure Gauges

Type 304D/L | All Stainless, Liquid Filled or Dry – Center-Back Mount w/ Panel-Flange

PRICING CODE

9P



FEATURES:

- STST Case, Crimped on Bezel, Plastic Lens
- Stainless Tube and Socket, Center-Back Mount w/ Panel-Flange

CONNECTION SIZES:

Sizes: 2-1/2" (1/4" Thread Size)

NOTE:

Due to the ongoing import tariffs, a 11.25% surcharge will be applied to all orders, effective 9/4/2019 until further notice.

PRESSURES	304D	304L
	Dial Size 2-1/2"	Dial Size 2-1/2"
A = 30/0" hg VAC	9P304D-254A	9P304L-254A
CB = 30/0/15 PSI	9P304D-254CB	9P304L-254CB
CC = 30/0/30 PSI	9P304D-254CC	9P304L-254CC
CD = 30/0/60 PSI	9P304D-254CD	9P304L-254CD
CE = 30/0/100 PSI	9P304D-254CE	9P304L-254CE
CF = 30/0/150 PSI	9P304D-254CF	9P304L-254CF
CG = 30/0/200 PSI	9P304D-254CG	9P304L-254CG
CH = 30/0/300 PSI	9P304D-254CH	9P304L-254CH
B = 0/15 PSI	9P304D-254B	9P304L-254B
C = 0/30 PSI	9P304D-254C	9P304L-254C
D = 0/60 PSI	9P304D-254D	9P304L-254D
E = 0/100 PSI	9P304D-254E	9P304L-254E
F = 0/160 PSI	9P304D-254F	9P304L-254F
G = 0/200 PSI	9P304D-254G	9P304L-254G
H = 0/300 PSI	9P304D-254H	9P304L-254H
I = 0/400 PSI	9P304D-254I	9P304L-254I
J = 0/500 PSI	9P304D-254J	9P304L-254J
K = 0/600 PSI	9P304D-254K	9P304L-254K
L = 0/800 PSI	9P304D-254L	9P304L-254L
M = 0/1000 PSI	9P304D-254M	9P304L-254M

Pressure Gauges Special Application

PRICING CODE | **9P**

NOTE:
Due to the ongoing import tariffs, a 11.25% surcharge will be applied to all orders, effective 9/4/2019 until further notice.

TYPE GT - GAS TEST	COMPLETE ASSEMBLY
2" Gauge - Plated Hexagon Body 3/4" Fnpt - Airvalve W/Plastic Cap Stock Ranges: 15, 30, 60, 100 PSI 3/4", 1/2", 1" Female (Stock)	✓

TYPE HOSE - WATER TEST	WITHOUT MAX POINTER	WITH MAX POINTER
2-1/2" Gauge - Plastic Case - Brass Tube and Socket - Brass Hose Bib - Top Connection 0 - 300 PSI	✓	✓

* Maximum Pressure Indicator Available

**THIS PAGE IS
INTENTIONALLY
LEFT BLANK**

PTFE Thread Tape

PRICING CODE | 9T

FEATURES:

- Provides a highly resistant seal on pipe threads for all types of service.
- Permits easy disassembly after years.
- Meets Mil. Spec. T-27730A.
- Made of pure white "Teflon" (Non-Toxic)

APPLICATIONS:

- Suitable for use with solvents, chemicals, oxygen and on food lines.
- Pressures to 2000 PSI.

TEMPERATURE RANGE:

-450°F to +550°F

LOW DENSITY PTFE TAPE



PART#	SIZE
9T LD050X260	1/2" X 260"
9T LD050X520	1/2" X 520"
9T LD075X520	3/4" X 520"
9T LD100X520	1" X 520"

HIGH DENSITY PTFE TAPE



PART#	SIZE
9T HD050X520	1/2" X 520"

**THIS PAGE IS
INTENTIONALLY
LEFT BLANK**

Hose and Tubing Cutters



PRICING CODE 8J/2X

		PART #	DESCRIPTION
	Cutter	8J M50	<ul style="list-style-type: none"> - Always a straight cut. - Suitable for cutting up to 1/2" O.D. tubing easily. - Produces no cutting residue to contaminate pipe, tubing or hose. - Non-slip finger pads.
	Replacement Blade	8J M50/BLADE	
	Cutter	2X T10010	<p>A useful addition to your tool box featuring:</p> <ul style="list-style-type: none"> - Tempered Swedish Steel Blade (one included) - Metal Housing - PVC Coated Handles - Cutting Tension controlled by Spring Steel - Handle Lock
	Extra Blades (2 Per Pkg.)	2X TB10011	
	T100 Cutter	2X T100	<p>Kwikcut Benefits:</p> <ul style="list-style-type: none"> - Up to 8 times faster than sawing & deburring. - Produces no sawdust or cutting residue to contaminate pipe, tubing or hose. - Tough durable nylon handles. - Blade closes into handle for safe handling. - Replaceable steel blade. - T100 can cut up to 1-1/4" O.D. - SS200 can cut up to 1-7/8" O.D.
	T100 Blade	2X TB100	
	SS200 Cutter	2X SS200	
	SS200 Blade	2X SSB200	

**THIS PAGE IS
INTENTIONALLY
LEFT BLANK**

Greases

PRICING CODE 9X



	PART #	DESCRIPTION	SIZE / PACKAGING
<p>EP Bearing Grease™</p> 	9X30350	<p>Industrial Grade</p> <ul style="list-style-type: none"> • 0°F to 325°F (-18°C to 163°C) • Superior Rust & Corrosion Protection • Dropping Point - 390°F (199°C) • Lithium 12-Hydroxystearate Base • Color - Purple • Highly Adhesive to Metal • NLGI Grade 2 <p>EP BEARING GREASE is an all-purpose lithium grease containing extreme-pressure and boundary lubricants. The additive package enhances the shear stability, lubrication properties and high temperature characteristics of lithium-based grease, making EP BEARING GREASE a versatile, cost-efficient, multipurpose grease.</p> <p>EP BEARING GREASE is water resistant, highly tenacious, and has excellent resistance to the effects of salt spray, heat, water, oxidation, high loads and other adverse conditions common to industrial usage. It is a stable, high-temperature grease.</p> <p>Specially formulated for use on roller bearings, anti-friction bearings, journals, and is particularly useful where a single, multipurpose product is desirable.</p>	14 oz Cartridge
<p>ALCO-EP-73 Plus Grease™</p> 	9X37750	<p>Premium Multipurpose Grease</p> <ul style="list-style-type: none"> • -20°F to 450°F (-29°C to 232°C) • Superior Rust & Corrosion Protection • Dropping point - 500°F (260°C) • Polymer Additives for Extreme Water Resistance • Color - Red • Exceeds Military Spec MIL-G-18458B-SH <p>ALCO-EP-73 PLUS is a premium, state-of-the-art, multipurpose, aluminum complex grease containing a highly synergistic blend of rust and oxidation inhibitors plus extreme pressure and anti-wear additives for maximum performance characteristics.</p> <p>ALCO-EP-73 PLUS also contains polymer additives, further enhancing the inherent water resistance of an aluminum complex based grease. This multipurpose grease is extremely resistant to rust and corrosion and suited for use in high moisture areas. It's specially formulated and developed for subsea or other conditions where extreme water resistance is necessary. The highly developed additive package makes ALCO-EP-73 PLUS the premier, multipurpose grease for hostile environments.</p>	14 oz Cartridge

*Additional sizes and packaging available.

Continued on next page...

Greases

PRICING CODE 9X

	PART #	DESCRIPTION	SIZE / PACKAGING
<p>FMG Food Machinery Grease</p> 	<p>9X30150</p>	<ul style="list-style-type: none"> • 0°F (-18°C) to over 400°F (204°C) • NSF H1 Rated • Non-Pound Out Formula • Bacteriostatic Agent • Anti-wear Additives • Color – White <p>FMG is specifically designed for use in the food processing industry where it may have incidental food contact. FMG has been formulated to perform in a wide variety of operating conditions. It is extremely water resistant and will remain in place even after frequent wash downs.</p> <p>FMG's polymer additives provide adhesive/cohesive strength to protect against pound-off when shock loads are encountered. For slower speeds, higher loads or greater adhesion and water resistance. FMG is also available in an ISO 460 grade.</p> <p>FMG is recommended for the lubrication of roller, needle, ball, journal, and sliding bearings in the food processing and handling industry.</p>	<p>14 oz Cartridge</p>
<p>Arctic™ Extreme Low Temperature Grease</p> 	<p>9X35050</p>	<ul style="list-style-type: none"> • Extreme Cold Temperature Grease -65°F to 225°F (-54°C to 107°C) • Dropping Point of 285°F (141°C) • Contains No Solid Additives • Extremely Resistant to Salt Spray • All Temperature Formula Effective Winter or Summer • Water Resistant • Rust & Corrosion Resistant • Color - Amber <p>ARCTIC is particularly suitable for use in extreme cold environments such as cold rooms, cold storage lockers, ice plants, and on refrigeration or cold storage equipment. It will resist such environmental contact as humidity, ice, and road salts without hardening, washing off or deteriorating. ARCTIC is an excellent service grease that has passed the Shell Roll Test for 100 hours at 150°F (66°C), and the Federal Test Method Standard No. 791B, Method No. 3454.2 "Leakage Tendencies of Automotive Wheel Bearing Greases" and ASTM 1263. It also passes the application salt-spray resistance and rust tests required by the United States government for its severe environmental contact greases. ARCTIC may be used on automobiles and aircraft, in industrial applications, or anywhere lubricating properties of a moderate to severe nature are required over a wide range of temperatures.</p>	<p>14 oz Cartridge</p>

*Additional sizes and packaging available.

Continued on next page...

Greases



PRICING CODE 9X

	PART #	DESCRIPTION	SIZE / PACKAGING
<p>Silicone Compound DM™</p> 	<p>9X73560</p>	<p>Dielectric Grease</p> <ul style="list-style-type: none"> • NSF H1 Registered #132224 (DM-3), #132225 (DM-2) • Water Resistant • Nontoxic/Safe • Wide Temperature Range • Extremely Chemical Resistant • Translucent Paste • Highly Resistant to Oxidation & Shear Breakdown • Suitable for Valve Lubrication • Dielectric Strength - 500 volts/mil typical • Conforms to: MIL-S-8660C (DM-3), MIL-C-21567A (DM-2), NATO Code #S-736 • Standard NLGI 3 <p>SILICONE COMPOUND DM is a premium silicone compound for use in a wide variety of applications. Its low volatility, non-melting thickener and high dielectric strength make it the compound of choice for moisture proofing ignition systems, spark plug connections, electrical assemblies, cable and battery terminals and other similar applications. In the higher NLGI grades, SILICONE COMPOUND DM provides excellent lubrication and sealing properties for plug and gate valves, stuffing boxes, o-rings, vacuum and pressure systems. The low volatility and inert properties allow it to be used on a wide range of elastomers and plastics. It is not recommended for use on surfaces to be painted. Excellent for high temperature bearings, conveyor systems, and low-temp refrigeration systems.</p>	<p>5 oz Tube</p>

*Additional sizes and packaging available.

Anti-Seizes

PRICING CODE 9X

	PART #	DESCRIPTION	SIZE / PACKAGING
<p>KOPR-KOTE® Anti-Seize and Thread Lubricant</p> 	<p>9X10002</p>	<ul style="list-style-type: none"> • -65°F to 1800°F (-54°C to 982°C) • NSF H2 Registered • MIL PRF-907F • Raytheon-Spec M8656839 Type I • Load Rating -80,000 psi • Friction Coefficient (K-factor) - 0.15 • 10% Pure Metallic Copper Flake • No VOC • NSN #8030-01-239-8703 • Not Classified as a Marine Pollutant • DOT Approval CA2004080025 <p>KOPR-KOTE is a combination of copper flake, graphite and other extreme pressure additives, blended into a food grade grease base that helps properly distribute all the components on the surface of the fastener or the metal surface needing lubrication. This particle distribution is necessary to achieve the .15 K-Factor and aids in the break out process by reducing metal-to-metal contact that can cause friction, heat and damage to the threaded surface.</p>	<p>1/2 lbs Brushtop Can</p>
<p>550® Extreme Anti-Seize</p> 	<p>9X47102</p>	<p>Non-Metallic Petrochemical-Grade Anti-Seize and Thread Lubricant</p> <ul style="list-style-type: none"> • -65°F to 1200°F (-54°C to 648°C) • MIL PRF-907F • Friction Coefficient (K-Factor) – 0.15 - 0.17 • Blend of Molybdenum Disulfide & Special Oxidation Resistant Graphite • No VOC <p>550 EXTREME ALL-WEATHER offers the same performance and package of solid lubricants, such as 550 EXTREME but with a new and advanced synthetic grease base carrier. This grease offers exceptional brushability down to 40°F/40°C and carries a flash point of over 500°F/260°C. For an anti-seize compound to work effectively, it needs to be properly applied to the threads. Standard petroleum oils will harden significantly below 10°F/-12°C making this application difficult. 550 EXTREME ALL-WEATHER's base grease is a blend of synthetic fluids with pour points no higher than -50°F /-46°C, thickened with a calcium sulfonate complex to provide better rust and corrosion protection. This unique combination makes for an excellent product in low temperature environments but equally as good in high temperatures.</p>	<p>1/2 lbs Brushtop Can</p>

*Additional sizes and packaging available.

Continued on next page...

Anti-Seizes

PRICING CODE

9X

	PART #	DESCRIPTION	SIZE / PACKAGING
<p>White Knight™ Anti-Seize</p> 	<p>9X16402</p>	<p>Food Grade Anti-Seize Thread Lubricant</p> <ul style="list-style-type: none"> • -65°F to 1800°F (-54°C to 982°C) • Color - White • NSF H1 Registered • FDA REG: CFR 21 part 178.3570 • MIL-PRF 907E • Load Rating - 80,000 psi • No Metallic Content <p>WHITE KNIGHT is a non-drying, synthetic fortified thread lubricant. It protects and lubricates metal parts and threaded fasteners from rust and corrosion up to 1800°F (982°C). WHITE KNIGHT incorporates the bacterial fungi static agent propyl paraben which is widely used in the food lubricant industry. Ideal for use on threaded fasteners for food processing equipment, threaded bottle filling heads, and baking oven chain drives. WHITE KNIGHT is also effective on stainless steel, aluminum, iron galvanized fittings and plastic/nylon components.</p>	<p>1/2 lbs Brushtop Can</p>

*Additional sizes and packaging available.

Coatings & Penetrants

PRICING CODE

9X

	PART #	DESCRIPTION	SIZE / PACKAGING
<p>769[®] Lubricant</p> 	<p>9X37341</p>	<p>Nonflammable Penetrant/ Lubricant/Moisture Displacer/ Protectant</p> <ul style="list-style-type: none"> • NSF H2 Rated • 35KV Dielectric Strength • Nonflammable • Nonevaporating • Contains No Silicones • NSN #'s – 9150- 00-261-789, 8030-99-923-1633, 8030-00- 181-7603 • MIL-C-81309 Type II & III, Class II, CO2 Grade (Aerosol) • MIL-C-81309 • Type II & III, Class I (Bulk) • MIL-C-16173E Grade 3 • MIL-C-23411A, VV-P-216B <p>769 LUBRICANT is the leading lubricating, penetrating, moisture displacing, and corrosion preventative coating on the market. Unequaled where salt water, salt spray or other harsh environments are present. 769 LUBRICANT gives total performance while being environmentally safe, easy to use and nonflammable.</p> <p>Lubricates: Contains ashless, extreme pressure additives and highly refined lubricating oils that provide superior lubricating protection and anti-wear properties.</p> <p>Penetrates: Rusted and frozen metal parts – studs, nuts, screws, pins, linkages are easily loosened by means of superior “creepability.”</p> <p>Removes Moisture: Moisture is lifted and displaced rather than trapped. Pores and crevices of surfaces are freed from moisture and are coated with a thin, non-greasy film that prevents additional moisture from clinging or entering.</p> <p>Prevents Rust & Corrosion: Thin film adheres to metallic surfaces, providing positive, temporary protection against the formation of rust and corrosion, including electrolytic and galvanic corrosion common in salt environments.</p>	<p>12 oz Aerosol</p>



*Additional sizes and packaging available.

Continued on next page...

Coatings & Penetrants

PRICING CODE

9X



	PART #	DESCRIPTION	SIZE / PACKAGING
<p>Z-Plate™ Galvanizing Compound</p> 	<p>9X60541</p>	<p>Zinc-Rich Galvanizing Compound</p> <ul style="list-style-type: none"> • Fast Evaporating • Color - Grey • Cone Spray Water Displacing • Dry Film • Long-Term Coating • 95% Pure Metallic Zinc • Rust & Corrosion Inhibited <p>Z-PLATE Prevents: Rust and corrosion with galvanic action equal to hot-dip galvanizing. 95% pure zinc compound which forms a tough, durable and flexible coating.</p> <p>Z-PLATE Repairs: Galvanized surfaces damaged by cutting or welding. Primer for surfaces to be painted. Protects against salt water. It requires little surface preparation. Z-PLATE is excellent for cosmetic repairs to welded joints, guard rails, bridges, fencing, storage tanks, pipe lines, TV towers, metal buildings, heavy equipment, heat ducts, marine and offshore equipment.</p>	<p>14.75 oz Aerosol</p>
<p>Rust-Guard Rust Inhibitor</p> 	<p>9X13241</p>	<ul style="list-style-type: none"> • Contains No Fluorocarbons • Indoor & Outdoor Formula • MIL-PRF-16173E <p>RUST-GUARD is a specialized water displacing formula which dries to a uniform, thin waxy film to effectively seal out moisture and corrosion. RUST-GUARD provides long-term protection on all metal and alloy surfaces, even under harsh environmental conditions such as water, high humidity or salt spray. RUST-GUARD's bulk formula typically provides six months outdoor and one year indoor protection against rust and corrosion. RUST-GUARD may be used indoors or outdoors as a protective coating on raw materials, machined parts, tools, pipe, fittings, valves, etc., while they are being stored or in transit. RUST-GUARD will not crack or flake off, it penetrates fully into even the smallest crevices to displace moisture and prevent rust and corrosion. RUST-GUARD is green in color to provide a visual check of product application and is easily and safely removed by use of a safety solvent such as CLEAN-UPTM.</p>	<p>11 oz Aerosol</p>

*Additional sizes and packaging available.

Cleaners & Degreasers

PRICING CODE

9X

	PART #	DESCRIPTION	SIZE / PACKAGING
<p>Clean-Up Plus™</p> 	9Z72542	<p>Citrus Degreaser</p> <ul style="list-style-type: none"> • NSF C1 Rated • Replaces 1:1:1 Trichloroethane • Nonflammable Propellant • Natural Organic Formula • Ozone Friendly • Biodegradable • 29KV Dielectric Strength <p>CLEAN-UP PLUS is a high-performance blend of safe, organic solvents that quickly dissolves and rinses away dirt, grease, grime, oil, tar, and wax, while being both environmentally safe and ozone friendly. It works immediately on contact, breaking down and dissolving even the most stubborn contaminants without the use of fluorinated, chlorinated or SARA listed ingredients. CLEAN-UP PLUS slowly evaporates while cleaning, leaving a residue free surface. This degreaser is safe on all metals and most plastics.</p>	15 oz Aerosol
<p>Easy-Clean® Liquid</p> 	9X30033	<p>Alkaline-Based Concentrate</p> <ul style="list-style-type: none"> • Biodegradable • Nontoxic • Nonflammable • Noncombustible • Nonfuming • Water Soluble <p>EASY-CLEAN LIQUID is an alkaline-based cleaner/degreaser that uniquely combines cleaning agents with newly developed emulsifying technology to provide a product that can effectively remove carbon, grease, oil and other organic deposits while being both safe and ozone friendly. It contains no 1:1:1 Trichloroethane, Fluorocarbons or SARA Title III, Section 313, Part 372 listed ingredients and contains no acids, chlorides, phosphates or TTO's (Total Toxic Organic Compounds).</p> <p>EASY-CLEAN LIQUID is the most effective cleaner/degreaser for heavy-duty industrial services on the market and can be used for parts degreasing, pressure washing, steam cleaning, ultrasound cleaning, or simply by brushing or spraying and then rinsing with water or wiping clean. For best results, combine a 5-gal. pail of EASY-CLEAN LIQUID with water in a 55-gal. drum.</p>	8 lbs Jug

*Additional sizes and packaging available.

Thread Sealants & Specialty Products

PRICING CODE 9X

PART #	DESCRIPTION	SIZE / PACKAGING
--------	-------------	------------------

Thread Sealants

<p>V-2® Thread Sealant</p> 	<p>9X35502</p>	<p>Multipurpose Pipe Thread Sealant with PTFE</p> <ul style="list-style-type: none"> • Rated: 70°F to 500°F (-57°C to 260°C) • NSF 61 Certified • #21265 • Uniform Plumbing Code: IAPMO #1282 • Biodegradable • MIL-TT-S-1732 • No VOC • Seals to 10,000 psi • Friction Factor - 0.07 • Brushable to 0°F • Contains PTFE • Safe to use on PVC & Fiberglass Fittings • No Odor <p>V-2 is a combination of vegetable oil, PTFE and inert fillers that are environmentally safe, nontoxic for use in potable water applications, on NPT and standard pipe fittings. It's a soft setting product, so you can remove the fitting without damage to the threads. This formulation also has rust and corrosion inhibitors built in so the connection/fitting will not rust or corrode. V-2 also has a bacteria/fungistat which is a food grade additive that will eliminate bacterial culturing.</p>	<p>1/2 Pint Brushtop Can</p>
---	----------------	--	----------------------------------

Specialty Products

<p>Food Grade Silicone Food Grade Lubricant</p> 	<p>9X50641</p>	<ul style="list-style-type: none"> • NSF H1 Registered • FDA Regulation CFR-21, Part 178.3570 • Nontoxic • Safe on plastics • Nonstaining • Colorless/ Odorless • Excellent Release Agent • Authorized for use by Agriculture Canada • Contains No 1:1:1 Trichloroethane, Freon <p>FOOD GRADE SILICONE is an excellent lubricant for use on processing equipment in all types of food and food related industries where incidental food contact may occur. FOOD GRADE SILICONE stops sticking, squeaking and binding of moving parts. It has an excellent release agent. FOOD GRADE SILICONE will not gum or form unwanted residues, instead it leaves a clear film that is moisture resistant, long-wearing, odorless, colorless and nontoxic.</p>	<p>12 oz Aerosol</p>
---	----------------	--	----------------------

*Additional sizes and packaging available.

**THIS PAGE IS
INTENTIONALLY
LEFT BLANK**

PORTABLE EXCHANGE & DI

DESCRIPTION	PAGE
Culligan (Slip Style) Products	H1
Hose Connectors	H11
Rayne (Yoke Style) Products	H21
Park Style Fittings	H29
DI Tank Heads & Accessories	H35
PE & DI Tanks	H45
Bypass Valves	H57
Carts & Accessories	H59
Eductors	H65
Flow Controls	H67
Regeneration Funnels & Parts	H71
Miscellaneous	H73

**THIS PAGE IS
INTENTIONALLY
LEFT BLANK**

PORTABLE EXCHANGE & DI



AM Products and Services is now a part of Specialty Sales!

AM Products and Services was founded in 1994 by Don Zelinski to provide the Portable Exchange and DI industry with hard-to-find tanks, fittings, and other components. Don brought an extraordinary commitment to product innovation and customer service to his business and built long-term customer relationships from his facility in Manitowoc, WI. Over 3 decades, AM Products and Services became renowned in the industry for their unwavering dedication to quality, innovation, and customer service. Don consistently strived to deliver cutting-edge solutions that exceeded industry standards, earning the trust and loyalty of our esteemed customers.

In 2022, AM Products and Services merged with Specialty Sales, a family-owned business founded in 1970. The two companies had been working together for the majority of AM Products' existence, and Don experienced a shared commitment to customer service, ensuring his customers would continue to be treated to the level of service they were used to.

The merging of the two family-owned businesses has opened new horizons, enabling us to further enhance our offerings and serve customers even better. We continue to supply the Portable Exchange and DI industry with difficult-to-source components, and now provide the full Specialty Sales catalog of water treatment products as well.

We look forward to continuing to provide The Components You Need, The Knowledge You Trust, and The Service You Deserve as combined companies.





**THIS PAGE IS
INTENTIONALLY
LEFT BLANK**

Slip Style Culligan Fittings



FEATURES:

- Fittings for use in Culligan slip style PE and PEDI systems.
- Machined from solid bars of lead-free brass, 304 stainless steel, or 316 stainless steel.
- Lead free brass is recommended for portable exchange.
- 304 Stainless Steel is recommended for use in DI water systems.
- 316 Stainless Steel is recommended in the presence of regeneration chemicals.

INLET COUPLINGS (MALE SLIP X NPT)

	PART #	DESCRIPTION	MATERIAL	NOTES
	222000LF	3/4" NPT Male Coupling - Inlet	LF Brass	Inlet couplings are designed to accept the flange of Culligan Style drop in inlet distributors (Page H15). Does not include 220110 and 220110SS. Male threads are cut deeper to prevent "Galling".
	222002-304	3/4" NPT Male Coupling - Inlet	304 SS	
	222002-316	3/4" NPT Male Coupling - Inlet	316 SS	

OUTLET COUPLINGS (MALE SLIP X NPT)

	PART #	DESCRIPTION	MATERIAL	NOTES
	222003LF	3/4" NPT Male Coupling - Outlet	LF Brass	Outlet couplings are designed with an internal thread to accept screw in outlet manifold (Page H15). Male threads are cut deeper to prevent "Galling".
	222001-304	3/4" NPT Male Coupling - Outlet	304 SS	
	222001-316	3/4" NPT Male Coupling - Outlet	316 SS	



Continued on next page...

Slip Style Culligan Fittings *continued*

COUPLINGS FOR PLASTIC THREADS (MALE SLIP X NPT)

	PART #	DESCRIPTION	MATERIAL	NOTES
	222002-P-304	3/4" NPT Male Coupling (for plastic threads)	304 SS	Couplings designed with true 3/4" pipe thread for plastic mating threads. Couplings do not have internal threads. Primarily used on plastic heads (Starting on page H35)
	222002-P316	3/4" NPT Male Coupling (for plastic threads)	316 SS	
	222002-P-304-1	1" NPT Male Coupling (for plastic threads)	304 SS	



HOSE FITTING (FEMALE SLIP X HB)

	PART #	DESCRIPTION	MATERIAL	NOTES
 	222040LF	Hose Fitting	LF Brass	Typically used on hose assemblies (Pages H5 and H6)
	222041-316	Hose Fitting	316 SS	
	222041-304	Hose Fitting	304 SS	

Continued on next page...

Slip Style Culligan Fittings *continued*

ADAPTERS (FEMALE SLIP X NPT)

	PART #	DESCRIPTION	MATERIAL	NOTES
	222080LF	Adapter x 1/2" NPT	LF Brass	Female slip adapter x male pipe thread
	222060LF	Adapter x 3/4" NPT	LF Brass	
	222081-304	Adapter x 1/2" NPT	304 SS	
	222082-304	Adapter x 3/4" NPT	304 SS	
	222081-316	Adapter x 1/2" NPT	316 SS	
	222082-316	Adapter x 3/4" NPT	316 SS	

Continued on next page...





Slip Style Culligan Fittings *continued*

BARBED FITTINGS

	PART #	DESCRIPTION	MATERIAL	NOTES
	222009LF	1/2" NPT x 3/4" Barb	LF Brass	LF brass and stainless steel fittings are machined from solid blocks of material resulting in a higher end fitting. PVC fittings are Schedule 80.
	222010LF	3/4" NPT x 3/4" Barb	LF Brass	
	222011-316	3/4" NPT x 3/4" Barb	316 SS	
	222012-316	1/2" NPT x 3/4" Barb	316 SS	
	8X1436-007	3/4" NPT x 3/4" Barb	PVC	
	8X1436-074	1/2" NPT x 3/4" Barb	PVC	
	8X1436-010	1" NPT x 1" Barb	PVC	
	222015	Female Garden Hose x 3/4" Barb	LF Brass	

LF brass and stainless steel fittings are machined from solid blocks of material resulting in a higher end fitting. PVC fittings are Schedule 80.

Culligan (Slip Style) O-Rings and Gaskets



	PART #	DESCRIPTION	NOTES
	221000	Gasket-Silicone Treated Black EP 0.53 x 0.923 x 0.208	Standard gaskets for use with female slip style adapters (EX: 220040LF)
	221010	Gasket White Striped SBR 0.52 x 0.92 x 0.227	Thicker for use with worn fittings
	221300	Gasket-Backwash 0.625 x 1.0 x 0.187	Primarily used in regeneration plants in conical adapter (230430)
	221300-OR	O-Ring Backwash	Primarily used in regeneration plants
	221002	Gasket - comparable to Culligan molded gasket . 555 x 0.935 x 0.197	Harder material and slightly thinner than 221000
	221005	Fiber Spacer Washer	Shim

Culligan (Slip Style) Inlet Distributors and Manifolds

FEATURES:

- Inlet distributors for use with Culligan (Slip Style) fittings like 222000LF

INLET DISTRIBUTORS

	PART #	SIZE	DESCRIPTION	NOTES
	220102	2.875"	Inlet Distributor - PVC	Distributors created with flange allowing dist. to be dropped into Culligan style slip couplings like 222000LF. PVC rated to 130°F
	220105	7"	Inlet Distributor - PVC	
	220107	7"	Inlet Distributor - CPVC	Distributors created with flange allowing dist. to be dropped into Culligan style slip couplings like 222000LF. CPVC is rated for 180°F
220109	2.875"	Inlet Distributor - CPVC		
	220106	2.875"	Inlet Distributor - Wide Slot PVC	Larger slot sizes for use in extremely hard water to stop slots from becoming blocked with hardness. PVC rated to 130°F.
	220110	-	Inlet Distributor - 14" Tank PVC	-
	220110-SS	-	Inlet Distributor 14" Tank Stainless	-

Culligan (Slip Style) Outlet Distributors and Manifolds

FEATURES:

- For use with Culligan (Slip Style) outlet fittings like 222003LF

OUTLET DISTRIBUTORS (STRAIGHT STYLE)



PART #	SIZE	DESCRIPTION	NOTES
220311	42"	Outlet Distributor - PVC (Straight Style)	Outlet Distributors are designed to screw into Outlet coupling (EX: 222003LF)
220312	42"	Outlet Distributor - Hot Water CPVC (Straight Style)	
220300LF	42"	Male Coupling #222003LF and 42" Distributor #220311 Assembly	-

OUTLET DISTRIBUTORS (HOCKEY STICK STYLE)



PART #	SIZE	DESCRIPTION	NOTES
220103	19"	Outlet Distributor D-50 - CPVC (Hockey Stick Style)	Outlet Distributors are designed to screw into Outlet coupling (EX: 222003LF)
220313	42"	Outlet Distributor - PVC (Hockey Stick Style)	
220314	42"	Outlet Distributor - Hot water CPVC (Hockey Stick Style)	

OUTLET DISTRIBUTORS FOR 14" TANKS

PART #	SIZE	DESCRIPTION
220315	14"	Outlet Distributor - 14" Tank PVC
220315-SS	14"	Outlet Distributor - 14" Tank-Stainless

Misc. Slip Style



MALE COUPLING WRENCH

	PART #	DESCRIPTION
	250030	Used for assembly and disassembly of male couplings such as #222003LF

YOKE JAM NUT - BRASS

	PART #	DESCRIPTION
	210091	Used to reduce vibration from loosening a bolted joint

OUTLET SAFETY SCREENS

	PART #	DESCRIPTION	NOTES
	220104	Outlet Safety Screen - PVC	Provides much more surface area so does not clog as fast and does not need to be thrown away when gasket wears out. Inserts into outlet distributor and rests inside outlet fitting for easy removal for cleaning.
	220108	Outlet Safety Screen - Wire 40 Mesh 304ss (220104 and 220108 replace screened gasket)	-
	220111	Outlet Safety Screen for 2.5" Plastic Heads - PVC	-
	220112	Outlet Safety Screen for 4.5" Plastic Heads - PVC	-

Continued on next page...

Misc. Slip Style *continued*

PORTABLE EXCHANGE TANK BAG/BLADDER

PART #	DESCRIPTION	NOTES
240000	PE Tank Bag/Bladder Kit (contains 1 bag, 1 gasket, 1 spacer)	For used for old hull tanks
240001	PE Tank Bag/Bladder Gasket	-
240002	PE Tank Bag/Bladder Spacer	-

RESIN TEST TUBE

PART #	DESCRIPTION	NOTES
500502	Clear Resin Testing Tube 0.54" OD x 48"	-

LOK RINGS FOR HOSE ASSEMBLIES

PART #	DESCRIPTION	NOTES
210090-BLACK	Lok Ring - Black	Used with Culligan style hose assemblies
210090-RED	Lok Ring - Red	-



RUBBER CAP

PART #	DESCRIPTION	NOTES
210100	EPDM Rubber cap for use with Culligan Style Tanks (3/4" inlet/outlet)	Used on male couplings such as #222003LF



**THIS PAGE IS
INTENTIONALLY
LEFT BLANK**

Hose Connectors



FEATURES:

- Hose connectors are used to connect the plumbing/ bypass to the stainless steel tank
- Female Slip x MPT
- Gray hose is style 5000 (Page A1)
- Blue is reinforced PVC and rated for potable water (Next page)
- Black hose is rubber and NOT rated for potable water
- ***We offer a potable water rated rubber hose that is more suitable for intense heat situations, please call for availability and pricing.***
- Lead-free brass is recommended for portable exchange
- 304 Stainless steel is recommended for use in DI water systems
- 316 Stainless Steel is recommended in the presence of regeneration chemicals
- All hoses can be ordered in custom lengths, but no shorter than 4.5"

PART #	LENGTH	FITTING MATERIAL	HOSE TYPE	DESCRIPTION
210000-LF-GRAY	4.5"	LF Brass	Gray	4.5" Hose Connector - LF Brass - 3/4" MPT x Female Slip - 3/4" Gray Hose
210000-LF-BLACK	4.5"	LF Brass	Black	4.5" Hose Connector - LF Brass - 3/4" MPT x Female Slip - 3/4" Black Hose
210000-LF-BLUE	4.5"	LF Brass	Blue	4.5" Hose Connector - LF Brass - 3/4" MPT x Female Slip - 3/4" Blue Hose
210015-LF-GRAY	6.25"	LF Brass	Gray	6.25" Hose Connector - LF Brass - 3/4" MPT x Female Slip - 3/4" Gray Hose
210015-LF-BLACK	6.25"	LF Brass	Black	6.25" Hose Connector - LF Brass - 3/4" MPT x Female Slip - 3/4" Black Hose
210015-LF-BLUE	6.25"	LF Brass	Blue	6.25" Hose Connector - LF Brass - 3/4" MPT x Female Slip - 3/4" Blue Hose
210001-LF-GRAY	8.5"	LF Brass	Gray	8.5" Hose Connector - LF Brass - 3/4" MPT x Female Slip - 3/4" Gray Hose
210001-LF-BLACK	8.5"	LF Brass	Black	8.5" Hose Connector - LF Brass - 3/4" MPT x Female Slip - 3/4" Black Hose

Continued on next page...

Hose Connectors *continued*

PART #	LENGTH	FITTING MATERIAL	HOSE TYPE	DESCRIPTION
210001-LF-BLUE	8.5"	LF Brass	Blue	8.5" Hose Connector - LF Brass - 3/4" MPT x Female Slip - 3/4" Blue Hose
210002-304SS-GRAY	8.5"	304 SS	Gray	8.5" Hose Connector - 304 SS - 1/2" MPT x Female Slip - 3/4" Gray Hose
210002-304SS-BLUE	8.5"	304 SS	Blue	8.5" Hose Connector - 304 SS - 1/2" MPT x Female Slip - 3/4" Blue Hose
210002-316SS-GRAY	8.5"	316 SS	Gray	8.5" Hose Connector - 316 SS - 1/2" MPT x Female Slip - 3/4" Gray Hose
210002-316SS-BLUE	8.5"	316 SS	Blue	8.5" Hose Connector - 316 SS - 1/2" MPT x Female Slip - 3/4" Blue Hose
210003-304SS-GRAY	8.5"	304 SS	Gray	8.5" Hose Connector - 304 SS - 3/4" MPT x Female Slip - 3/4" Gray Hose
210003-304SS-BLUE	8.5"	304 SS	Blue	8.5" Hose Connector - 304 SS - 3/4" MPT x Female Slip - 3/4" Blue Hose
210003-316SS-GRAY	8.5"	316 SS	Gray	8.5" Hose Connector - 316 SS - 3/4" MPT x Female Slip - 3/4" Gray Hose
210003-316SS-BLUE	8.5"	316 SS	Blue	8.5" Hose Connector - 316 SS - 3/4" MPT x Female Slip - 3/4" Blue Hose
210004-304SS-GRAY	8.5"	304 SS	Gray	8.5" Hose Connector - PVC 1/2" MPT x 304 SS Female Slip - 3/4" Gray Hose
210004-304SS-BLUE	8.5"	304 SS	Blue	8.5" Hose Connector - PVC 1/2" MPT x 304 SS Female Slip - 3/4" Blue Hose

Continued on next page...



Hose Connectors *continued*

PART #	LENGTH	FITTING MATERIAL	HOSE TYPE	DESCRIPTION
210005-304SS-GRAY	8.5"	304 SS	Gray	8.5" Hose Connector - PVC 3/4" MPT x 304 SS Female Slip - 3/4" Gray Hose
210005-304SS-BLUE	8.5"	304 SS	Blue	8.5" Hose Connector - PVC 3/4" MPT x 304 SS Female Slip - 3/4" Blue Hose
210013-LF-GRAY	18"	LF Brass	Gray	18" Hose Connector - LF Brass - 3/4" MPT x Female Slip - 3/4" Gray Hose
210013-LF-BLACK	18"	LF Brass	Black	18" Hose Connector - LF Brass - 3/4" MPT x Female Slip - 3/4" Black Hose
210013-LF-BLUE	18"	LF Brass	Blue	18" Hose Connector - LF Brass - 3/4" MPT x Female Slip - 3/4" Blue Hose
210014-304SS-GRAY	18"	304 SS	Gray	18" Hose Connector - 304 SS - 3/4" MPT x Female Slip - 3/4" Gray Hose
210014-304SS-BLUE	18"	304 SS	Gray	18" Hose Connector - 304 SS - 3/4" MPT x Female Slip - 3/4" Blue Hose
210014-316SS-GRAY	18"	316 SS	Gray	18" Hose Connector - 316 SS - 3/4" MPT x Female Slip - 3/4" Gray Hose
210008-LF-GRAY	24"	LF Brass	Gray	24" Hose Connector - LF Brass - 3/4" MPT x Female Slip - 3/4" Gray Hose
210008-LF-BLACK	24"	LF Brass	Black	24" Hose Connector - LF Brass - 3/4" MPT x Female Slip - 3/4" Black Hose

Continued on next page...

Hose Connectors *continued*

PART #	LENGTH	FITTING MATERIAL	HOSE TYPE	DESCRIPTION
210008-LF-BLUE	24"	LF Brass	Blue	24" Hose Connector - LF Brass - 3/4" MPT x Female Slip - 3/4" Blue Hose
210009-304SS-GRAY	24"	304 SS	Gray	24" Hose Connector - 304 SS - 1/2" MPT x Female Slip - 3/4" Gray Hose
210009-304SS-BLUE	24"	304 SS	Blue	24" Hose Connector - 304 SS - 1/2" MPT x Female Slip - 3/4" Blue Hose
210009-316SS-BLUE	24"	316 SS	Blue	24" Hose Connector - 316 SS - 1/2" MPT x Female Slip - 3/4" Blue Hose
210010-304SS-GRAY	24"	304 SS	Gray	24" Hose Connector - 304 SS - 3/4" MPT x Female Slip - 3/4" Gray Hose
210010-304SS-BLUE	24"	304 SS	Blue	24" Hose Connector - 304 SS - 3/4" MPT x Female Slip - 3/4" Blue Hose
210011-304SS-GRAY	24"	304 SS	Gray	24" Hose Connector - PVC 1/2" MPT x 304 SS Female Slip - 3/4" Gray Hose
210011-304SS-BLUE	24"	304 SS	Blue	24" Hose Connector - PVC 1/2" MPT x 304 SS Female Slip - 3/4" Blue Hose
210012-304SS-GRAY	24"	304 SS	Gray	24" Hose Connector - PVC 3/4" MPT x 304 SS Female Slip - 3/4" Gray Hose
210012-304SS-BLUE	24"	304 SS	Blue	24" Hose Connector - PVC 3/4" MPT x 304 SS Female Slip - 3/4" Blue Hose

Jumper Hoses

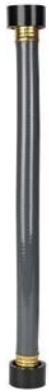

FEATURES:

- Jumper hoses are used to connect a tank to another tank in a series
- Female Slip x Female Slip
- Gray hose is style 5000 (Page H17)
- Blue is reinforced PVC and rated for potable water (Next page)
- Black hose is rubber and NOT rated for potable water
- We offer a potable water rated rubber hose that is more suitable for intense heat situations, please call for availability

INLET COUPLINGS (MALE SLIP X MPT)

PART #	LENGTH	FITTING MATERIAL	HOSE TYPE	DESCRIPTION
210006-304SS-GRAY	18"	304 SS	Gray	18" Jumper Hose - with 304 SS Lok Rings - DI Gray Hose
210006-304SS-BLUE	18"	304 SS	Blue	18" Jumper Hose - with 304 SS Lok Rings - DI Blue Hose
210006-316SS-GRAY	18"	316 SS	Gray	18" Jumper Hose - with 316 SS Lok Rings - DI Gray Hose
210006-316SS-BLUE	18"	316 SS	Blue	18" Jumper Hose - with 316 SS Lok Rings - DI Blue Hose
210017-304SS-GRAY	24"	304 SS	Gray	24" Jumper Hose - with 304 SS Lok Rings - DI Gray Hose

Continued on next page...



Jumper Hoses *continued*

PART #	LENGTH	FITTING MATERIAL	HOSE TYPE	DESCRIPTION
210017-304SS-BLUE	24"	304 SS	Blue	24" Jumper Hose - with 304 SS Lok Rings - DI Blue Hose
210017-316SS-GRAY	24"	316 SS	Gray	24" Jumper Hose - with 316 SS Lok Rings - DI Gray Hose
210017-316SS-BLUE	24"	316 SS	Blue	24" Jumper Hose - with 316 SS Lok Rings - DI Blue Hose
210007-LF-GRAY	18"	LF Brass	Gray	18" Jumper Hose - with LF Brass Lok Rings - Gray Hose
210007-LF-BLACK	18"	LF Brass	Black	18" Jumper Hose - with LF Brass Lok Rings - Black Hose
210007-LF-BLUE	18"	LF Brass	Blue	18" Jumper Hose - with LF Brass Lok Rings - Blue Hose
210016-LF-BLUE	24"	LF Brass	Blue	24" Jumper Hose - with LF Brass Lok Rings - Blue Hose
210016-LF-GRAY	24"	LF Brass	Gray	24" Jumper Hose - with LF Brass Lok Rings - Gray Hose
210016-LF-BLACK	24"	LF Brass	Black	24" Jumper Hose - with LF Brass Lok Rings - Black Hose

Style 5000 - NSF-61 Certified Grey Pureflex Water Hose



FEATURES:

- Compounds used made from materials on the FDA approved list
- Clear Pureflex Tube with Dark Grey Pureflex cover
- Lightweight, Non-Marking and Flexible
- UV Resistant
- NSF Certified under Standard NSF-51 and NSF-61
- 4:1 Tested Safety Factor on Burst PSI

APPLICATIONS:

Water and Beverage Transfer Lines

TEMPERATURE RANGE:

+25°F to +150°F

BRANDING:

SPECIALTY SALES STYLE 5000 (DATE CODE) CANADA

NOTE:

Cut lengths available - 15% surcharge.

PART#	OLD PART#	I.D.	O.D.	COLOR(S)	MATERIAL	WORKING PRESURE	MAX TEMP.	LENGTH	NOTES
2H5000/050-BULK	500499	1/2"	3/4"	Gray	Reinforced PVC	200	150°F	BULK	NSF-61 Certified
2H5000/050	500499-300	1/2"	3/4"	Gray	Reinforced PVC	200	150°F	300'	
2H5000/075-BULK	500531	3/4"	1.03"	Gray	Reinforced PVC	150	150°F	BULK	
2H5000/075-100	500531-100	3/4"	1.03"	Gray	Reinforced PVC	150	150°F	100'	
2H5000/075	500531-300	3/4"	1.03"	Gray	Reinforced PVC	150	150°F	300'	
2H5000/100-BULK	500533	1"	1.29"	Gray	Reinforced PVC	125	150°F	BULK	
2H5000/100-100	500533-100	1"	1.29"	Gray	Reinforced PVC	125	150°F	100'	
2H5000/100	500533-200	1"	1.29"	Gray	Reinforced PVC	125	150°F	200'	

Continued on next page...

500532 - High Purity PVC Hose

FEATURES:

- NSF 61 certified materials
- White inner tube and blue cover reduce tendency for algae growth in warm, sunny environments



PART#	I.D.	O.D.	COLOR(S)	MATERIAL	WORKING PRESURE	MAX TEMP.	LENGTH	NOTES
500532	3/4"	1.125"	Blue	Reinforced PVC	250	150°F	BULK	FDA and NSF Compliant Materials
500532-100	3/4"	1.125"	Blue	Reinforced PVC	250	150°F	100'	
500532-500	3/4"	1.125"	Blue	Reinforced PVC	250	150°F	500'	

500530 - Black Rubber Hose

FEATURES:

- Economical general service hose
- NOT rated for potable water applications
- Tube and cover are EPDM/SBR. Reinforcement is a two-spiral polyester yarn



PART#	I.D.	O.D.	COLOR(S)	MATERIAL	WORKING PRESURE	MAX TEMP.	LENGTH	NOTES
500530	3/4"	1.12"	Black	Rubber	200	190°F	BULK	NOT rated for potable water
500530-100	3/4"	1.12"	Black	Rubber	200	190°F	100'	
500530-500	3/4"	1.12"	Black	Rubber	200	190°F	500'	

500530-BU-R

FEATURES:

- Rubber hose rated for potable water use
- Will withstand high heat temperature while retaining drinking water certifications
- White FDA neoprene rubber with blue EPDM cover



PART#	I.D.	O.D.	COLOR(S)	MATERIAL	WORKING PRESURE	MAX TEMP.	LENGTH	NOTES
500530-BU-R	3/4"	1.24"	Blue	FDA Neoprene Rubber	250	180°F	BULK	Rated for use with potable water. Recommended for high heat applications.
500530-BU-R	3/4"	1.24"	Blue	FDA Neoprene Rubber	250	180°F	100'	

Style 05R - Industrial Grade Clear PVC Drain Line

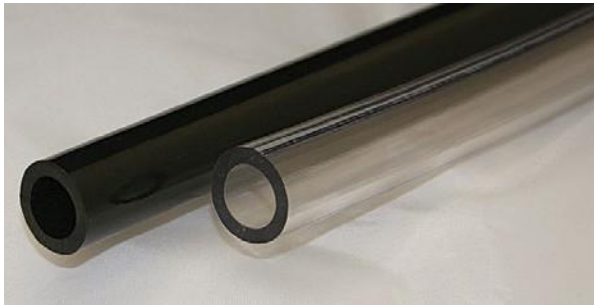

FEATURES:

- High Quality Industrial Grade Compounds
- Durometer Range Between 65 and 80
- Does Not Normally Meet FDA Standards

APPLICATIONS:

- Drain Lines
- Sight Gauges
- Transfer Lines
- Light Vacuum Lines

TEMPERATURE RANGE:

- +25°F to +150°F

NOTE:

- More tubing sizes and options available in section B

PART #	I.D.	O.D.	COLOR(S)	MATERIAL	LENGTH
2T 05R-0609	3/8"	9/16"	Clear/Black	PVC	100'
2T 05R-0609-250	3/8"	9/16"	Clear/Black	PVC	250'
2T 05R-1014	5/8"	7/8"	Clear/Black	PVC	100'

Style 20 – Linear Low Density Polyethylene (LLDPE) Tubing



FEATURES:

- Made From Non-Toxic Ingredients Conforming to FDA Standards
- Superior Crack Resistance
- Higher Working Pressure than Conventional Low Density Polyethylene
- Flexible, Lightweight and Durable
- Odorless and Tasteless
- Good Dielectric Properties
- Better Resistance to Stress Cracking than Low Density Polyethylene
- Chemically Inert

APPLICATIONS:

- Air, Water, and Chemical Transfer
- Transportation of Gases, Vapors, and Moisture

TEMPERATURE RANGE:

-50°F to +140°F

PART #	O.D.	I.D.	COLOR(S)	MATERIAL	LENGTH
2T 20-0604	3/8"	1/4"	Natural/Black	Polyethylene	100'
2T 20-0604-500	3/8"	1/4"	Natural/Black	Polyethylene	500'
2T 20-1008	5/8"	1/2"	Natural/Black	Polyethylene	100'



LLDPE tubing available in wide range of sizes and colors not listed above. Please call for more information.

Rayne (Yoke) Style Fittings

FEATURES:

- Fittings for use with Rayne (Yoke) Style portable exchange and DI equipment systems.
- Machined from solid bars of lead free brass, 304 stainless steel, or 316 stainless steel. This leads to a higher quality fitting compared to forged
- Lead free brass is recommended for portable exchange

CONNECTORS

	PART #	YOKE SIZE	DESCRIPTION	NOTES
	330063-LF	3/4"	Connector Body	
	330066-LF	1"	Connector Body	
	330062-LF	3/4"	Connector Assembly	Connector assemblies come with the 1 connector body (3/4" = 330063-LF OR 1" = 330066-LF, 1 yoke strap (330070), and 2 side bolts (330090). Connectors are made of Lead Free Brass
	330067-LF	1"	Connector Assembly	

STRAP

	PART #	YOKE SIZE	DESCRIPTION	NOTES
	330070	3/4" and 1"	Strap for use with 3/4" and 1" connectors	U shaped strap for connector assemblies



Continued on next page...

Rayne (Yoke) Style Fittings *continued*

SIDE BOLT

	PART #	YOKE SIZE	DESCRIPTION	NOTES
	330090	3/4" and 1"	Side Bolt	Shoulder screw used to connect strap to connector body

CENTER BOLTS

	PART #	YOKE SIZE	DESCRIPTION	NOTES
	330081	3/4" and 1"	Center Bolt-S.S. Hex Head 5/16"-18-1.5"	Used to hold connector assemblies to tank fittings
	330082	3/4" and 1"	Center Bolt-Zinc Plated Square Head 5/16" - 18 - 1.5"	

NUTS

	PART #	YOKE SIZE	DESCRIPTION	NOTES
	330083	N/A	S.S. Nut	Used as replacement nuts on old style single and double straps
	330084	N/A	Yoke Strap Clip Nut	Alternative replacement nut for old style straps
	330085	3/4" and 1"	Center Bolt-S.S. Hex Head 5/16" - 18 - 1.75"	-

Continued on next page...

Rayne (Yoke) Style Fittings *continued*

O RINGS

	PART #	YOKE SIZE	DESCRIPTION	NOTES
	330160	3/4"	Yoke O-Ring	Standard sized O ring used on yokes. Oversized O-Ring (330161) is the recommended O ring for connectors
	330160-EPDM	3/4"	Yoke O-Ring	
	330161	3/4"	Yoke O-Ring Oversized	O-Ring for use with 330063-LF connector. Larger size creates better seal between yoke and connector

YOKE GASKET

	PART #	YOKE SIZE	DESCRIPTION	NOTES
	330162	1"	Yoke Gasket	Gasket for use with 330067-LF connector

3/4" TANK FITTINGS

	PART #	YOKE SIZE	DESCRIPTION	NOTES
	330310-LF	3/4"	Tank Fitting Brass - Outlet Lead Free Brass	No opening on top of fitting
	330300-LF	3/4"	Tank Fitting Brass - Inlet Lead Free Brass	Opening on top of fitting to allow for access to inlet distributor. 330020LF plug used to seal this opening

1" TANK FITTING

	PART #	YOKE SIZE	DESCRIPTION	NOTES
	330312-LF	1"	Tank Fitting - Lead Free Brass	Opening on top of fitting to allows access. 330022LF plug used to seal opening

Continued on next page...

Rayne (Yoke) Style Fittings *continued*

DISTRIBUTORS



PART #	YOKE SIZE	DESCRIPTION	NOTES
330361	3/4"	7" Dist. - Heavy Wall PVC	PVC rated to 130°F
330363	3/4"	7" Dist. - CPVC	CPVC is rated for 180°F
330364	1"	7" Dist. - PVC	PVC rated to 130°F
330365	1"	7" Dist. - CPVC	CPVC is rated for 180°F
330371	3/4"	9" Dist. - Heavy Wall PVC	PVC rated to 130°F
330373	3/4"	9" Dist. - CPVC	CPVC is rated for 180°F
330374	1"	9" Dist. - PVC	PVC rated to 130°F
330381	3/4"	11" Dist. - Heavy Wall PVC	PVC rated to 130°F
330383	3/4"	11" Dist. - CPVC	CPVC is rated for 180°F
330384	1"	11" Dist. - PVC	PVC rated to 130°F
330391	3/4"	35-1/2 Dist.	PVC rated to 130°F
330394	1"	35-3/4 Dist. - PVC	PVC rated to 130°F
330395	1"	35-3/4 Dist. - CPVC	CPVC is rated for 180°F

Continued on next page...

Rayne (Yoke) Style Fittings *continued*

INLET/OUTLET SPRINGS



PART #	YOKE SIZE	DESCRIPTION	NOTES
330040	3/4"	1 1/4" Spring	Used with 330300LF to hold distributor down
330042	1"	Inlet/Outlet Spring - Heavy Duty	Used with 330312LF to hold distributor down
330050	3/4"	2 1/2" Outlet Spring	Used in outlet tee on Servisoft tank
330051	1"	Outlet Spring	Used in outlet tee on Jupiter tank

DISC SCREEN



PART #	YOKE SIZE	DESCRIPTION	NOTES
330064	3/4" and 1"	Disc Screen (40 mesh) 1 3/8" Diameter	Screen sits under the O ring on the tank connector to create a safety screen to block resin in event of broken distributor. Compatible on 3/4" and 1" connector

TRANSPORT PLUG





PART #	YOKE SIZE	DESCRIPTION	NOTES
330065	3/4"	Transport Plug	Plug 3/4" tank fittings so no dirt/debris enters

Continued on next page...

Rayne (Yoke) Style Fittings *continued*

TANK FITTING PLUGS AND O-RINGS

	PART #	YOKE SIZE	DESCRIPTION	NOTES
	330020LF	3/4"	Plug Lead Free-Brass 5/8" - Hex Drive	Used on 330300-LF
	330022LF	1"	Plug Lead Free-Brass 5/8" - Hex Drive	Used on 330312-LF
	330031	1"	Plug-Zinc-Square Drive	Used on 330312-LF
	330130	3/4"	O-Ring 3/4" Plug	O-ring for 330020-LF
	330411	1"	O-Ring 1" Plug	O-ring for 330022-LF





DISTRIBUTOR GASKETS

	PART #	YOKE SIZE	DESCRIPTION	NOTES
	330033	1"	Distributor Gasket (1" Tank Coupling)	Used to seal distributor when the tank has 1" openings. Used under distributor flare
	330032	3/4"	Distributor Gasket (3/4" Tank Coupling)	Used to seal distributor when the tank has 3/4" openings. Used under distributor flare

Continued on next page...

Rayne (Yoke) Style Fittings *continued*

FILL PORT CAPS

	PART #	DESCRIPTION	NOTES
	331000	1 1/2 Zinc Cap Bar Drive	-
	331003SS	1 1/2 Stainless Cap - Square Drive	-
	331003SS - R	1 1/2 Stainless Cap - Square Drive	Threads have leader in order to avoid the cap becoming frozen due to hardness filling the bottom threads
	331004	1 1/2 Zinc Cap - Square Drive	Used on old galvanized Servisoft and Rayne tank fill port threads
	331003LFB	1 1/2 Lead Free Brass Cap - Square Drive	-
	331003LFB - R	1 1/2 Lead Free Brass Cap - Square Drive	Threads have leader in order to avoid the cap becoming frozen due to hardness filling the bottom threads
	330100	O-Ring-1 1/2 Cap	O-ring for use with 1.5" caps

**THIS PAGE IS
INTENTIONALLY
LEFT BLANK**

Park Style Fittings

FEATURES:

- Quick disconnect fittings sealed with an O-ring
- Quick disconnect fittings are made of NSF Grade glass filled noryl
- Plugs and caps are made of polypropylene
- Max limits: 260°F and 150 PSI
- O-rings are included for fittings requiring an O-ring
- MPT - Male Pipe Thread
- MUT - Male Union Thread
- FUT - Female Union Thread
- LHUT - Left Hand Union Thread
- IT - Inside Thread
- HB - Hose Barb

MPT X MUT



PART #	INDUSTRY PART #	SIZE	CONFIGURATION	NOTES
330400	MA-75	3/4"	MPT x MUT	-
330400 LHUT	-	3/4"	MPT x Reverse MUT	Reverse thread for extra safety measure against connecting wrong hose. Reverse thread fittings are white
330400-IT	-	3/4"	MPT x MUT with 1/2" threads	Inner threads allowing for 220311 distributor to be screwed into fitting
330404	MA-100	1"	MPT x MUT	-
330404 LHUT	-	1"	MPT x MUT Reverse MUT	Reverse thread for extra safety measure against connecting wrong hose. Reverse thread fittings are white

Continued on next page...

Park Style Fittings *continued*

MPT X FUT



PART #	INDUSTRY PART #	SIZE	CONFIGURATION	NOTES
330401	UMA-75	3/4"	MPT x FUT	-
330401 LHUT	-	3/4"	MPT x FUT Reverse MUT	Reverse thread for extra safety measure against connecting wrong hose. Reverse thread fittings are white
330401-IT	-	3/4"	MPT x FUT w 1/2" threads	Inner threads allowing for 220311 distributor to be screwed into fitting
330405	UMA-100	1"	MPT x FUT	-
330405 LHUT	-	1"	MPT x FUT Reverse FUT	Reverse thread for extra safety measure against connecting wrong hose. Reverse thread fittings are white

HB X MUT



PART #	INDUSTRY PART #	SIZE	CONFIGURATION	NOTES
330402	HB-75	3/4"	HB x MUT	-
330402 LHUT	-	3/4"	HB x MUT Reverse MUT	Reverse thread for extra safety measure against connecting wrong hose. Reverse thread fittings are white
330406	HB-100	1"	HB x MUT	-
330406 LHUT	-	1"	HB x MUT Reverse MUT	Reverse thread for extra safety measure against connecting wrong hose. Reverse thread fittings are white

Continued on next page...

Park Style Fittings *continued*

HB X FUT



PART #	INDUSTRY PART #	SIZE	CONFIGURATION
330403	UHB-75	3/4"	HB x FUT
330407	UHB-100	1"	HB x FUT

PLUGS



PART #	INDUSTRY PART #	SIZE	CONFIGURATION	NOTES
330408-B	PLUG-UN	3/4" and 1"	Plug - Black	Made of Polypropylene
330408-W		3/4" and 1"	Plug - White	Made of Polypropylene
330408 LHUT	-	3/4" and 1"	Plug - Reverse MUT	Made of Polypropylene

CAPS



PART #	INDUSTRY PART #	SIZE	CONFIGURATION	NOTES
330409-B	CAP-MA	3/4" and 1"	Cap - Black	Made of Polypropylene
330409-W		3/4" and 1"	Cap - White	Made of Polypropylene
330409 LHUT	-	3/4" and 1"	Cap - Reverse MUT	Made of Polypropylene

Continued on next page...

Park Style Fittings *continued*

O-RINGS



PART #	SIZE	NOTES
330411	3/4" and 1"	O-Ring (EPDM) - Standard O ring included with park fittings
330412	3/4" and 1"	O-Ring (Viton) - Viton O ring for Park Fittings - Higher chemical resistivity

INLET DISTRIBUTORS FOR PARK FITTINGS



PART #	SIZE	DESCRIPTION	NOTES
330410	3/4"	Inlet Distributor 3/4" PVC-Drop In	Large flange to allow distributor to sit in park fitting. Used with 2.5" heads with vertical in/out heads
330413B	1"	Inlet Distributor 1" Black PVC	Large flange to allow distributor to sit in park fitting. Used with 330507 4.5" head
330413-CPVC	1"	Inlet Distributor 1" CPVC	-

Continued on next page...



Park Style Fittings *continued*

3/4" PARK DI HOSE CONNECTORS

PART #	DESCRIPTION	NOTES
330416	330402 HB x 330403 UHB	
330417	330402 HB x 330402 HB	
330418	330414 PVC MPT x 330414 PVC MPT	
330419	330402 HB x 330414 MPT	
330420	330403 UHB x 330414 MPT	<p>When ordering Park Hose Assemblies please specify the configuration, hose material (Pages H11 and H12), and desired length. Any combination of hose barb fittings are available. Please call for pricing and availability</p>
330427	222012 1/2" SS x 330403	
330428	222012 1/2" SS x 330402	
330429	222011 3/4" SS x 330403	

Continued on next page...

Park Style Fittings *continued*

1" PARK DI HOSE CONNECTORS

PART #	DESCRIPTION	NOTES
330421	330406 HB x 330407 UHB	
330422	330406 HB x 330406 HB	
330423	330415 PVC MPT x 330415 PVC MPT	
330424	330406 HB x 330415 PVC MPT	
330425	330407 UHB x 330415 PVC MPT	

When ordering Park Hose Assemblies please specify the configuration, hose material (Pages H11 and H12), and desired length. Any combination of hose barb fittings are available. Please call for pricing and availability

2.5" - 8 Tank Threads - 3/4" Inlet and Outlet-ABS

FEATURES:

- Tank heads are made for 2.5" openings and all include a 3/4" inlet/outlet



PART #	DESCRIPTION	NOTES
330500-0.50	1/2" Dist. Port	Use drop in inlet screens – 220105 for Culligan slip fittings and 330410 for Park fittings
330600-1316	13/16" Dist. Port	



PART #	DESCRIPTION
330500-IS-0.50	1/2" Dist. Port with Glued on Inlet Screen
330600-IS-1316	13/16" Dist. Port with Glued on Inlet Screen



PART #	DESCRIPTION
330501-0.50	1/2" Dist. Port with 3/4" Fill Port
330700-IS-1316	13/16" Dist. Port available with 3/4" Fill Port



PART #	DESCRIPTION	NOTES
330501-IS-0.5	1/2" Dist. Port with 3/4" Fill Port and Glued on Inlet Screen	Available to be shipped complete on tanks
330700-IS-1316	13/16" Dist. Port with 3/4" Fill Port and Glued on Inlet Screen	

Continued on next page...

2.5" - 8 Tank Threads - 3/4" Inlet and Outlet-ABS *continued*

	PART #	DESCRIPTION	NOTES
	330502-0.50-0.75	1/2" Dist. Port with 3/4" Fill Port and Glued on Inlet Screen	Horizontal inlet/outlet
	330800-1316-340	13/16" Dist. Port with 3/4" Fill Port and Glued on Inlet Screen	
	330800-120-140	1/2" Dist. Port with 1/4" Fill Port and Glued on Inlet Screen available and 1/4" In/Out	
	330800-1316-140	13/16" Dist. Port with 1/4" Fill Port and Glued on Inlet Screen	

	PART #	DESCRIPTION	NOTES
	330503-0.50	1/2" Dist. Port	Horizontal inlet/outlet
	330800-340	3/4" Dist. Port	
	330503-0.8125	13/16" Dist. Port	

2.5" - 8 Tank Threads - 1" Inlet and Outlet-ABS

FEATURES:

- Tank heads are made for 2.5" openings and all include a 1" inlet/outlet

	PART #	DESCRIPTION	NOTES
	330505-1.00	1" Dist. Port	Horizontal inlet/outlet
	330505-0.75	3/4" Dist. Port	

2.5" - 8 Tank Threads - Noryl - 3/4" (1.05") distributor port

FEATURES:

- Noryl offers a higher strength material





PART #	DESCRIPTION	NOTES
330563-0.75	1" Inlet and Outlet with 3/4" Dist. Port	Horizontal inlet/outlet
330563-1.00	1" Inlet and Outlet with 1" Dist. Port	Horizontal inlet/outlet
330564	Inlet Screen for 330563	-
330564-S	Inlet Screen with SS Screws for 330563	-

4.5" - 8 Tank Threads - 1" Inlet and Outlet - Glass Filled ABS - Glued on Inlet - Screen - Stainless Bands

FEATURES:

- Tank Heads are made for 4.5" openings and all include a 1" inlet/outlet
- Below Tank Heads are available to be shipped with complete tanks

	PART #	DESCRIPTION	NOTES
	330506	1" Dist. Port with 1.5" Fill Port and Plug	Available to be shipped complete on tanks
	330507	1" Dist. Port with Inlet and Outlet Only and glued on inlet screen	Available to be shipped complete on tanks
	330507-NO IS	1" Dist. Port with Inlet and Outlet Only (no inlet screen)	-
	330508	1" Dist. port - 3rd 1" Top port – Optional include threaded outlet Dist. port, inlet diffuser, threaded inlet screen	Use #330512 for optional fill port plug

4" Tank Heads - Noryl - 1.5" Dist. Port

	PART #	DESCRIPTION	NOTES
	330565	1.5" Inlet and Outlet with 1.5" Dist. Port	Horizontal inlet/outlet
	330566	Inlet Screen for 330565	-

Fill Caps with O-Rings

FEATURES:

- Replacement fill caps with O-rings for tank heads

3/4" FILL CAP WITH O-RING

	PART #	Used on
	330510	330501

3/4" FILL CAP WITH O-RING

	PART #	Used on
	330511	330502

1" FILL CAP WITH O-RING

	PART #	Used on
	330512	330508

1.5" FILL CAP WITH O-RING

	PART #	Used on
	330513	330506

CH 1.5" FILL CAP BUSHING WITH 1" FPT CENTER HOLE

	PART #	Notes
	330513-CH	Used to convert the 1.5" fill port hole on the 330506 head to a 1" hole

O-Rings



FEATURES:

- O-Rings for use in tanks heads

PART #	DESCRIPTION	USED ON
330514	3/4" Fill Cap O-Ring	330501, 330502
330515	2.5" x 8 Tank Head O-Ring	2.5" Tank Heads
330509	1.5" Fill Cap O-Ring	330513, 330513-CH
330517	4.5" x 8 Tank Head O-Ring	4.5" Tank Heads
330550	4.5" x 8 Riser and 1" Fill Cap O-Ring	330506, 330507, 330508, 330505 Heads, 330512 Fill Port Plug
330554	1/2" Riser Tube O-Ring	330500, 330501-IS, 330501, 330501-IS, 330502, 330503

Inlet Diffusers, Screens, and Distributors

FEATURES:

- Inlet screens and diffusers for tank heads

2.5" INLET SCREEN

PART #	DESCRIPTION	USED ON
330519	Inlet Screen 2.5" Adapters - Glued on	330500-IS, 330501-IS

2.5" INLET SCREEN

PART #	DESCRIPTION	USED ON
330531	Inlet Screen 2.5" Adapters - Glued on	330505

4.5" INLET DIFFUSER

PART #	DESCRIPTION	USED ON
330520	Inlet Diffuser 4.5" Adapters - Glued on	330506, 330507, 330508

4.5" INLET SCREEN

PART #	DESCRIPTION	USED ON
330552	Inlet Screen 4.5" Adapters - Glued on	330506, 330507, 330509



Outlet Distributor / Basket



FEATURES:

- 7 slots is commonly referred to as a “Stack”

PART #	DESCRIPTION
330521	1" x 1 Stack Offset Outlet Distributors/Baskets - 7 slots
330522	1" x 2 Stack Offset Outlet Distributors/Baskets - 14 slots
330523	1" x 3 Stack Offset Outlet Distributors/Baskets - 21 slots
330524	1" x 4 Stack Offset Outlet Distributors/Baskets - 28 slots
330525	1" x 2 Stack Offset Hot Water Distributors/Baskets - 14 slots
330526	1" x 4 Stack Offset Hot Water Distributors/Baskets - 28 slots
330527	1.5" x 1 Stack Outlet Distributors/Baskets - 7 slots
330528	1.5" x 2 Stack Outlet Distributors/Baskets - 14 slots
330529	1.5" x 3 Stack Outlet Distributors/Baskets - 21 slots
330530	1.5" x 4 Stack Outlet Distributors/Baskets - 28 slots

Continued on next page...

Outlet Distributor / Basket *continued*

OUTLET DISTRIBUTOR / BASKET



PART #	DESCRIPTION
330533	1" Outlet Distributor/Basket

OUTLET DISTRIBUTOR / BASKET



PART #	DESCRIPTION
330534	13/16" (0.810 OD) Outlet Distributors/Baskets

OUTLET DISTRIBUTOR / BASKET



PART #	DESCRIPTION
330535	1/2" (0.845 OD) Outlet Distributors/Baskets 180 degree Distributor

OUTLET DISTRIBUTOR / BASKET



PART #	DESCRIPTION
330535HW	1/2" (0.845" OD) Hot Water Outlet Distributor/Basket

OUTLET DISTRIBUTOR / BASKET

PART #	DESCRIPTION
330536	3/4" (1.050) Outlet Distributors/Baskets

Tank Bushings

FEATURES:

- Used to reduce the size of a tank opening

PART #	DESCRIPTION
330539	2.5" x 4" - converts 4" tank opening to 2.5"
330540	2.5" x 4.5" - converts 4.5" tank opening to 2.5"

CAPS

PART #	DESCRIPTION	USED ON
330537	2.5" x 8 Cap	Tanks with 2.5" openings
330538	2.5" x 8 Flanged Cap	Tanks with 2.5" openings

Outlet Safety Screens - PVC Drop In

FEATURES:

- Protects downstream from outlet manifold/distributor breakage



PART #	DESCRIPTION	NOTES
330431	2.5" Head 3.125" PVC outlet screen	For use with 330500, 330501
330432	4.5" Head 2.625" PVC outlet screen	For use with 330506, 330507, 330508

DI Tanks



FEATURES:

- Please call for availability on other tank sizes. We have access to tanks ranging from small 6" x 13" to commercial sizes 63" x 67"
- Tanks are available in Natural, Black, Blue and more colors. Please call for availability
- Please call for availability on Enpress or Structural Fibers Tanks
- RB = Rubber Base
- SB = Standard Base
- Reinforced plastic bases are available for DI Tanks
- 2.5" tank opening size complete tanks come with a 330501-IS tank head (3/4" in/out, 3/4" fill port & plug), glued on inlet screen, riser & basket
- All tanks are available as complete or incomplete assemblies

PART #	SIZE (W x H)	TANK OPENING SIZE	COLOR	CAPACITY (GPM)	QTY PER PALLET	NOTES
AMF835WC-N-RB-C	8" x 35"	2.5"	Natural	6.6	24	Complete Tank with Rubber Base. 2.5" tank opening size complete tanks come with a 330501-IS tank head (3/4" in/out, 3/4" fill port) and glued on inlet screen
AMF835WC-N-SB-C	8" x 35"	2.5"	Natural	6.6	24	Complete Tank with Standard Plastic Base. 2.5" tank opening size complete tanks come with a 330501-IS tank head (3/4" in/out, 3/4" fill port) and glued on inlet screen
AMF844WC-N-RB	8" x 44"	2.5"	Natural	8.5	24	–
AMF844WC-BK-RB	8" x 44"	2.5"	Black	8.5	24	–
AMF844WC-N-RB-C	8" x 44"	2.5"	Natural	8.5	24	Complete Tank with Rubber Base. 2.5" tank opening size complete tanks come with a 330501-IS tank head (3/4" in/out, 3/4" fill port) and glued on inlet screen
AMF844WC-N-SB	8" x 44"	2.5"	Natural	8.5	24	–
AMF844WC-N-RB-C	8" x 44"	2.5"	Natural	8.5	24	Complete Tank with Rubber Base. 2.5" tank opening size complete tanks come with a 330501-IS tank head (3/4" in/out, 3/4" fill port) and glued on inlet screen

Continued on next page...

DI Tanks *continued*

PART #	SIZE (W x H)	TANK OPENING SIZE	COLOR	CAPACITY (GPM)	QTY PER PALLET	NOTES
AMF940WC-N-RB-C	9" x 40"	2.5"	Natural	9.8	24	Complete Tank with Rubber Base. 2.5" tank opening size complete tanks come with a 330501-IS tank head (3/4" in/out, 3/4" fill port) and glued on inlet screen
AMF940WC-N-SB-C	9" x 40"	2.5"	Natural	9.8	24	Complete Tank with Standard Plastic Base. 2.5" tank opening size complete tanks come with a 330501-IS tank head (3/4" in/out, 3/4" fill port) and glued on inlet screen
AMF942WC-N-RB-C	9" x 42"	2.5"	Natural	10.3	24	Complete Tank with Rubber Base. 2.5" tank opening size complete tanks come with a 330501-IS tank head (3/4" in/out, 3/4" fill port) and glued on inlet screen
AMF942WC-N-SB-C	9" x 42"	2.5"	Natural	10.3	24	Complete Tank with Standard Plastic Base. 2.5" tank opening size complete tanks come with a 330501-IS tank head (3/4" in/out, 3/4" fill port) and glued on inlet screen
AMF942WC-N-RB	9" x 42"	2.5"	Natural	10.3	24	–
AMF942WC-N-SB	9" x 42"	2.5"	Natural	10.3	24	–
AMF948WC-N-RB	9" x 48"	2.5"	Natural	11.9	24	–
AMF948WC-N-RB-C	9" x 48"	2.5"	Natural	11.9	24	Complete Tank with Rubber Base. 2.5" tank opening size complete tanks come with a 330501-IS tank head (3/4" in/out, 3/4" fill port) and glued on inlet screen
AMF948WC-N-RB	9" x 48"	2.5"	Natural	11.9	24	–
AMF948WC-N-SB-C	9" x 48"	2.5"	Natural	11.9	24	Complete Tank with Standard Plastic Base

Continued on next page...

DI Tanks *continued*

PART #	SIZE (W x H)	TANK OPENING SIZE	COLOR	CAPACITY (GPM)	QTY PER PALLET	NOTES
AMF1040WC-N-RB-C	10" x 40"	0.888"	Natural	12.1	20	-
AMF1040WC-N-SB-C	10" x 40"	2.5"	Natural	12.1	20	Complete Tank with Standard Plastic Base
AMF1054WC-N-RB-C	10" x 54"	2.5"	Natural	16.5	20	-
AMF1054WC-N-SB-C	10" x 54"	2.5"	Natural	16.5	20	Complete Tank with Standard Plastic Base
AMF1236WC-BL-RB	12" x 36"	4.5"	Blue	15.1	12	-
AMF1236WC-N-RB	12" x 36"	4.5"	Natural	15.1	12	-
AMF1242WC-N-RB-C506	12" x 42"	4.5"	Natural	18	12	Complete tank comes with 330506 tank head (1" in/out, 1.5" fill port & plug), glued on inlet screen, riser & 14 slot offset basket
AMF1242WC-N-RB	12" x 42"	4.5"	Natural	18	12	-
AMF1248WC-N-SB	12" x 48"	4.5"	Natural	20.8	12	-
AMF1252WC-N-RB	12" x 52"	4.5"	Natural	22.9	12	-

Continued on next page...

DI Tanks *continued*

PART #	SIZE (W x H)	TANK OPENING SIZE	COLOR	CAPACITY (GPM)	QTY PER PALLET	NOTES
AMF1252WC-N-RB-C506	12" x 52"	4.5"	Natural	22.9	12	Complete tank comes with 330506 tank head (1" in/out, 1.5" fill port & plug), glued on inlet screen, riser & 14 slot offset basket
AMF1252WC-N-RB-C508	12" x 52"	4.5"	Natural	22.9	12	Complete tank comes with 330508 tank head (1" in/out, 1" fill port & plug), glued on inlet screen, riser & 14 slot offset basket
AMF1252WC-N-RB-C507	12" x 52"	4.5"	Natural	22.9	12	Complete tank comes with 330507 tank head (1" in/out), glued on inlet screen, riser & 14 slot offset basket
AMF1252WC-N-SB	12" x 52"	4.5"	Natural	22.9	12	Complete Tank with Standard Plastic Base

AMF1447WC-N-RB	14" x 47"	4.5"	Natural	–	12	–
AMF1447WC-N-RB-C506	14" x 47"	4.5"	Natural	–	12	Complete tank comes with 330506 tank head (1" in/out, 1.5" fill port & plug), glued on inlet screen, riser & 14 slot offset basket
AMF1447WC-N-RB-C508	14" x 47"	4.5"	Natural	–	12	Complete tank comes with 330508 tank head (1" in/out, 1" fill port & plug), glued on inlet screen, riser & 14 slot offset basket
AMF1447WC-N-RB-C507	14" x 47"	4.5"	Natural	–	12	Complete tank comes with 330507 tank head (1" in/out), glued on inlet screen, riser & 14 slot offset basket
AMF1447WC-N-SB	14" x 47"	4.5"	Natural	–	12	Complete Tank with Standard Plastic Base
AMF1465WC-N-RB	14" x 65"	4.5"	Natural	–	12	Complete Tank with Standard Plastic Base



Continued on next page...

Residential Tanks

FEATURES:

- Fiberglass tanks with no rubber bumper, available with multiple base options

	PART #	SIZE	TANK OPENING SIZE	COLOR	NOTES	QTY PER PALLET
	AMR-0613-25-BK	6"	2.5"	Black	Also available in Blue	–
	AMR-0618-25-B-NB	6"	2.5"	Blue	No base	–
	AMR-0618-25-N	6"	2.5"	Natural	Also available in Blue and Black	–
	AMR-0618-25-EU-NB	6"	2.5"	European Blue	No base	–
	AMR-0635-25-N	6"	2.5"	Natural	Also available in Blue and Black	–
	AMR-0713-25-BK	7"	2.5"	Black	–	–
	AMR-0818-25-N	8"	2.5"	Natural	Also available in Blue and Black	24
	AMR-0824-25-B	8"	2.5"	Blue	Also available in European Blue	24
	AMR-0830-25-N	8"	2.5"	Natural	Also available in Black	24
	AMR-0835-25-N	8"	2.5"	Natural	Also available in Blue and Black	24
	AMR-0840-25-N	8"	2.5"	Natural	–	24
	AMR-0844-25-N	8"	2.5"	Natural	Also available in Blue and Black	24

Continued on next page...

Residential Tanks *continued*



PART #	SIZE	TANK OPENING SIZE	COLOR	NOTES	QTY PER PALLET
AMR-0918-25-N	9"	2.5"	Natural	Also available in Blue and Black	24
AMR-0942-25-N	9"	2.5"	Natural	Also available in Blue and Black	24
AMR-0948-25-N	9"	2.5"	Natural	Also available in Blue and Black	24
AMR-1013-25-BK-DH	10"	2.5"	Black	Dome hole, Plug and seal included	20
AMR-1017-25-N	10"	2.5"	Natural	–	20
AMR-1018-25-BK	10"	2.5"	Black	–	20
AMR-1035-25-BK	10"	2.5"	Black	–	20
AMR-1044-25-BK-DH	10"	2.5"	Black	Dome hole, Plug and seal included	20
AMR-1044-25-N	10"	2.5"	Natural	Also available in Black	20
AMR-1044-25-N-DH	10"	2.5"	Natural	Dome hole, Plug and seal included	20
AMR-1047-25-N	10"	2.5"	Natural	Also available in Black	20
AMR-1047-25-N-DH	10"	2.5"	Natural	Dome hole, Plug and seal included	20
AMR-1054-25-25-N	10"	2.5"	Natural	Also available in Blue and Black	20

Continued on next page...

Residential Tanks *continued*



PART #	SIZE	TANK OPENING SIZE	COLOR	NOTES	QTY PER PALLET
AMR-1054-25-B-DH	10"	2.5"	Blue	Dome hole, Plug and seal included	20
AMR-1054-25-BK-DH	10"	2.5"	Black	Dome hole, Plug and seal included	20
AMR-1054-25-G-DH	10"	2.5"	Grey	Dome hole, Plug and seal included	20
AMR-1054-25-N	10"	2.5"	Natural	Also available in Black and Grey	20
AMR-1054-25-N-DH	10"	2.5"	Natural	Dome hole, Plug and seal included	20
AMR-1236-25-BK-DH	12"	2.5"	Black	Dome hole, Plug and seal included	12
AMR-1236-25-N	12"	2.5"	Natural	Also available in Black	12
AMR-1236-25-N-DH	12"	2.5"	Natural	Dome hole, Plug and seal included	12

Continued on next page...

Residential Tanks *continued*



PART #	SIZE	TANK OPENING SIZE	COLOR	NOTES	QTY PER PALLET
AMR-1248-25-BK	12"	2.5"	Black	–	12
AMR-1248-25-N-DH	12"	2.5"	Natural	Dome hole, Plug and seal included	12
AMR-1252-25-N	12"	2.5"	Natural	–	12
AMR-1252-25-N-DH	12"	2.5"	Natural	Dome hole, Plug and seal included	12
AMR-1252-4-4-N-DH-SB	12"	4"	Natural	Dome hole, Plug and seal included	12
AMR-1252-4-4-N-SB	12"	4"	Natural	–	12



AMR-1354-25-BK-DH	13"	2.5"	Black	Dome hole, Plug and seal included	12
AMR-1354-25-N	13"	2.5"	Natural	–	12
AMR-1354-4-25-BK	13"	4"	Black	–	12

Stainless Steel Tanks

FEATURES:

- All stainless steel tanks are made of 304 rated stainless steel unless otherwise noted.
- 304 stainless steel is not recommended for carbon. Please use 316SS or fiberglass for this application.
- 304 SS - 140 F and 100 PSI
- 316 SS - 200 F and 100 PSI
- Please call for 316 SS pricing and availability

CULLIGAN STYLE - TWO 3/4" THREADED TOP OPENING



PART #	SIZE (W X H)	SIDE SHELL THICKNESS	HEAD THICKNESS	QTY PER PALLET
AMC-944-304	9" x 44"	14GA	12GA	25
AMC-944-316	9" x 44"	14GA	12GA	25
AMC-944-316-BR	9" x 44"	14GA	12GA	25
AMC-944-304-BR	9" x 44"	14GA	12GA	25
AMC-844-304	8" x 44"	14GA	12GA	30
AMC-744-304	7" x 44"	14GA	14GA	36
AMC-744-316	7" x 44"	14GA	14GA	36
AMC-819-304	8" x 19"	14GA	12GA	50
AMC-819-316	8" x 19"	14GA	12GA	50

Continued on next page...



Stainless Steel Tanks *continued*

CULLIGAN STYLE WITH ONLY A 2.5-8 THREADED TOP OPENING

PART #	Size (W x H)	SIDE SHELL THICKNESS	HEAD THICKNESS	QTY PER PALLET
AMD-1054-304	10" x 54"	14GA	12GA	20
AMD-1052-304	10" x 52"	14GA	12GA	20
AMD-1048-304	10" x 48"	14GA	12GA	20
AMD-1044-304	10" x 44"	14GA	12GA	20
AMD-948-304	9" x 48"	14GA	12GA	25
AMD-944-304	9" x 44"	14GA	12GA	25
AMD-848-304	8" x 48"	14GA	12GA	30
AMD-840-304	8" x 40"	14GA	12GA	30
AMD-744-304	7" x 44"	14GA	14GA	36
AMD-1054-316	10" x 54"	14GA	12GA	CALL

Continued on next page...

Stainless Steel Tanks *continued*

RAYNE STYLE TANKS - TWO 1" AND ONE 1.5" TOP OPENING



PART #	Size (W x H)	SIDE SHELL THICKNESS	HEAD THICKNESS	QTY PER PALLET
AMS-61	10" x 38"	14GA	12GA	20
AMS-45	8" x 38"	14GA	12GA	30
AMS-28	6" x 38"	14GA	12GA	36
AMS-61B - TOP HANDLE	10" x 38"	14GA	12GA	20

SPECIAL SIZE RAYNE STYLE (NO HANDLE)

PART #	Size (W x H)	SIDE SHELL THICKNESS	HEAD THICKNESS	QTY PER PALLET
AMR-1040	10" x 40"	14GA	12GA	20
AMR-1044	10" x 44"	14GA	12GA	20
AMR-1048	10" x 48"	14GA	12GA	20

Continued on next page...



Stainless Steel Tanks *continued*

**SERVISOFT STYLE - ONE 3/4" AND ONE 1.5" TOP OPENING
AND ONE 3/4" LOWER SIDE OPENING**

PART #	Size (W x H)	SIDE SHELL THICKNESS	HEAD THICKNESS	QTY PER PALLET
AM-54	10" x 38"	14GA	12GA	20
AM-36	8" x 38"	14GA	12GA	30
AM-24	6" x 38"	14GA	12GA	36
AM-25	8" x 29"	14GA	12GA	30

Continued on next page...



Bypasses

FEATURES:

- Bypasses are made of LF Brass
- Used to divert water while tanks are being serviced or swapped out

PART #	DESCRIPTION	MATERIAL
4400LF	3/4" Sweat x 3/4" Thread	LF Brass
4401LF	3/4" Thread x 3/4" Thread	LF Brass
4402LF	3/4" Sweat x 3/4" Sweat	LF Brass
4410LF	1" Sweat x 1" Sweat	LF Brass
4411LF	1" Sweat x 1" Thread	LF Brass
4412LF	1" Sweat x 3/4" Thread	LF Brass
4413LF	1" Thread x 1" Thread	LF Brass

Continued on next page...

Bypasses *continued*

BYPASSES O-RINGS AND ACCESSORIES

	PART #	DESCRIPTION
	4445	Buna O-Ring (Standard)
	4445-EPDM	EPDM O-Ring
	4446	Buna Quad-Ring (Standard)
	1078037	Service Sticker
	1078160	Bypass Sticker
	3464	Watts Culligan Style Push Rod - Complete with 4 O-Rings
	4444	Watts Divertaflo Style Push Rod - Complete with 2 O-Rings and 2 Quad Rings
	4420	Push Rod-Delrin 7-15/16"

Tank Carts - Standard and Side Loader

FEATURES:

- 1" x 14 gauge (.083) cold rolled steel tubing
- Mig Welded
- Black texture - powder coated
- 3/4" solid steel axle
- 12" pneumatic slick wheels with 3 piece hubs and roller bearings
- Capacity of 800 lbs.
- UPS shippable (45 x 20 x 17)
- Tank cart heights measured in laid back position. This must be taken into account when comparing height to other carts
- Specially designed to cradle mineral and resin tanks

STANDARD CART

PART #	DESCRIPTION	SIZE	WEIGHT
500000	Standard Tank Cart - Tanks up to 12" diameter	21"W x 45"H	35 lbs.

STANDARD CART WITHOUT BOTTOM LOOPS

PART #	DESCRIPTION	SIZE	WEIGHT
500010	Standard Tank Cart Without Bottom Loops - Tanks up to 10" diameter	21"W x 45"H	34 lbs.

LARGE TANK CART

PART #	DESCRIPTION	SIZE	WEIGHT
550000	For use with tanks up to 18" in diameter, Recommended to be shipped via truck to save on freight costs	24"W x 45"H	36 lbs.

DOUBLE TANK CART

PART #	DESCRIPTION	SIZE	WEIGHT
560000	Two Tanks up to 12" Diameter One Tank up to 30" Diameter, Recommended to be shipped via truck to save on freight costs	26"W x 46"H	51 lbs.

SIDE LOADER CARTS

PART #	DESCRIPTION	SIZE	WEIGHT
500020	Side Loader Cart - Tanks up to 9" diameter	20"W x 44"H	29 lbs.
500030	Side Loader Cart - Tanks up to 14" diameter	23.5"W x 44"H	34 lbs.

Salt Cart and Bottle Water Carts

SALT CART

	PART #	DESCRIPTION	SIZE	WEIGHT
	570000	Cart features 10" pneumatic treaded tires, 500 lbs. capacity, aluminum construction, stair climbers, wheel guards, and a curved back. Bottom plate measures 12" x 14". Other tires available.	21.5" W x 49" H	32 lbs.

3 POSITION BOTTLE WATER CART

	PART #	DESCRIPTION	WEIGHT
	520000	Easily converts from standard 2 wheel to 4 wheel inclined to 4 wheel platform truck. Carries up to 12 bottles Bottom Plate: 18" W x 7.5" D Recessed Nose: 9" W x 27" D, 300 lbs. capacity 2 Wheel Dimensions - 51" H x 21" W, 500 lbs. capacity 4 Wheel Dimensions - 40" H x 21" W x 54" L, 750 lbs. capacity	43 lbs.

5-BOTTLE HAND TRUCK

	PART #	DESCRIPTION	SIZE	WEIGHT
	510000	Non slip trays easily fold to convert this cart into a standard hand truck Aluminum Frame Bottom Plates: 14" W x 12" D	21.5" W x 49" H	28 lbs.

Cart Parts

FEATURES:

- Parts and accessories for use with tank carts and bottle water carts

PART #	DESCRIPTION	NOTES
500001	12" Slick Wheel for Tank Carts	4.10 x 3.5 - 6 with 3/4" roller bearing and offset hub. Used on 500000, 500010, 550000, 560000
500002	12" Treaded Wheel	Used on 500000, 500010, 550000, 560000
500003	12" Inner Tube	Used in 500001, 500002
500004	5/8" Ball Bearing Set	For use in 510008, 510008FF, 510001
500005	3/4" Bearing Ball Bearing Set	-
500006	3/4" Roller Bearing	For use on 500001
500008	Salt Plate for Tank Cart	For use on 500000, 500010
510001	10" Slick Wheel Assembly for Bottled Water Cart	For use with 570000, 520000, 510000



Cart Parts *continued*

PART #	DESCRIPTION	NOTES
510008	10" Treaded Wheel Assembly for Bottled Water Cart	For use with 570000, 520000, 510000
510008FF	10" Treaded Flat Free Wheel Assembly for Bottled Water Cart	For use with 570000, 520000, 510000
510003	Stair Climber for Bottled Water Cart	For use with 570000, 510000
510004	Bottom Tray for Bottled Water Cart	For use with 510000
510005	Upper Trays for Bottled Water Cart	For use with 510000
510006	Bottom Plate for Bottled Water Cart (H nose)	For use with 570000, 520000, 510000
510007	Tray Kit (5 bottle)	For use with 510000

Carrying Slings and Aprons

FEATURES:

- Most slings/aprons are not stocked. Please expect 2-3 week lead time for items to be produced

SLINGS (CUSTOM SIZES AVAILABLE)



PART #	DESCRIPTION
500070	Sling - Small 32"
500071	Sling - Medium 34"
500072	Sling - Large 36"
500073	Sling - X-Large 38"
500074	Sling - XX-Large 40"

APRONS

PART #	DESCRIPTION
500021	Reinforced Water Resistant Apron
500450	Backwash Apron

**THIS PAGE IS
INTENTIONALLY
LEFT BLANK**

Eductors

FEATURES:

- Flexible flow control orifice automatically maintains a constant flow regardless of variations in inlet water pressure.
- Corrosion resistant materials of construction: eductor body: schedule 80 polyvinylchloride; PVC Type 1, Grade 1; Flow control insert: precision molded buna (N)
- Wide operating pressure range: 30-120 PSIG; Maximum operating temperature: 100°F
- Standard models available from stock; custom configurations available on request
- Other materials of construction available

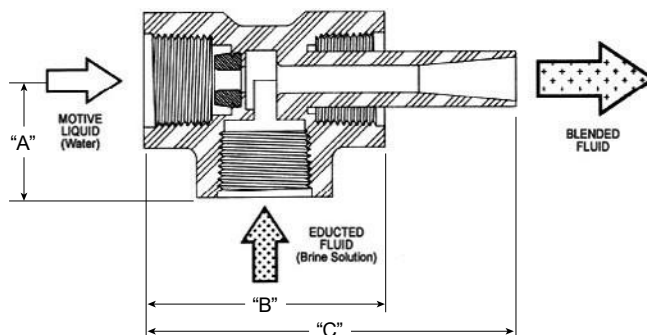

IMPORTANT APPLICATION NOTES:

These eductors are designed for operation with water as the operating medium. All applications should be carefully tested for flow characteristics and compatibility of the motive liquid and educted chemicals to insure desired results. Swelling of the flow control insert in certain liquids will result in loss of flow rate accuracy.

PART #	MOTIVE WATER FLOW RATE	PIPE SIZE	"A"	"B"	"C"
0.9-050	0.9 GPM	1/2	1.35	2.74	N/A
1.2-050	1.2 GPM				
1.4-050	1.4 GPM				
2.0-050	2.0 GPM	3/4	1.62	3.22	4.4
2.5-075	2.5 GPM				
3.5-075	3.5 GPM				
5.0-075	5.0 GPM	1	1.85	3.64	5.45
7.0-100	7 GPM				
10-100	10 GPM				

Continued on next page...

Eductors *continued*

PART #	MOTIVE WATER FLOW RATE	PIPE SIZE	"A"	"B"	"C"
12-150	12 GPM	1-1/2	2.09	4.16	6.05
15-150	15 GPM				
20-150	20 GPM				

TYPICAL WATER SOFTENER APPLICATIONS

Tank Dia.	Area Sq. Ft.	Resin Volume, Cu. Ft.		Eductoret Model No:	Rinse GPM
		Min. (1)	Max. (2)		
12	0.8	1.6	3.1	0.9-050	0.9
14	1.1	2.1	4.3	1.2-050	1.2
16	1.4	2.8	5.6	1.4-050	1.4
18	1.8	3.5	7.1	2.0-050	2
20	2.2	4.4	8.7	2.5-075	2.5
24	3.1	6.3	12.6	3.5-075	3.5
30	4.9	9.8	19.6	5.0-075	5
36	7.1	14.1	28.3	7-100	7
42	9.6	19.2	38.5	10-100	10
48	12.6	25.1	50.3	12-150	12
54	15.9	31.8	63.6	15-150	15
60	19.6	39.3	78.5	20-150	20

Model No.	Pipe Size (NPT)
0.9-050	1/2
1.2-050	1/2
1.4-050	1/2
2.0-050	1/2
2.5-075	3/4
3.5-075	3/4
5.0-075	3/4
7.0-100	1
10-100	1
12-150	1 1/2
15-150	1 1/2
20-150	1 1/2

No Adjustable Throat or Nozzle.		
00-200	2"	122.09
00-250	2.5"	203.1

(1) Based on 24" minimum bed depth.

(2) At minimum 0.25 GMP/Cu. Ft. rinse rate.

(3) Regeneration with saturated salt (NaCl) brine as the educted liquid will yield brine flow < rinse flow. The ratio is dependent on many factors including discharge head (pipe design, bed depth, installation, etc.) and suction lift (brine valve design and size, installation, etc.)

Note: Above eductors not recommended for use with DI regen chemicals. Call for special DI eductor pricing.

Flow Controls



FEATURES:

- Restrict the flow of liquid
- Buna flow control inserts are not recommended for DI regenerative chemicals. Call for pricing on special DI flow controls.
- When ordering, please specify the flow rate you would like along with the model number.

FLOW RATE GPM (1)	NO. OF INSERTS (2)	PIPE SIZE	PVC – THREADED N.P.T.		PVC – PLAIN END	
			MODEL NO.	LENGTH (IN)	MODEL NO.	LENGTH (IN)
0.25-3.5	1	0.50	TH-050-1	2	PE-050-1	5
0.25-10	1	0.75	TH-075-1	2	PE-075-1	5
5-10	1	1.00	TH-100-1	3	PE-100-1	6
12,15,20	1	1.00	TH-100-1C	3	PE-100-1C	6
10-20	2	1-1/4	TH-125-2	3	PE-125-2	6
20-40	4	1-1/2	TH-150-4	3	PE-150-4	6
35-70	7	2.00	TH-200-7	3	PE-200-7	6
45-90	9	2-1/2	TH-250-9	4	PE-250-9	6
70-140	14	3.00	TH-300-14	4	PE-300-14	6
125-250	25	4.00	TH-400-25	4	PE-400-25	6
270-570	54	6.00	TH-600-54	5	PE-600-54	8

Continued on next page...

Flow Controls *continued*



FLOW RATE GPM (1)	NO. OF INSERTS (2)	PIPE SIZE	PVC – FLANGED		STEEL – THREADED N.P.T.	
			MODEL NO.	LENGTH (IN)	MODEL NO.	LENGTH (IN)
0.25-3.5	1	0.50	FL-050-1	5	–	–
0.25-10	1	0.75	FL-075-1	5	ST-075-1	2.5
5-10	1	1.00	FL-100-1	6	ST-100-1	3
12,15,20	1	1.00	FL-100-1C	6	ST-100-1C	3
10-20	2	1-1/4	FL-125-2	6	ST-125-2	3
20-40	4	1-1/2	FL-150-4	6	ST-150-4	3
35-70	7	2.00	FL-200-7	6	ST-200-7	3
45-90	9	2-1/2	FL-250-9	6	ST-250-9	4
70-140	14	3.00	FL-300-14	6	ST-300-14	4
125-250	25	4.00	FL-400-25	6	ST-400-25	4
270-570	54	6.00	FL-600-54	8.5	ST-600-54	5

Continued on next page...

Flow Controls *continued*

BRASS FLOW CONTROLS

FLOW RATE GPM (1)	NO. OF INSERTS (2)	PIPE SIZE	THREADED N.P.T.	
			MODEL NO.	LENGTH (IN)
0.25-3.5	1	1/2	BR1-050-1	2
5-10	1	1/2	BR2-050-1	2

DISC FLOW CONTROLS

FLOW RATE GPM (1)	NO. OF INSERTS (2)	PIPE SIZE	DISC (3)	
			MODEL NO.	LENGTH (IN)
35-70	7	2	D1-200-1	15/16
45-90	9	2.5	D1-250-9	15/16
70-140	14	3	D1-300-14	15/16
125-250	25	4	D1-400-25	15/16
270-540	54	6	D1-600-54	15/16

(1) Flow rates are for 3/4" through 6" flow controllers with flow rates from 5-540 GPM are in increments of 1 GPM. See Table B.

Flow rates for 1/2" and 3/4" flow controllers for flow rates from 0.25 to 3.5 GPM. See Table A.

Only flow rates 12, 15 and 20 GPM are available in Model No. 100-1C. See Table C.

Flow rates for 1/2" Brass 0.25 to 10 GPM. See Tables A and B.

(2) Maximum number of flow inserts in a given nipple size. Flow Controls can be made with fewer flow inserts, for less flow than minimum listed. Indicated prices will apply.

(3) Installs between two standard flanges, bolts must be a minimum of 1" longer than normally required. Gasket required on both sides.

TABLE A		TABLE B		TABLE C	
Inserts 0.25 to 3.5 GPM Buna Not color coded (Black)		Color Identification of BUNA Inserts		Inserts 12-20 GPM Buna Not color coded (Black)	
0.25 GPM	1.40 GPM	5 GPM -- Blue		12 GPM	
0.40 GPM	1.60 GPM	6 GPM - Red		15 GPM	
0.50 GPM	1.80 GPM	7 GPM - Brown		20 GPM	
0.60 GPM	2.00 GPM	8 GPM - Green			
0.70 GPM	2.20 GPM	9 GPM - White			
0.90 GPM	2.50 GPM	10 GPM - Rust			
1.00 GPM	3.00 GPM				
1.20 GPM	3.50 GPM				

**THIS PAGE IS
INTENTIONALLY
LEFT BLANK**

DI Funnels

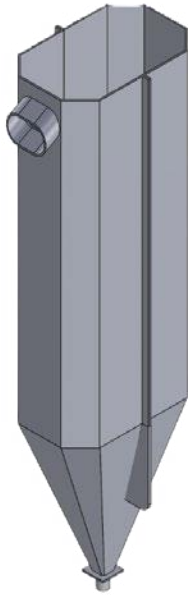

FEATURES:





- Funnels for DI and PE tank regeneration
- Clear Acrylic Construction
- Designed and manufactured in Chicago, IL
- Designed to fit into existing racks with minimal modification
- Troughs are available

PART #	SIZE
500700	11.75" x 16" x 60" - Capacity 3.69 Cubic Ft
500701	11.75" x 16" x 72" - Capacity 4.98 Cubic Ft
500702	11.75" x 16" x 82" - Capacity 5.6 Cubic Ft
500703	20.5" x 21" x 60" - Capacity 6.23 Cubic Ft
500704	20.5" x 21" x 72" - Capacity 8.2 Cubic Ft

DI Funnel Parts

FEATURES:

- For use in DI regeneration set up utilizing a funnel
- Please find Funnels on page H71

	PART #	DESCRIPTION	NOTES
	230431	Brass Backwash Adaptor - Plastic Yoke Tanks	-
	230540	Rubber Boot/Funnel Connector	"Accordion" boot to connect funnel to tank
	230430	Stainless Steel Conical Adapter (Funnel connector)	-
	230561	Stainless Steel DI Funnel Valve 1 5/8" x 5/8" OD Spout	-
	230561-REBUILD KIT	Stainless Steel DI Funnel Valve Repair Kit	Includes 230561 internals
	230560	Bronze Softener/Filter Funnel Valve - 1.25" female threaded openings	-
	230100	Funnel Down Spout Hose Flat Dimension 8" x 94" (Custom sizes available)	-



Misc.

RESIN OVERFLOW BAG

PART #	DESCRIPTION
330571	Measures 10" x 60", Custom sizes available

0-100 SALOMETER



PART #	DESCRIPTION
500500	For measuring brine

DI DUAL READ HYDROMETER



PART #	DESCRIPTION
500501	Used to measure acid and caustic

SOFT WATER TEST KIT

PART #	DESCRIPTION
500553	For testing water softness

Misc. *continued*

SINGLE TANK HOLDER-CLAMP STYLE

	PART #	DESCRIPTION
	500040	Used for mounting single tank to delivery truck

DOUBLE TANK HOLDER-CLAMP STYLE

	PART #	DESCRIPTION
	500041	Used for mounting two tanks to delivery truck

SPRINGS

	PART #	DESCRIPTION
	500044	Used on 500040 and 500041

ADJUSTERS

	PART #	DESCRIPTION
	500045	Used on 500040 and 500041

Misc. *continued*

ALUMINUM SCOOP

	PART #	DESCRIPTION
	500480	45 oz Scoop

FERRULE CRIMPER

	PART #	DESCRIPTION
	5111A	Manually Operated Brass Ferrule Crimper

LARGE HOSE CRIMPER

	PART #	DESCRIPTION
	860	For crimping 1/2" to 1" (15mm to 25mm) ID hoses with larger OD's, from 11/16" to 1-1/2" (22mm to 40mm)

SLOTTED TUBES SCH 80 PVC

FEATURES:

- Distributors for use with distributor hub and lateral

	PART #	DESCRIPTION
	330541	1/2" MPT x 6" with 0.010 Slots
	330542	3/4" MPT x 6" with 0.010 Slots

**THIS PAGE IS
INTENTIONALLY
LEFT BLANK**